

nr. 39 40
july august 1978
u.k. 100p.
u.s.a. can \$3.00

elektor

summer circuits 78

double issue
with more than
100 circuits

pre- consonant

a high performance
disc preamp

consonant

a complete audio
control amplifier

luminant

a novel LED level
indicator

and:

- bicycle speedometer
- infrared link
- broadband rf amplifier
- fat millivoltmeter
- voltage-controlled
audio mixer
- disc jockey killer
- brake efficiency meter
- 2 m transmitter
- filters
- power supplies
- amplifiers
- test signal generators

and:

some 90 other circuits!

Austria	S 80
Belgium	F 110
Denmark	Kr 18
France	F 14
Germany	DM 7.50
Netherlands	DFL 8.50
Norway	Kr 18
Sweden	Kr 18 (incl. postage)
Switzerland	F 8.80



AUDIO

AGC microphone preamp 80
 amplifier for low-Z headphones . . . 6
 analogue delay line 1
 consonant 53
 digital audio mixer 57
 digital delay line 56
 disc preamp 75
 DJ killer 71
 FET audio amplifier 39
 limiter/compressor 96
 luminant 54
 micropower amplifier 22
 preconsonant 52
 stereo width control 33
 18 dB per octave high/lowpass filter . 27

CAR & BICYCLE

automotive voltmeter 16
 bicycle speedometer 50
 brake efficiency meter 94
 car ammeter 87
 car battery monitor 43
 car voltage/current regulator 69
 flasher bleeper 42
 power flasher 40

DESIGN IDEAS

bandwidth limited video mixer 92
 cheap crystal filter 58
 electronic variable capacitor 62
 hum filter using electronically simulated inductor 34
 improved 723 supply 29
 no-noise preamp 82
 selective bandpass filter 48
 simple CMOS squarewave generator . 9
 simple LS TTL squarewave generator . 8
 simple TTL squarewave generator . . . 7
 speedy rectifier 37
 stable start-stop-squarewave 49
 super-simple touch switch 14
 temperature-compensated reference voltage 99
 TTL-LC-VCO 20
 variable capacitance multiplier 63
 voltage mirror 36
 zero crossing detector 25
 18 dB per octave high/lowpass filter . 27

DOMESTIC

automatic aquarium lamp 79
 automatic shutter release 89
 back and front doorbell 35
 bat receiver 90
 burglar alarm 19
 cold shower detector 64
 electronic gong 13
 electronic soldering iron 73
 infra-red receiver 21
 infra-red transmitter 31
 liquid level alarm 38
 slide-tape synchroniser 102
 solid-state thermostat 67
 touch dimmer 100
 ultrasonic alarm indicator 47
 ultrasonic alarm receiver 45
 ultrasonic alarm transmitter 44

GENERATORS

AM/FM alignment generator 88
 digital spot sinewave generator 4
 frequency synthesiser 103
 sawtooth oscillator 18
 signal injector 41
 simple CMOS squarewave generator . 9
 simple LS TTL squarewave generator . 8
 simple TTL squarewave generator . . . 7
 sine-cosine oscillator 11
 squarewave oscillator 98
 stable-start-stop-squarewave 49
 TTL-LC-VCO 20
 288 MHz generator 5

HF

cheap crystal filter 58
 cheap r.f. amplifier 10
 FM IF strip 93
 frequency synthesiser controller . . . 95
 modulatable power supply 78
 VHF preamp 26
 wideband RF amplifier 23
 2 m transmitter 65
 288 MHz generator 5

MICROPROCESSORS

CMOS FSK modulator 72
 data bus buffer 85
 data multiplexer 86
 debouncer 46
 hexadecimal display 101
 programmable address decoder 97
 software Kojak siren 12
 stable-start-stop-squarewave 49
 supply failure indicator 3
 word trigger 61

MISCELLANEOUS

analogue-digital converter 32
 infra-red receiver 21
 infra-red transmitter 31
 many hands make light work 104
 metronome 15
 pseudo random running lamp 76
 quizmaster 70
 saw-song 51
 simple video mixer 74
 simple video sync generator 28
 squarewave-staircase converter 24
 stereo vectorscope 68
 touch controller 59

MODEL BUILDING

electronic gong 13
 glowplug regulator 66
 model railway lighting 91
 super cheapo NiCad charger 2

POWER SUPPLIES

improved 723 supply 29
 modulatable power supply 78
 symmetrical ± 15 V/50 mA supply . . 17
 temperature-compensated reference voltage 99
 voltage mirror 36
 0.30 V regulated supply 77
 78L voltage regulators 81

TEST

AM/FM alignment generator 88
 analogue-digital converter 32
 digital spot sinewave generator 4
 DIN cable tester 84
 FET millivoltmeter 60
 frequency synthesiser 103
 HF current gain tester 30
 IC counter timebase 55
 LEO X-Y plotter 105
 sawtooth oscillator 18
 signal injector 41
 sine-cosine oscillator 11
 squarewave oscillator 98
 timebase scaler 83
 word trigger 61

REGULAR FEATURES

advertisers index UK 34
 linear ICs UK 18
 market 7.95
 missing link 7.55
 selektor UK 20
 TUP-TUN-DUS-DUG UK 19

STOP PRESS

In the disc preamp (circuit 75) R2 is shown as 470 k. This should be 47 k.

selektor

Microprocessors and memories make their mark on communications

In most branches of electronics and telecommunications the key to many recent developments is the expanding use of digital techniques that employ a restricted number of simple, repetitive, coded waveforms instead of the almost infinite variations of the traditional analogue approach. The stimulus for much of this work has been the need to provide an interface with the digital computer, but the applications already extend far beyond the world of data processing.

In communications the use of coded digital waveforms is not a new concept. Telegraphy was founded on the Morse code, which if it had been devised recently might be regarded as just one form of a binary, non-return-to-zero digital code. But today it is in the field of distributed and automatic control rather than in signalling that the most exciting developments are taking place, based on microprocessors and integrated circuit memories.

In general, digital techniques provide the telecommunications engineer with signals that are highly resistant to noise and distortion during transmission and capable of unlimited regeneration. They thus can provide information and control signals that are easy to process, store and read out and that can be integrated with large or small computer systems.

Teletaxt and Viewdata

The ability of digital transmission systems to handle enormous amounts of data at speeds of hundreds of thousands of words a minute already has brought a new look to broadband communications systems, reaching even the consumer market in the form of the broadcast teletext services operated by the two British broadcasting authorities and the proposed interactive Viewdata system developed by the British Post Office. Such systems take advantage of the low cost of electronic memories and the associated electronic character generators by using them with domestic television receivers as visual display

units, with digitalised alphanumeric and simple graphical information organised for transmission by mini-computers.

A more recent development by the Independent Broadcasting Authority (1) is the Micro-ORACLE system, which has a maximum capacity of 60 pages rather than the 800 pages of the full teletext system. Micro-ORACLE is suitable for regional injection of pages into a broadcast system, or as a data display system in large operations centres.

But not all communication is concerned with the transmission of high speed data streams. There still is an important role for thin line radio systems, particularly HF and VHF radio communication systems carrying one to four voice channels, radio teleprinter traffic or manual telegraphy, both in civil and defence communications. With such systems even the smallest conventional computer seldom is justified.

Computer Enhancement

However, in recent months the micro-computer — a non volatile electronic memory and microprocessor — has begun to emerge as a powerful new tool for small communications systems. It provides technical operators with valuable new facilities, in much the same way as microelectronics revolutionised the world of pocket calculators. Electronic memories combined with processing — essentially providing the basic elements of a micro-computer — are a convenient means of introducing greater flexibility rather than complete automation and providing at relatively low cost a computer enhanced rather than a computer controlled system. The central processing unit of a microprocessor makes it possible for digital control circuitry to perform routine, time consuming tasks that can lead to boredom and inefficiency among human operators. This



Photo 1. The Plessey type PR 2250 communications receiver is designed principally for surveillance and monitoring applications. Covering the 10 kHz to 30 MHz range, this synthesised receiver is digitally controllable from either its front panel or from an externally supplied serial data stream. An internal 16 channel memory system provides instant recall of frequencies and mode of operations.

Photo 2. The Racal MA 1072 remote control unit carries all the controls and displays for the RA 1074 receiver.

approach differs from earlier forms of digital control in eliminating much of the need for wired logic for each specific task.

The range and scope of micro-processor applications to thin line radio communications is still evolving. But already it is clear that the incorporation into modern high performance LF/MF/HF communication receivers of such a memory, based on random access and programmable read only devices, can greatly ease the routine work of the technical operator by providing a frequency-synthesised receiver with a memory of ten or more frequencies. This enables the receiver to be instantly returned to any of the usual traffic channels by simple push button control.

At any time this form of electronic memory can be updated by means of a keypad to new channels, or used to tune the receiver to any frequency. Such a facility may be combined with a tuning control that allows the operator to search around the selected channel or fine tune to within a few Hertz. This technique may be extended by the use of a microprocessor to provide, for example, variable tuning rates of the frequency synthesiser as a form of automatic electronic 'gearing' of the control knob, or to search automatically over a given band of frequencies until the required signal is located.

Fewer Mechanical Components

The control functions of modern communication receivers more and more are becoming fully electronic, with fewer mechanically controlled components. This trend, combined with the use of microprocessors to form serial data modems makes possible the complete control of receivers from central operating consoles that may be many miles from the receiver. For instance, the receivers may be located deep in the countryside far from the high levels of electrical noise found in urban areas, yet the operator can sit in front of a full receiver control panel at a convenient traffic centre in the centre of a town. Positive, fast acting control can be provided at a cost much lower than was feasible with analogue remote control techniques. Microprocessor remote control systems with master and slave units are available from several British firms. Apart from the basic remote control facility, such systems make it possible for one man at a single set of controls to operate a whole bank of distant receivers, exactly as though the receivers were mounted at his console, with such additional features as the ability to select appropriate directional antennae. High frequency radio communication, unlike microwave systems, seldom

Selektor

tends itself to full automation, since the constantly changing and largely unpredictable ionosphere calls for repeated changes of frequency channels that do not follow an exact daily pattern. However, where a degree of automation is possible — for example in some specialised monitoring and surveillance applications — a microprocessor within the receiver can be linked into centralised computer control systems.

Continuous Coverage

A number of new items of communications equipment utilising these techniques have been introduced by British manufacturers. Plessey (2), for example, has demonstrated a new PR 2250 series of high performance communication receivers that give continuous coverage of the radio spectrum from 10 kHz to 30 MHz. The range incorporates a non volatile memory capable of instant recall of any 16 stored frequencies, including the appropriate mode, bandwidth and automatic gain control characteristics. A keypad not only allows the operator to enter and up date the memorized

information, but lets him change immediately to any frequency without touching the tuning knob. Even so, the tuning control then is available immediately for the operator to search around the new frequency with a tuning rate of either 20 or 1 kHz — with 10 Hz increments — per knob revolution. Although the front panel of the PR 2250 is not unlike a traditional communications receiver — apart from the provision of a keypad — there are no mechanical linkages to the main receiver circuits, which are in the form of demountable modules. The electrical connections are made via flexible printed wire strips, so that the receiver quickly can be broken down into a series of building blocks. This reduces the mean time to repair since a fault can be cleared by simply plugging in a replacement module.

In one screened module is a micro-processor unit that allows the receiver to be readily connected to the various forms of programmed control that are becoming a feature of modern monitoring systems.

Synthesised Remote Control

Clearly such digital techniques are best applied to a receiver capable of meeting the highest requirements in respect of dynamic range, frequency stability and low susceptibility to spurious responses or reciprocal mixing. Associated models are available providing full remote control.

Another company that has developed receiver systems featuring advanced digital techniques is Racal Communications (3). Its current range includes the RA 1784 synthesised remote control receiver for use in conjunction with the MA 1072 Score unit. Score is an acronym for Serial Control of Racal Equipment. Score provides a distant operator with a control panel virtually identical to that of the standard receiver

and capable of controlling all the variable facilities of the receiver. These include not only frequency, mode and bandwidth selection but such analogue functions as intermediate frequency gain and beat frequency oscillator tuning.

The system operates by scanning each of the parallel control wires in the MA 1072 unit in sequence and assembling the data into a composite serial 48 bit data frame with each controlled parameter allocated a number of data bits. In more complex installations up to 14 receivers may be controlled by a minicomputer supported by a floppy disc store and a visual display unit.

Flexible System

The availability of low cost visual display units, keyboard terminals and microprocessors raises many worthwhile possibilities in control, information retrieval and display systems for incorporation in communication systems. A flexible digital remote control system, the H 6800, has been developed by Marconi Communication Systems (4) to allow remote control of complex communications facilities over a single telephone line. Basically it comprises a visual display unit with keyboard, with an associated micro-processor unit, and it readily can be applied to a diverse range of control and monitoring requirements.

Further exploitation of the processor can provide a degree of automation of the complete system. For instance, modern fast tuning IIF transmitters could be used as radio sounding systems with control and evaluation by means of the processor to provide feedback of the ionospheric conditions. Similarly it could take over the organization of secure frequency agile operation, day/night frequency selection, antenna selection for specific circuits, transmitter fallback systems, and even routine logging operations.

The planning of such largely automated and unattended systems is a striking illustration of the impact of digital techniques and the application of micro and minicomputers to HF communications. And the marriage of low cost computing techniques with communications rapidly is opening up more possibilities, ranging from simple operator aids to highly complex automatic systems.

Key

- (1) IBA Engineering Centre, Crawley Court, Winchester, Hampshire, England.
- (2) Plessey Avionics and Communications, Martin Road, West Leigh, Havant, Hampshire, England.
- (3) Racal Communications Ltd, Western Road, Bracknell, Berkshire, England.
- (4) Marconi Communication Systems Ltd, Marconi House, Chelmsford, Essex, England.

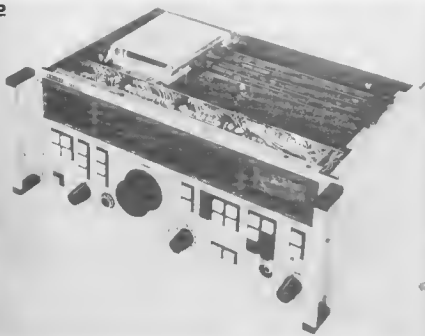

selektor

V-Cat

The MC 675 voltage-controlled attenuator (V-Cat) from Cadac is designed to solve the problem of controlling audio signal levels using a DC voltage or current. The device uses hybrid thick-film technology, which overcomes the distortion and dynamic range problems experienced with monolithic circuits.

The internal circuit of the V-Cat is shown in figure 1. It comprises a 'simulated potentiometer', which actually controls the signal, preceded and followed by buffer stages. The input buffer is designed for bridging 600 ohm lines and therefore has a medium input impedance (15 k). DC

bias components are incorporated into the input of the buffer, so the input signal must be AC coupled (capacitor or transformer) unless response down to DC is required. Pin 17 is provided to allow biasing of the crossover point of the input buffer. Crossover distortion can be minimised by sinking up to 100 μ A out of this pin to a more negative point.

The input balance point, pin 19, allows control voltage feedthrough to be minimised by either sinking or sourcing up to 100 μ A at this pin. The simulated potentiometer also has taps on the 'top' and 'wiper' which are impedance controlled and allow adjustment for maximum linearity.

The output stage will drive loads down to 47 k in parallel with not more than 100 pF, although lower impedances may be used if a restricted output voltage swing is acceptable. Depending on the output voltage swing required the supply voltage may be between ± 15 V and ± 22 V. The offset voltage of the output buffer may be adjusted by varying the DC potential at the output balance point, pin 6. This adjustment should be carried out with zero control current.

Table 1

PARAMETER	TEST CONDITIONS	MIN	TYP	MAX	UNITS
	TA = 25°C V = +22 V V = -22 V				
Zin	IC = 0 Vin = 0.775 RMS		15		k Ω
Zout	Between 0 V and pin 1 or pin 3		5		Ω
Vout	Output swing 100 K	(VCC-VEE) -2 V			
Attenuation Constant	IC = 0 - 8 mA Vin = 0.775 V δ = 20 Hz - 10 kHz		7.5	8	dB/mA
Final Attenuation	10 Hz - 10 kHz Vin = 0.775 V	90			dB
Frequency Response* at 1 dB down	IC = 20 mA IC = 0 - 5 mA Vin = 0.775 V RMS	DC		100	kHz
*LF Cut off	Point depends on Cin and Cout				
Rise time	IC = 0 - 5 mA Vin = 1 V pk - pk			1.5	μ s
Fall Time	IC = 0 - 5 mA Vin = 1 V pk - pk			1.5	μ s
Noise	Vin = 0 IC = 0 δ = 10 Hz - 10 kHz			25	μ V
Distortion	Vin = 0 IC = 5 mA δ = 10 Hz - 10 kHz			8	μ V
	Vin = 0.775 V RMS IC = 0 δ = 10 Hz - 10 kHz			.03	%
	Vin = 0.775 V RMS IC = 2.7 mA δ = 10 Hz - 10 kHz			.04	%
	Vin = 0.775 V RMS IC = 2.7 mA δ = 10 Hz - 10 kHz			.03	%
	Vin = 0.775 V RMS IC = 2.7 mA δ = 10 Hz - 10 kHz			.035	%

ABSOLUTE MAXIMUM RATINGS

VCC - VEE	Supply Voltage	-0.5 to +48 V
Vin	Input Voltage	VCC \geq Vin \geq VEE
Iin	Input Current	10 mA
Icont	Total Control Current	-0.10 to +50 mA (see note 1)
+1 supply	Supply Current +VE Rail	20 mA
-1 supply	Supply Current -VE Rail	20 mA
Ptot	Total Package Dissipation	600 mW
Iout	Output Current Peak	± 5 mA
Tstg	Storage Temp.	0°C to +70°C
Top	Operating Temp.	0°C to +70°C

Note 1.

Care should be taken to avoid taking either control input below earth potential as this will forward bias isolating diodes on the substrate and may result in over-dissipation in the device.

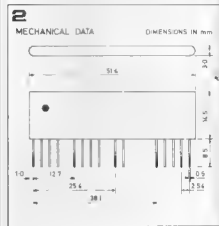
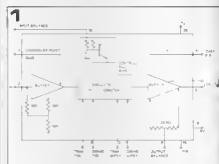

The test pin 4 is approximately one base-emitter voltage drop above the negative rail and should be left floating during normal use.

The electrical specifications of the MC 675 are given in table 1, whilst the mechanical dimensions are given in figure 2.

Cadac (London) Ltd.
141, Lower Luton Road
Harpenden, Herts AL5 1EL

analogue delay line

There are numerous applications requiring the use of an audio delay line, for example phasing and vibrato units, echo and reverb units, and sophisticated loudspeakers with active time-delay compensation. One of the simplest ways to achieve this electronically is to use an analogue (bucket brigade) shift register. There are various types on the market and a particularly interesting one is the Reticon SAD 512, which has 512 stages and a built-in clock buffer. The clock buffer enables it to be driven from a simple, single-phase clock circuit such as a CMOS multi-vibrator.

Figure 1 shows a delay line utilising the SAD 512. Input signals to the device must be positive with respect to the 0 V pin, so the AF input signal is first fed to an inverting amplifier, IC1, which has a positive DC offset adjustable by P1. The clock generator is an astable multivibrator using CMOS NAND gates (N1 and N2) and its frequency may be varied between 10 kHz and 100 kHz by means of P3. The clock buffer of the SAD 512 divides the clock input frequency by two, so the sampling frequency, f_c , of the SAD 512, varies between 5 kHz and 50 kHz. The delay produced by the circuit is $n/2f_c$, where n is the number of stages in the IC. The delay may therefore be varied between 5.12 ms and 51.2 ms. To obtain longer delays several SAD 512s may, of course, be cascaded very easily, since no special clock drive circuit is required.

To minimise clock noise the outputs from the final and penultimate stages of the IC are summed by R7, R8 and P2. However, if the circuit is to be used with the minimum clock frequency then clock noise will still be audible, and the lowpass filter circuit shown in figure 2 should be connected to the input of the delay line. This consists of a fourth-order Butterworth filter with a turnover frequency of 2.5 kHz and an ultimate slope of -24 dB/octave. Of course, if low clock frequencies are to be employed then the maximum frequency of the input signal must be restricted to half the sampling frequency. This can be achieved by connecting the filter circuit of figure 2 at the input of the delay line, as shown in figure 3.

To set up the circuit the clock frequency is lowered until it becomes audible. P2 is then adjusted until clock noise is at a minimum. The clock frequency is then raised and a

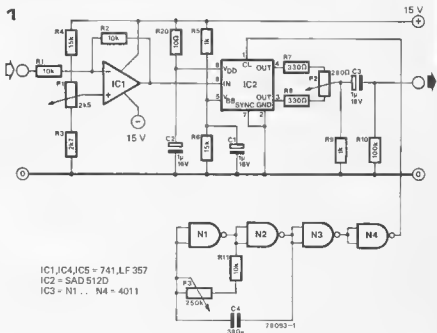

IC1, IC4, IC5 = 741, LF 357
IC2 = SAD 512D
IC3 = N1 .. N4 = 4011

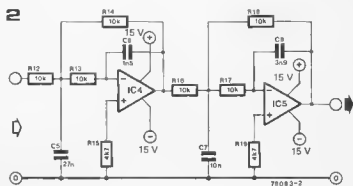

signal fed in. The signal level is increased until distortion becomes apparent, whereupon P1 is adjusted to minimise distortion. This procedure (increasing the signal level and adjusting P1) is repeated until no

further improvement is obtained. Alternatively, if an oscilloscope is available, P1 may be adjusted so that the waveform clips symmetrically when the circuit is overloaded by a large signal.

2 super cheapo NiCad charger

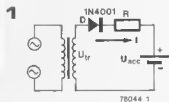

Nickel-Cadmium rechargeable batteries are gaining popularity in many applications, as they offer (in the long term) significant savings over dry (primary) batteries. Of course, the initial outlay involved is increased because a charger unit is required; however, this simple charger can be built using components that may be found in almost any constructor's junk box. For maximum life (number of charging cycles) NiCad batteries should be charged at a fairly constant current. This can be achieved quite simply by charging through a resistor from a supply voltage several times greater than the battery voltage. Variation in the battery voltage as it charges will then have little effect upon the charge current. The circuit consists simply of a transformer, diode rectifier and series resistor as shown in figure 1. The accompanying nomogram allows the required series resistor value to be calculated. A horizontal line is drawn from the transformer voltage on the

vertical axis until it intersects the required battery voltage line. A line dropped vertically from this point to intersect the horizontal axis then gives the required resistor value in ohms. As an example, the dotted line in figure 2 shows that if the transformer voltage is 18 V and a 6 V battery is to be charged then the required resistance value is 36 ohms. This resistance value is for a charging current of 120 mA and if other values of charging current are required the resistor value must be scaled accordingly, e.g. 18 ohms for 240 mA, 72 ohms for 60 mA etc. DI

may also be replaced by a bridge rectifier, in which case the resistance value for a given current must be doubled. The power rating (watts) of the resistor should be greater than $I^2 R$, where I is the charge current in amps and R the resistance in ohms. As the circuit does not incorporate any form of charge cutoff the charge rate must not be too great or the life of the battery may be reduced. As a general rule it is permissible to charge most NiCads at a current of 0.1C or less for several days, where C is the capacity of the battery in ampere-hours.

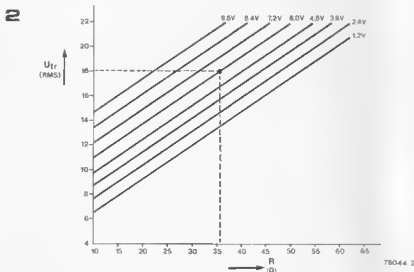

3 supply failure indicator

Many circuits, especially digital systems such as random access memories and digital clocks, must have a continuous power supply to ensure correct operation. If the supply to a RAM is interrupted then the stored information is lost, as is the time in the case of a digital clock.

The supply failure indicator described here will sense the interruption of the power supply and will light a LED when the supply is restored, thus informing the microprocessor user that the information stored in RAM is garbage and must be re-entered, and telling the digital clock owner that

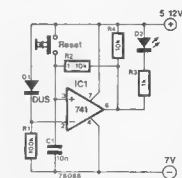

his clock must be reset to the correct time. When the supply is initially switched

on the inverting input of IC1 is held at 0.6 V below positive supply by D1. Pressing the reset button takes the non-inverting input of IC1 to positive supply potential, so the output of IC1 swings high, holding the non-inverting input high even when the reset button is released. LED D2 is therefore not lit. When the supply is interrupted all voltages, of course, fall to zero. Upon restoration of the supply the inverting input of IC1 is immediately pulled up to its previous potential via D1. However, C1 is uncharged and holds the non-inverting input low, so the output of IC1 remains low and D2 lights.

digital spot sinewave generator 4

Low-distortion spot-frequency sinewave generators are extremely useful for carrying out distortion measurements on audio equipment. Unfortunately most analogue circuits, which rely on thermistors or FETs for amplitude stabilisation, suffer from amplitude bounce due to the long time constant of the stabiliser circuit, which is necessary to achieve low distortion.

By synthesising a sinusoidal waveform digitally the problem of amplitude instability can be avoided. The circuit consists principally of a clock oscillator built around N1 and N2, a divide-by-32 counter IC3, and a 16-bit serial-in-parallel-out shift register comprising IC1 and IC2. The Q5 output of IC3 is connected to the Data input of IC1. For the first 16 clock pulses this output is high, so ones are loaded into the shift register and clocked through until all 16 outputs are high. Each output of the shift register is connected to P2 via a resistor, so as the shift register outputs go high the voltage across P2 varies in a series of steps. By suitable choice of resistor values the waveform thereby appearing across P2 can be made to be half a

Resistors:

R1 = 39 k
R2 = 8k2
R3,R30,R31,R37 = 1 M
R4,R10,R22,R28 = 6k8
R5,R29 = 330 k
R6,R26 = 27 k
R7,R27 = 180 k
R8,R24 = 5k6
R9,R25 = 150 k
R11,R23 = 120 k
R12,R20 = 12 k
R13,R15,R16,R17,
R19,R21 = 100 k
R14,R18 = 2k2
R32,R33 = 18 k
R34,R35 = 33 k
R36 = 10 k
P1 = 10 k preset potentiometer
P2 = 4k7 (5 k) preset potentiometer

Capacitors:

C1,C2,C3 = see text
C4 = 10 μ /25 V
C5 = 680 n
C6 = 100 n
C7 = 270 n

Semiconductors:

IC1,IC2 = 4015
IC3 = 4024
IC4 = 4069
IC5,IC6 = LF 356

cycle of a sinewave, from trough to peak. Since all four quadrants of a sinusoidal waveform are symmetrical it is a simple matter to synthesise the other half-cycle of the waveform, from peak to trough. From the 17th to the 32nd clock pulse the Q5 output of IC3 is low, so the shift register is loaded with zeroes and the voltage across P2 falls back to zero in an exact mirror image of its rise to the peak. On the 33rd clock pulse the Q5 output of IC3 again goes high and the whole cycle repeats. The waveform across P2 contains a large proportion of clock frequency components and also harmonic distortion due to the resistor values not being exactly correct, so these unwanted components are removed by a filter constructed around IC6. P1 is used to trim the clock oscillator frequency so that the frequency of the output sinewave is exactly at the centre of the filter's response. To do this the output from the filter is measured on an AC voltmeter and P3 is adjusted until maximum output is obtained. P2 may then be used to adjust the output level between zero and 6.5 V peak-to-peak.

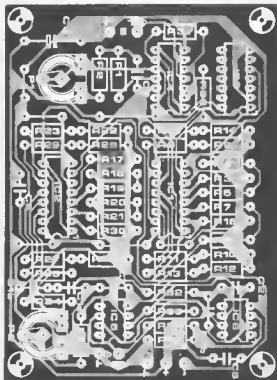
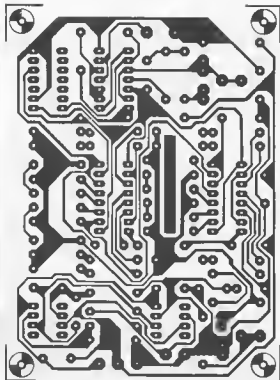

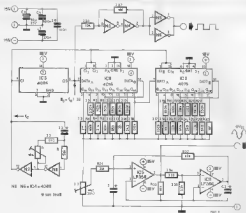

Capacitors C1 to C4 must be chosen to suit the required sawtooth output frequency f_0 and are given by $C1 = C2 = 9/\sqrt{f_0}$, $C3 = 1/f_0$ where f_0 is in Hz and the capacitor values are in pF.

For output frequencies between

30 MHz and 12 MHz the total harmonic distortion in the sawtooth signal is less than 0.01% (and typically 0.007%) at an output level of 5 V p-p.

Finally, an additional feature of the circuit is a squarewave output of the

same frequency as the sawtooth signal, which is derived from the Q5 output of IC3 using a Schmitt trigger (IC6) and a buffer comprising IC5 and IC6.

5 | 288 MHz generator

This 288 MHz generator was designed for use as a transmitter (transceiver converted) to show a two-stage (144 MHz) transmitter to operate on the 70 cm (432 MHz) band. During transmission the 288 MHz signal is mixed with the 144 MHz output of the transmitter the sum frequency being the desired 432 MHz signal. During reception the incoming 432 MHz signal is mixed with the 288 MHz signal the resultant 144 MHz difference frequency being fed to the transceiver input. For this system to work the 288 MHz signal must be extremely stable which makes crystal control mandatory. Unfortunately it is not possible to design a 288 MHz crystal oscillator, so instead a 96 MHz oscillator driving

a frequency tripler is employed. The oscillation is constituted around T1 and uses a 96 MHz third order quartz crystal. L3 connects across the crystal to neutralise the effect of the stray capacitance of the crystal case, which is necessary at this high frequency.

Transformers L1/L2 are tuned to exactly 96 MHz by means of C3/C4 and inductor C4. L2 couples the 96 MHz signal into the input of a balanced frequency tripler built around T2 and T3. To peak up the output of the tripler the test point shown next, which

Coil name	Winding details (all insulated unless stated)	Inductance (nH)	Q factor	Self resonant frequency (MHz)
L1	6	21	0.8	6
L2	7	28	0.8	6
L3	6	36	0.2	4
L4	2 turns - tapped	22	0.8	6
L5	2	31	0.8	6
L6	1	38	0.8	6
L7	0.5	29	0.8	6

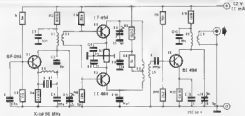

consists of a germanium diode and a millirohm resistor connected to C14. P1 and C9 are the adjustment for maximum deflection on the meter. The output of the frequency inverter is coupled out via L5 and C11 to a 288 MHz crystal amplifier (with crystal T4). This stage can also be peaked up by connecting the test signal to the output (L7) and adjusting C14 for maximum reading on the millimeter. The output power of the crystal is approximately 1 mW into a 50 ohm load (230 mV RMS, 300 mV peak).

When constructing the circuit normal RF practice should be followed. All leads should be as short as possible and the three set-ups of the generator (oscillator, mixer and output stage) should be screened from each other. All capacitors should be double-checked and inductors should be from a reputable manufacturer. All coils are discussed with their tap-off between turns, with the exception of L3, which is a loose wound and L5, which is wound between the turns of L4 such that the turns of the two coils



touch. L2 is wound next to the earth side of L1 and L7 next to the earth side of L6.

amplifier for low-Z headphones

Since headphones are usually connected to the loudspeaker output of the power amplifier, an attenuator. Although this represents the cheaper solution, it does suffer from two significant drawbacks: if the loudspeakers are also switched on when the headphones are being used, it is impossible to vary the signal level of the headphones independently of the loudspeakers; secondly, as a result of the output impedance of the attenuator, the damping factor of the system is reduced, which adversely affects the bass reproduction of the headphones. These problems can be avoided, however, by using the stereo output amp, which is connected via a stereo attenuator (P1, P2) to the tape output of the power amp. The tone controls will then have no effect upon the headphones, but in the case of stereo playback phones that is hardly an inconvenience.

The amplifier has an output power in excess of 1 Watt. The gain, which is determined by R4 and R5, can be varied, if desired, by

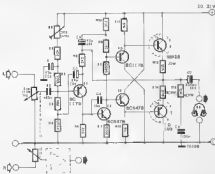

adjusting the value of R4. By means of P2 the voltage at the junction of R12 and R14 is adjusted to half

supply. The quiescent current is 50 to 100 mA, this can be varied by altering R8.

7 simple TTL squarewave generator

Using only a small number of TTL gates it is not difficult to construct a squarewave generator which can be used in a wide range of possible applications (e.g. as clock generator). The accompanying diagram represents the basic universal design for such a generator. The circuit is not critical, can be used over a wide range of frequencies, has no starting problems and is sufficiently stable for most applications. The frequency is not affected by supply voltage variations.

The oscillator frequency is determined by the RC network and the propagation time of the inverters (in this case three NANDs with their inputs connected in parallel). Since the propagation delay time of the IC is, in general, strongly influenced by the temperature and supply voltage, care must be taken to ensure that the propagation times have as little effect as possible upon the oscillator frequency. The output of each gate changes state twice per period of the oscillation signal, which means that, in all, one must account for double the propagation time of all three gates. To ensure that the oscillator frequency f_0 be more or less

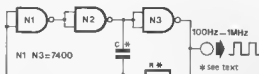

independent of variations in the temperature of the circuit and in the supply voltage, one must ensure that

$$f_0 \text{ is small compared to } \frac{1}{2 \cdot t_p \cdot n}$$

where t_p is the propagation time and n the number of inverters connected in series. In the case of the circuit shown here, t_p is approx. 10 ns and $n = 3$, so that as far as the oscillator frequency f_0 is concerned:

$$f_0 \ll \frac{1}{2 \cdot t_p \cdot n} = \frac{1}{2 \cdot 10 \cdot 3} = 16.6 \text{ MHz.}$$

The accompanying nomogram shows how f_0 changes with R . The value of the resistor R must not be smaller than that shown in the nomogram; for example, for $C = 100 \text{ nF}$, R must not be less than 100 Ω . A variable squarewave oscillator can be obtained by replacing R with a 2.5 k potentiometer in series with a fixed resistor of the minimum permitted value.

A universal squarewave generator of

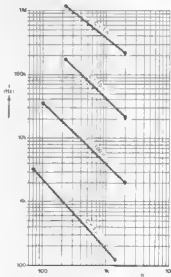
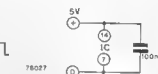

this type can also be constructed using Low Power Schottky TTL or CMOS ICs; both these possibilities are discussed below.

8 simple LS TTL squarewave generator

The design of this squarewave generator is identical to that of the circuit described above, with the exception that it employs an IC from the increasingly popular Low Power Schottky (LS) TTL series, rather than a conventional TTL IC. Since the electrical characteristics of LS TTL devices differ from those of standard TTL ICs, the relationship between the oscillator frequency and the values of R and C will also be difficult, whilst an extra resistor is required for the circuit to function satisfactorily.

The circuit will generate a squarewave with a frequency between 20 Hz and 1 MHz. The nomogram once again shows the frequencies obtained for various values of R and C . As was the case in the above circuit, there is a minimum permissible value for R (680 Ω). To obtain a variable squarewave generator, R should be replaced by a 5 or 10 k potentiometer in series with a fixed resistor of 680 Ω .

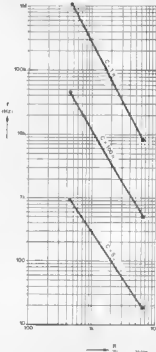
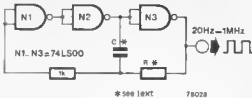

simple CMOS squarewave generator 9

In addition to standard- and Low Power Schottky TTL devices, there is, of course, no objection to using a CMOS IC in the basic squarewave generator circuit. The revised graph of frequency against R and C is shown in the accompanying nomogram. The frequencies are plotted for a nominal supply voltage of 12 V, however, this voltage is not critical, and a supply of between 5 V and 15 V may in fact be used. The frequency range of the circuit runs from 0.5 Hz to 1 MHz.

The minimum permissible value of R is 22 k. To obtain a variable squarewave oscillator, R should be replaced by a fixed value resistor of 22 k in series with a 1 M potentiometer. Both the buffered and unbuffered versions of the 4011 may be used.

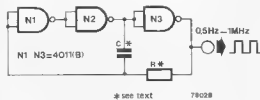

* see text 78028

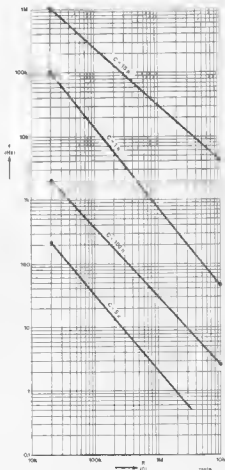

cheap r.f. amplifier 10

It is possible to reduce distortion in r.f. amplifiers by employing negative feedback. When using this technique, however, it is important that the feedback network does not cause mismatching between input and output, which basically means that transformer coupling should be used. Using this approach it is possible to accurately match the input and output impedances whilst also achieving a low noise figure. A prototype model which used a BF 199 gave the following results:

bandwidth (-3 dB): 0.11 - 40 MHz

gain: 11 dB

two-tone test: $P_{OUT} = +10$ dBm/tone, third-order IM - 40 dB with respect to one output signal.

noise: 15 dB

The relatively poor noise figure is due to the type of transistor which was used. Better results can be obtained using CATV transistors (BFW 30, BFW 16, BFR 94, BFR 65,

BF 64 etc.) which give a low noise figure despite their (relatively) high collector currents

Lit: CQ DL 2/78 pp. 64, 65

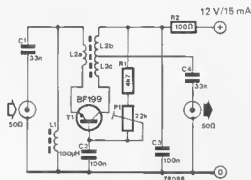

L2a = 2 turns
L2b = 8 turns
L2c = 22 turns

78088

11 sine-cosine oscillator

There are a number of applications which require two sinewave signals that are of the same frequency but 90° out of phase, i.e. a sine signal and a cosine signal. Such signals are used in SSB and quadrature modulation, electronic generation of circles and ellipses and transformations between rectilinear and polar coordinates. Sine and cosine signals can be obtained from a quadrature oscillator which consists of two integrators connected as shown. A1 is connected as a non-inverting integrator, while A2 is connected as an inverting integrator. Why this circuit should produce a sine and cosine signal may not be immediately apparent, but is easily explained. At output B appears a signal which is a function of time, $f(t)$. Since this is minus the integral of the signal at A it is obvious that the signal at A is minus the differential of the signal at B i.e. $-\frac{df}{dt}$. Similarly, the input

signal to integrator A1 is the differential of the signal at A, i.e. $-\frac{d^2f}{dt^2}$.

However, the input signal to A1 is the output signal from A2, i.e. $f(t)$. Therefore $-\frac{d^2f}{dt^2} = f(t)$. These conditions are satisfied by sine and cosine signals, since, if $f(t) = \sin \omega t$ (output B)

$$\frac{d(\sin \omega t)}{dt} = \cos \omega t \text{ (output A)}$$

$$\frac{d(\cos \omega t)}{dt} = \frac{d^2(\sin \omega t)}{dt^2} = -\sin \omega t = -f(t)$$

Output A therefore produces a cosine signal and output B a sine signal.

P1 is used to adjust the loop gain of the circuit so that it oscillates reliably. If, due to component tolerances, the circuit does not

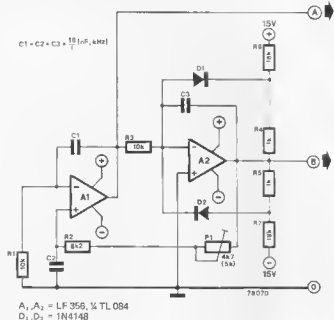

A₁, A₂ = LF 356, ¼ TL 084
D₁, D₂ = 1N4148

oscillate at any setting of P1, it may be necessary to increase its value to 10 k. The signal amplitude is stabilised by D1, D2 and R4 to R7. The frequency of oscillation can be altered by substituting different values of capacitor for C1 to C3, calculated using the equation given.

Literature.

Texas Instruments Application Notes.

12 software Kojak siren

The number of possible applications for the SC/MP microprocessor are legion, however thanks to the DELAY instruction it is particularly easy to use 'SCAMP' to generate low frequency signals. The following programme for a police siren is a good example of this facility. A periodic signal is obtained by repeatedly setting and resetting a flag. The siren effect is produced by using DELAY instructions to vary the interval between set and reset. As it stands, the accompanying programme will generate a double-siren effect, similar to that of American police cars. If a 'normal' siren is desired, the contents of

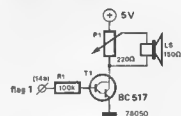

address 0F12 should be altered to 90. The signal is rendered audible by means of the loudspeaker interface shown. This is an extremely simple little circuit which is connected to flag 1 of the SC/MP. The volume is controlled by means of P1.

```

0F00 C4FF LDI FF
0F02 8F00 DLY 06 set flag 1
0F04 C402 LDI 02
0F06 07 CAS
0F07 C4FF LDI FF
0F09 3F00 DLY 08 reset flag 1
0F0B C400 LDI 00
0F0D 07 CAS
0F0E 8BF9 DLD
0F10 8BF0 DLD
0F12 9CEC JNZ (JMP 90EC for siren)
0F14 C400 LDI 00
0F16 8F00 DLY 00
0F18 C402 LDI 02 set flag 1
0F1A 07 CAS
0F1B C400 LDI 00
0F1D 8F00 DLY 09
0F1F C400 LDI 00 reset flag 1
0F21 07 CAS
0F22 ABF9 ILD
0F24 ABF0 ILD
0F26 9CEC JNZ
0F28 90D6 JMP
    
```

electronic gong 13

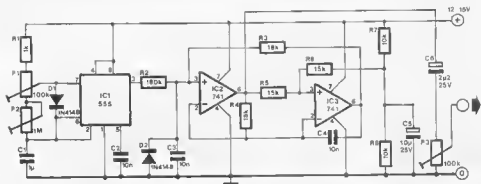

This circuit will simulate the sound of a bell or gong and may be used as a replacement for conventional bells in such applications as doorchimes, clocks etc.

The circuit consists of a resonant filter built around IC2 and IC3 which will ring at its resonant frequency when a short pulse is fed to the input. In this circuit the trigger pulses are provided by a 555 timer connected as an astable multivibrator, but other trigger sources may be used depending on the application.

The character of the sound is influenced by two factors; the Q of the filter, which may be varied by changing the value of R2, and the duration of the trigger pulse, which may be adjusted using P1. The repetition rate of the trigger pulses, i.e. the rate at which the gong is 'struck', may be varied using P2. In order to drive a loudspeaker the output of the circuit must be fed through an audio amplifier. The output level may be varied from zero to about 5 V by means of P3.

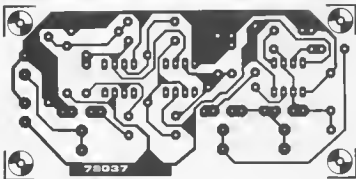
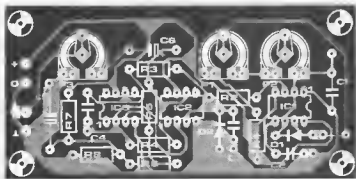

super-simple touch switch 14

Although there is a plethora of designs for touch switches, it is always a challenge to come up with a design that is simpler than previous versions. While most latching touch switches use a pair of NAND gates connected as a flip-flop, this circuit uses only one non-inverting CMOS buffer, one capacitor and a resistor. When the input of N1 is taken low by bridging the lower pair of touch

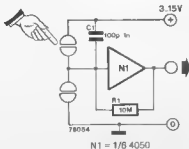

contacts with a finger, the output of N1 goes low. When the contacts are released the input of N1 is held low by the output via R1, so the output remains low indefinitely. When the upper pair of contacts is bridged the input of N1 is taken high, so the output goes high. When the contacts are released the input is still held high via R1, so the output remains high.

15 metronome

B. v.d. Klugt

Those of our readers who have experienced the pleasures of piano lessons during their childhood, will doubtless be all too familiar with the sound of a metronome. This is a clockwork instrument with an inverted pendulum, which can be set to beat a specific number of times per minute, the loud ticking thereby indicating the correct speed at which the passage of music should be played. Although mechanical metronomes are still used almost universally, it is, of course, also possible to achieve the desired effect electronically.

The circuit for an electronic metronome described here is distinguished, not by any revolutionary new features, but by its extreme simplicity and excellent stability. N1 to N3 form an astable multivibrator. By means of P1, the frequency of its output signal can be varied between 0.6 and 4 Hz, whilst the pulse width can be adjusted by means of P2. The latter control modifies the sound of the beat between a short 'dry' tick and a longer, fuller tone. The volume control is provided by P3, which varies the peak current through the loudspeaker between 0.5 A and 50 mA. At low resistance values of P3, the resultant large current places fairly heavy demands upon the transistor, and hence a Darlington pair was chosen. Thanks to the low duty cycle, the average current drawn by the circuit is extremely small, so that an

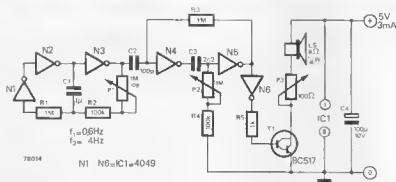
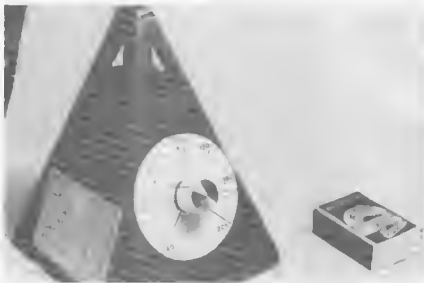

ordinary 4.5 V battery will suffice for the power supply. The accompanying photo shows

how the characteristic shape of the metronome can still be conserved in the electronic model.

16 automotive voltmeter

Although vital for satisfactory operation of the vehicle, the car battery is often taken for granted and rarely receives adequate maintenance. As a battery ages, its ability to store charge for long periods gradually decreases. The inevitable result is that one morning (usually in the depths of winter) the car fails to start.

The solid-state voltmeter described in this article allows continuous monitoring of the battery voltage so that incipient failure can be spotted at an early stage. The circuit will also indicate any fault in the car voltage

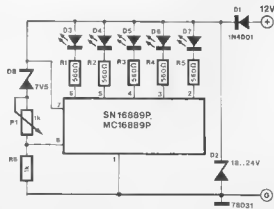

regulator which may lead to overcharging and damage to the battery. Battery voltage can, of course, be measured using a conventional moving-coil voltmeter. However, as only the voltage range from about 9 to 15 V is of interest, only the top third of the scale of a 15 V meter would be used, unless a 'suppressed zero' facility was added. Moving coil meters are also fairly delicate mechanically.

A better solution is to use a solid-state voltmeter which will indicate the voltage on a column of LEDs. Various ICs are available which perform this function. However, the 12 or 16 LED display offered by ICs such as the Siemens UAA 180 and UAA 170 is not required in this application, so an IC was chosen

which will drive only five LEDs, the Texas SN 16889P. This IC provides a thermometer-type indication. The complete circuit of the voltmeter uses only this IC and a handful of other components, since the IC will drive the LEDs directly. Diodes D1 and D2 provide protection against reverse polarity and transients on the supply line, while D8 offsets the zero of the meter so that it only begins to read above about 9.5 V. The circuit is calibrated using P1 so that the LEDs extinguish at the voltages shown in the accompanying table.

LED D7 will be extinguished below about 15 V. If this LED is lit when the circuit is fitted in the car then the charging voltage is too high and the car voltage regulator is at fault. A

red LED should be used for D7. D6 indicates that the battery is fully charged, and a green LED should be used for this component.

D5 indicates that the battery voltage is fairly o.k., but the battery is not fully charged - a cautionary yellow LED can be used here. D4 and D3 indicate that the battery voltage is unacceptably low, and red LEDs should again be used for these components.

Table. Voltages below which the LEDs extinguish

D7	15 V
D6	13.5 V
D5	12 V
D4	11 V
D3	9.5 V

± 15 V/50 mA supply

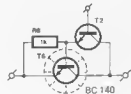
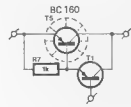
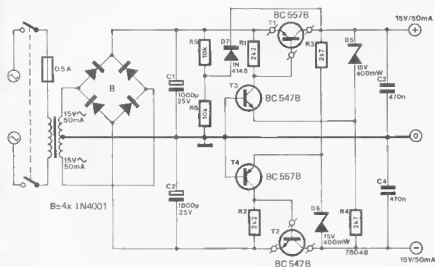

Although IC voltage regulators have now largely displaced discrete component designs, this circuit offers a considerable cost advantage over an IC regulator. In fact the component cost of the regulator section is only about 75 p!

Operation of the circuit is extremely simple. The centre-tapped transformer, bridge rectifier and reservoir capacitors C1 and C2 provide an unregulated supply of about ± 20 V. The positive and negative regulators function in an identical manner except for polarity, so only the positive regulator will be described in detail.

The positive supply current flows through a series regulator transistor T1. 15 V is dropped across zener

diode D5, the upper end being at about +15 V and the lower end at 0 V. Should the output voltage of the regulator tend to fall then the lower end of D5 will fall below 0 V and transistor T3 will draw more current. This will supply T1 with more base current, turning it on harder so that the output voltage of the regulator will rise. If the output voltage of the regulator is too high then the reverse will happen. The potential at the lower end of D5 will rise and T3 will draw less current. T1 in turn will tend to turn off and the supply voltage will fall. The negative supply functions in a similar manner. Since D5 and D6 receive their bias from the output of the supply, R5, R6 and D7 must be included to make

the circuit self-starting. An initial bias of about 10 V from the unregulated supply is provided by these components. Once the output voltage of the supply has risen to its normal value D7 is reverse-biased, which prevents ripple from the unregulated supply appearing on the output.

Using inexpensive small-signal transistors such as the BC 107/BC 177 family or equivalents, the maximum current that can safely be drawn from the supply is about 50 mA per rail. However, T1 and T2 may be replaced by higher power Darlington pairs to obtain output currents of 500 mA.

18 sawtooth oscillator

Using a simple CMOS analog switch it is a simple matter to construct a sawtooth relaxation oscillator as shown in figure 1. C_1 charges via R_1 until the threshold voltage of the switch (approximately 2/3 supply) is reached. The switch then 'kicks' and C_1 discharges through S_1 and R_2 until the low threshold of the switch is reached, when S_1 opens and the cycle is repeated. To avoid loading the output the sawtooth output must be connected to a load impedance considerably greater than R_1 . Alternatively a FET source follower may be used as a buffer. An ICL4066 IC contains four analogue switches (it is possible to construct four oscillators around a single chip). Another possibility is to add a second CMOS switch S_2 which closes when S_1 closes, thereby connecting R_3 to apply and generating a short, negative pulse. The frequency of oscillation may be varied by altering R_1 whose value may be between 1 k and 100 k. The supply voltage may be between 3 V and 10 V, and the highest oscillation frequency that can be obtained is about 12 MHz (with a 10 V supply). Since C_1 is charged through a resistor the sawtooth is generated by the capacitor not linear, but has an exponential curve. If a linear sawtooth is required then R_1 may be replaced by a current source as shown in figure 2a. A further possibility is to change controlled current, and hence the oscillator frequency, thus making a simple VCO. Alternatively a current mirror may be used as shown in figure 2b in which the current source becomes a current-controlled oscillator.

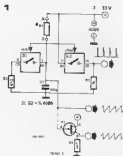

2a



2b



19 burglar alarm

For anybody who wears the name supplied this type of burglar alarm what about Radar?TM Philips/Mellor supply a Gate oscillator module, type LL8305 which oscillates at approximately 4 GHz. One of the circuits in an extensive application note on this simple Gate radar motion detector reproduced here. The basic principle as we all know by now, a moving

object within the field of the 4 GHz transmitter will reflect a signal at a slightly different frequency (Doppler shift). The frequency difference can be obtained from the formula $\Delta f = 2 f_0 v/c$ where v is the speed of the object with respect to the transmitter, f_0 is the transmitted frequency and c is the speed of light (3×10^8 m/s). The difference frequency in this case

will be in the low-frequency audio range approximately 700 Hz. This frequency is composed of a direct and a Doppler shifted frequency and amplified by a low frequency amplifier consisting of T1. T2 The output from T2 is used to trigger a monostable multivibrator (T4, T5) with a period time of 10 seconds. The combination of a bipolar transistor and a FET may appear unusual, but it makes it easier to

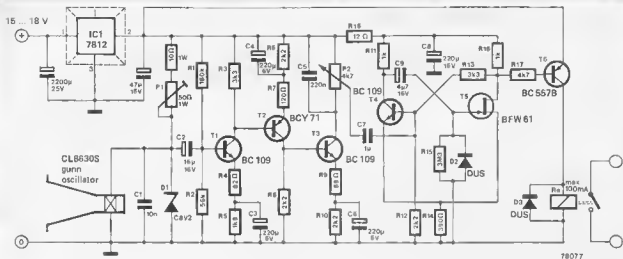

obtain the long period required. The output from the monostable is used to turn on T6, causing the relay to pull in.

The sensitivity of the circuit can be set by means of P2. A range of up to 10 m (30 feet) can be achieved, which should prove adequate for most purposes. It should, however, be noted that this type of alarm system is notorious for 'false alarms' if the sensitivity is too high. Not only flies or moths may be detected, but even a sudden draught caused by an open window!

Apart from the sensitivity, which of course can be set according to personal taste (if not bitter experience), the only other calibration point is P1. This sets the operating point of the Gunn oscillator. Initially, P1 should be set to maximum resistance. The top end of the Gunn oscillator is temporarily disconnected from point A in the circuit, and a multimeter is connected in series. The test leads should not be unnecessarily long, and they should be tightly twisted. The meter is set to a suitable current

measuring range and P1 is adjusted until the current consumption of the oscillator is 120 mA. After re-connecting the oscillator to point A the circuit is ready for use. As a final note, R17, T6, D3 and the relay will not always prove necessary; either R11 or R16 may be replaced by a reed relay if only a low alarm current is to be switched. *Philips/Mullard Application notes for CL8630S*
Note. In the UK Home Office type approval must be obtained for microwave intruder alarms.

TTL-LC-VCO 20

This Voltage Controlled Oscillator (VCO) uses only two TTL gates or inverters, so it may prove useful in digital circuits where one or more TTL ICs are not fully utilised. Any type of TTL gate that can be wired as an inverter can be used (NANDs, NORs or inverters).

Basically, the circuit is an extended version of the well-known two-gate RC oscillator. However, in this case the main frequency-determining element is an LC resonant circuit consisting of L1, C2 and D1. Since D1 is a varicap, a control voltage applied to R3 will alter the resonant frequency of the circuit. A control voltage range of 0...5 V corresponds to an oscillator frequency range of 7.5...9.5 MHz. The output is, of course, TTL compatible.

With the component values shown, the circuit is only suitable for TTL gates: for one thing, the frequency is too high for CMOS. However, the same principle can be used with CMOS provided the circuit is re-designed.

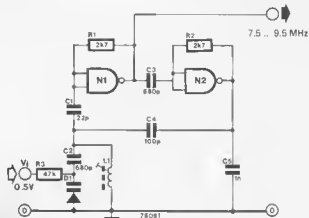

N1, N2 = 7400
 D1 = MVAM 1 (Motorola)
 L1 = 18 turns 21 SWG (1 mm) enamelled copper wire on a 3 mm dia. former

The performance of the circuit is not particularly good - the linearity, for instance, is mediocre - but it is reliable and cheap. One possible

application is where a clock frequency is required that can be varied as a function of logic states elsewhere in the circuit.

21 infra-red receiver

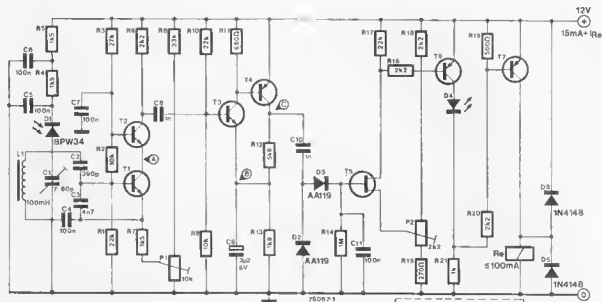

T1, T2, T3 = BF 494, BF 194
 T4, T6, T7 = BC 857B, BC 177B
 T5 = BF 256A, B

A = 4.8 V
 B = 3 V
 C = 8.8 V

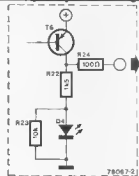

This IR receiver can be used with the complementary transmitter described elsewhere in this issue. The IR signal is received by photodiode D1. This diode is reverse-biased (its bias voltage being decoupled from noise on the supply line by R4, R5, C5 and C6) and its leakage current varies with changes in incident light. To enable the receiver to be sensitive without being interference-prone it must be made selective, so a tuned circuit L1/C1 is included. The bandwidth of the receiver is 100 Hz when tuned to 24 kHz. It is not possible to reduce the bandwidth further since the tuning is affected by the capacitance of D1, which is light dependent. If the bandwidth were too narrow the receiver could drift off tune due to this effect. T1 and T2 form a cascode amplifier with negative feedback, whilst T3 and T4 provide further gain. The amplified signal is then detected by D2 and D3, and the resulting DC voltage is further amplified by T5, T6 (which drives an indicator LED, D4) and T7, which energises a relay. By a slight modification to the stage

around T6 it is possible to link the receiver to the ultrasonic alarm indicator described elsewhere in this issue to make an infra-red alarm system. T7 and associated components may then be omitted (see figure 2). To align the transmitter and receiver the following procedure should be adopted:

1. Switch on the transmitter and check that it is drawing a current of between 50 and 100 mA.
2. Set C3 of the transmitter circuit to its mid-position (vanes half-closed) then switch off the transmitter.
3. Turn the wiper of P1 fully towards R8 and the wiper of P2 fully towards R15. The LED, D4, should now light, which indicates that the first stage of the receiver has begun to oscillate.
4. Adjust P2 until the LED only just lights.
5. Adjust P1 until the LED extinguishes.
6. Switch on the transmitter and move the transmitter towards the receiver until D4 begins to flicker.

Adjust C1 of the receiver until D4 glows continuously. Increase the distance between transmitter and receiver until D4 again begins to flicker and readjust C1. Repeat until maximum range is obtained. It may be that the transmitter frequency is outside the receiver tuning range, in which case the value of C3 may need to be changed slightly to bring the transmitter frequency within the adjustment range of C1. Using the LD241/1 in the transmitter and BPW34 in the receiver it should be possible to obtain an operating range of at least 10 metres without any special optical system or shielding of the photodiode from ambient light. If a simple lens system and shielding tube for the BPW34 is employed then much greater ranges may be achieved. The receiver should operate from a stabilised 12 V supply capable of supplying 12 mA plus the rated relay current. Any of the common 12 V IC regulators should prove suitable for this task. (see circuit 31)

micropower amplifier 22

This amplifier has been specially designed for use with 'alternative energy sources' such as solar cells, biological fuel cells, etc. These types of energy source characteristically have a low and variable output voltage and a high output resistance. The amplifier will operate reliably from supply voltages between 3 V and 20 V having source resistances as

$$\text{high as } \frac{U_{\text{supply}} (V)}{2} \frac{(k\Omega)}{(mA)}$$

The power which the amplifier can supply is, of course, dependent on the supply voltage and its source resistance, as can be seen from the accompanying table. The quiescent current consumption of the amplifier is between 1 mA and 1.5 mA, the exact value depending on the type of transistors used. Should the quiescent current fall outside this range it will be necessary to vary the value of R9.

As is apparent from the table, the amplifier performs best with high impedance loudspeakers. As speakers with impedances as great as 200 ohms are not readily obtainable, the alternative is to use a lower impedance speaker with a matching transformer. For example an 8 ohm speaker could be used with a transformer having a ratio of approximately 5:1. Although the output level of the amplifier is not exactly ear-splitting, it is nonetheless sufficient when used with a reasonably efficient loudspeaker in a quiet room. The voltage gain of the amplifier is approximately 50 and the 3 dB bandwidth is about 300 Hz to 6 kHz.

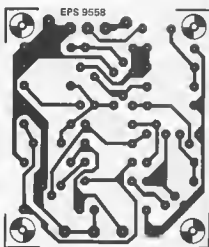
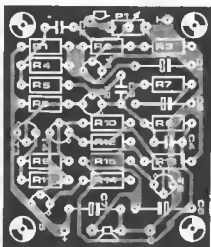
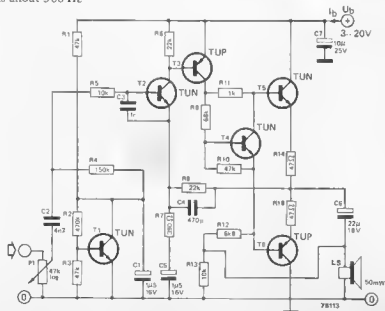
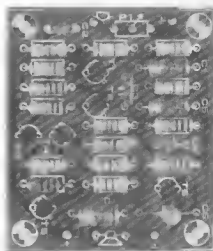

Table 1.

$U_b (V)$	$P_0 (mW)$	$I_b (mA)$	$R_{LS} (\Omega)$
20	10	19	8
20	20	19	16
20	40	7	200
9	4	11	8
9	6	9	16
9	10	3.8	200
3	9.2	2.4	8
3	0.3	2.2	16
3	0.5	1.4	200



23 wideband RF amplifier

This design for an RF amplifier has a large bandwidth and dynamic range, which makes it eminently suitable for use in the front end of a shortwave receiver. The design operates without negative feedback since, if an amplifier with feedback overloads, distortion products can be fed back to the (aerial) input via the feedback loop and re-radiated. However, good linearity is achieved by employing a device which has an inherently linear transfer characteristic, in this case a dual-gate MOSFET with both gates linked. With the 3N211 used in this circuit the transconductance of the device is constant at about 14 mA/V provided the drain current is greater than approximately 12.5 mA. The MOSFET is used in a common-

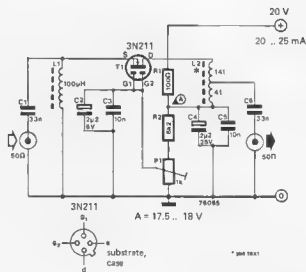

Table 1

Typical characteristics of the RF amplifier

gain: approximately 10 dB

3 dB bandwidth: 4 MHz to 55 MHz

noise figure: less than 5 dB

two-tone test:

output power for third order

IM distortion at -40 dB with respect to one tone: +22 dBm/100

gate configuration, with P1 used to set the drain current at around 20 mA. One home-made inductor is employed in the circuit, L2, which is wound on a Philips/Mullard type 4312-020-31521, two-hole ferrite bead, sometimes referred to as a 'pig's nose ferrite bead'. 14 turns of 31 SWG (0.3 mm) enamelled copper

wire are wound through one hole of the bead and four turns are wound through the other hole, one end of each winding being joined to form the tap which connects to C6. P1 should be adjusted so that the voltage at the test point shown in figure 1 is between 17.5 V and 18 V.

24 squarewave-staircase converter

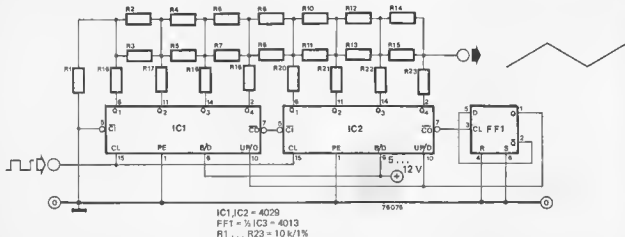

IC1, IC2 = 4029
FF1 = 1/2 IC3 = 4013
R1 ... R23 = 10 k/1%

This circuit can be used to generate an up-down staircase waveform with a total of 512 steps per cycle. IC1 and IC2 are two four-bit up-down counters connected as an 8-bit counter, with an R-2R D-A ladder network connected to the outputs to

convert the binary output codes to a staircase waveform. When a squarewave is fed to the clock input the circuit will count up until the counter reaches 255, when the carry output will go low and clock FF1. The circuit will then

count down until zero is reached, when the carry output will again clock FF1 and so on. To ensure that the staircase steps are of equal height 1% tolerance resistors should be used for R1 to R23.

zero crossing detector 25

This circuit will detect precisely the negative-going zero-crossing point of an AC waveform, but requires only a single supply voltage, unlike zero crossing detectors using op-amps. N1 and N2 are Schmitt triggers connected to form a monostable multivibrator with a period of about 15 ms. P1 is adjusted so that when the input voltage falls to zero the voltage at the input of N1 is equal to the low-going threshold of the Schmitt trigger. The output of N1 thus goes high and the output of N2 goes low. C1 holds the second input of N1 below its positive-going threshold for about 15 ms, during which time the output of the circuit will remain low, even if noise pulses on the input waveform should take the first input of N1 high. When the input signal goes positive the first input of N1 is taken above its positive-going threshold. Note that this occurs after the positive-going zero-crossing point due to the

hysteresis of the Schmitt trigger. Subsequently the second input of N1 goes high due to C1 charging through R3. The circuit then resets and the output of N2 goes high. The output of N2 is thus an asymmetrical squarewave whose negative-going edge occurs on the negative-going zero-crossing point of the input waveform and whose positive-going edge occurs sometime during the positive half-cycle of the input waveform. The negative-going edge of the waveform is independent of the amplitude of the input signal and occurs always at the zero-crossing point. However, it does vary slightly with supply voltage, so this should be stabilised. If a higher supply than 15 V is used then R4 and D2 must be included, otherwise the IC may be damaged. To calibrate the circuit an oscilloscope is desirable so that P1 may be set exactly for the zero-crossing point. Alternatively, if a

scope is not available, C1 should be temporarily disconnected and the output of N2 monitored on a multimeter.

In table 1 look up the voltage corresponding to the RMS input voltage and supply voltage and adjust P1 until this voltage registers on the meter, e.g. with a 10 V supply and a sinewave input of 5 V RMS P1 should be adjusted until the meter reads 4.47 V.

R1, D1 and the input protection diodes of N1 protect the circuit against input voltages up to 220 V (RMS, sinewave input). At this level the maximum permissible current of 10 mA flows into N1 and 1.5 W are dissipated in R1. If higher input voltages are to be used or less dissipation is desirable then the values of R1, R2 and P1 should be increased, keeping them in the same ratio.

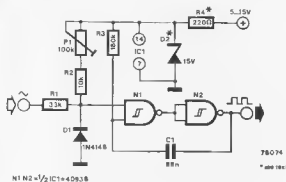

Table 1

Input voltage (RMS sine)	Supply voltage		
	5 V	10 V	15 V
2 V	2.24	3.49	—
3 V	2.33	4.09	5.18
4 V	2.37	4.33	5.91
5 V	2.40	4.47	6.26
6 V	2.42	4.56	6.48
7 V	2.43	4.63	6.64
8 V	2.44	4.67	6.75
9 V	2.44	4.71	6.83
10 V	2.45	4.74	6.90

N1 N2 = 1/2 IC1 = 4063 B

78074

* see 18x1

VHF preamp 26

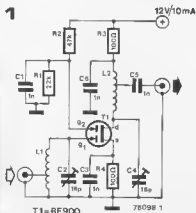

Designing a preamp for the VHF waveband (around 100 MHz) is not always an easy matter. This circuit, however, is both relatively simple to use and is inexpensive. It has the advantage of a fairly large bandwidth (2 MHz) and good noise figure (2.5 dB). The preamp has a large dynamic range and a gain of 20 dB at a frequency of 144 MHz. L1 and L2 are air-cored coils with an internal diameter of 6 mm and consist of 4 turns of 1 mm silver-plated copper wire. L1 is tapped one turn from the earthy end, whilst L2 has a tap one turn from the end

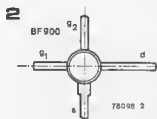

nearest R3. Ceramic types are recommended for the four 1 n capacitors.

27 18 dB per octave high/lowpass filter

Calculating the correct RC values for high- and lowpass filters can be something of a chore and is often regarded by amateur constructors as a subject that is best left well alone. This is especially true the more complicated the filter and the steeper the slope of the filter becomes. That being the case, the following circuit for a third order (i.e. with a slope of 18 dB per octave) high/lowpass Butterworth filter, together with the accompanying nomogram which supplies the correct RC values for any given turnover point, should prove extremely useful. The circuit shown is for a lowpass filter, however by changing over the position of the resistors and capacitors a highpass filter is obtained. The beauty of the circuit lies in the fact that all the resistors and capacitors have the same respective value. Either operational amplifiers or emitter followers may be used as voltage

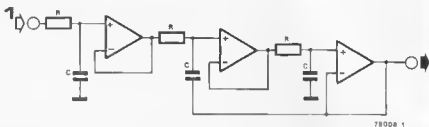

followers.

Normally, to find the turnover frequency of a filter (i.e. the point at which the output voltage of the filter is 3 dB down on the passband response) one uses the equation f_0 (the turnover point) = $1/(2\pi RC)$. However one can forget about having to go through these calculations by using the accompanying nomogram. The turnover points are displayed along the horizontal axis, whilst the corresponding values for C are shown along the vertical axis. Furthermore, a number of resistance values are also

indicated by the diagonal lines running across the nomogram.

To use the nomogram one first draws an imaginary vertical line through the desired turnover point. An imaginary horizontal line is then drawn through the point at which the vertical line intersects with the desired resistance. The intersection of that horizontal line with the x-axis gives the correct value of C for the chosen turnover frequency. In the example shown (in dotted lines), a turnover frequency of 720 Hz is obtained with $R = 10\text{ k}$ and $C = 22\text{ n}$.

2

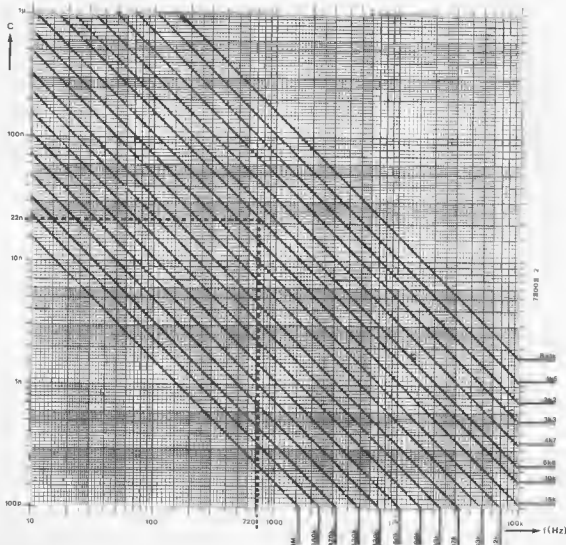

simple video sync generator 28

This simple circuit will generate 15625 Hz and 50 Hz line and field sync pulses for video applications. A clock signal from a 125 kHz astable multivibrator is divided down by a 4040 12-bit counter, the Q outputs of the counter being NANDed together to give line pulses with a duration of 4 μ s and field sync pulses with a duration of 512 μ s. Using the video mixer featured elsewhere in this issue the sync pulses may be combined with picture information to give a composite video signal, in which case both circuits should be operated from a 5 V supply.

The clock oscillator should be tuned to 125 kHz using a frequency counter, if available. Alternatively it may be adjusted to give a stable raster on a TV set.

(see circuit 74)

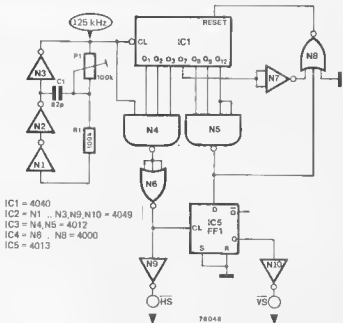

improved 723 supply 29

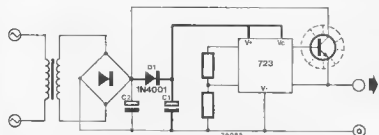

The 723 is a very widely used IC regulator. Hence the following circuit, which is intended to reduce power dissipation when the 723 is used with an external transistor, should prove very popular.

According to the manufacturer's specification the supply voltage to the 723 should always be at least 8.5 V to ensure satisfactory operation of the internal 7.5 V reference and of the IC's internal differential amplifier.

Using the 723 in a low-voltage high-current supply, with an external series transistor operating from the same supply rail as the 723, invariably results in excessive dissipation in the series transistor. For example, in a 5 V 2 A supply for TTL about 3.5 V would be dropped across the series transistor and 7 W would be dissipated in it at full load current. Furthermore, the

reservoir capacitor must be larger than necessary to prevent the supply to the 723 falling below 8.5 V in the ripple troughs.

In fact the supply voltage to the series transistor should be no more than 0.5 V above the regulated output voltage, to allow for its saturation voltage.

The solution is to use a separate 8.5 V supply for the 723 and a lower voltage supply for the external transistor. Rather than using separate transformer windings for the two supplies, the supply to the 723 is simply tapped off using a peak rectifier D1/C1. Since the 723 takes only a small current C1 will charge up to virtually the peak voltage from the bridge rectifier, 1.414 times the RMS voltage of the transformer minus the voltage drop of the bridge. The transformer voltage thus needs to be at least 7 V to give an 8.5 V

supply to the 723.

However, by suitable choice of reservoir capacitor C2 the ripple on the main unregulated supply can be made such that the voltage falls to about 0.5 V above the regulated output voltage in the ripple troughs. The average voltage fed to the series transistor will thus be less than 8.5 V and the dissipation will be greatly reduced.

The value of C1 is determined by the maximum base current that the 723 must supply to the series output transistor. As a rule of thumb allow about 10 μ F per mA. The base current can be found by dividing the maximum output current by the gain of the transistor. A suitable value for the main reservoir capacitor C2 is between 1500 and 2200 μ F per amp of output current.

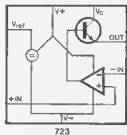

30 HF current gain tester

The high-frequency current gain of a transistor is dependent on the DC bias conditions under which it operates, maximum gain being obtained at only one particular value of collector current.

This simple circuit is designed to determine the optimum collector current for any NPN RF transistor. The transistor under test (TUT) is inserted into an amplifier stage which is fed with a constant amplitude 100 MHz signal from an oscillator built around T1. This signal is amplified by the TUT, rectified by D1 and filtered by R10 and C9 to give a DC signal proportional to the RF signal output from the TUT. This, in turn, is proportional to the gain of the TUT.

The collector current through the TUT can be varied between 1 mA and 10 mA by means of P1, which should be fitted with a scale marked

out linearly between these values. It is then a simple matter to adjust P1 until the maximum output voltage is

obtained on the meter, whereupon the optimum collector current can be read off from the scale of P1.

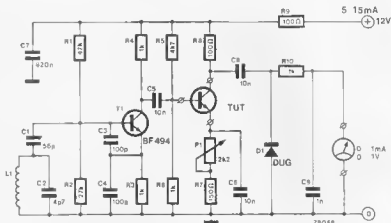

L1 = 5 Wdg. 0.8 mm Cu ϕ 6 mm
L1 = 5 turns 0.8 mm (21 SWG) Cu ϕ 6 mm

31 infra-red transmitter

This IR transmitter may be used with the receiver described elsewhere in this issue to make a simple infra-red control link. The IR signal is pulsed on and off at 24 kHz to enable the receiver to differentiate between it and extraneous 'DC' IR sources such as the sun and room lighting. To obtain a reasonable operating range the receiver must be sensitive and selective, and to avoid unreliability due to the transmitter frequency drifting outside the receiver passband the transmitter frequency must obviously be stable. To this end an LC oscillator circuit is employed, which is a transistor version of the Franklin oscillator commonly employed in valve circuits.

Due to the Q of the tuned circuit the voltage across L1 may exceed supply voltage. This could result in the collector-base junction of T1 being forward-biased, which would damp the tuned circuit. The inclusion of D1 prevents this occurrence.

The oscillator frequency may be varied between approximately 23.7 and 25.9 kHz using C3, which allows alignment of the transmitter and receiver. In view of the narrow bandwidth of the receiver and the limited tuning range available

it is essential that the component values given in the circuit should be adhered to (use 5% tolerance components).

Various types of infra-red LED may be used in the transmitter circuit, but the LD271 is most efficient and will give the greatest range. Whatever type of LED is used the performance of the circuit can be optimised by adjusting the value of

R3 so that the LED current is 100 mA. Two or more LEDs may also be connected in series, in which case the value of R3 must also be adjusted to give a LED current of 100 mA. If more than two LEDs are connected in series then the supply voltage must be increased by 1.5 V for each additional LED.

(see circuit 21)

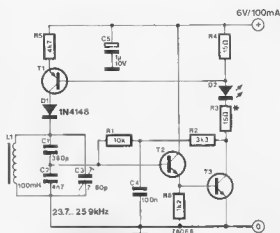

T1 = BC567B, BC177B
T2 = BF494, BF194
T3 = BC140, 2N2219
D2 = LD241, LD242, LD271.

analogue-digital converter 32

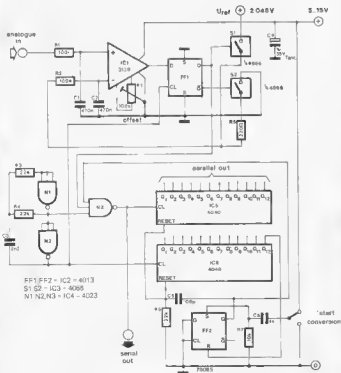
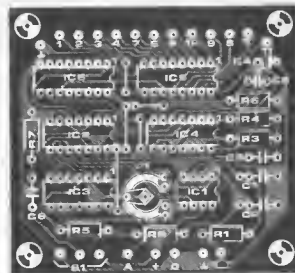
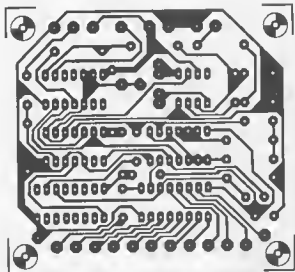

33 stereo width control

Although the idea is not new, this circuit for a stereo width control is distinguished by its simplicity.

A stereo width control is used to vary the width of a stereo sound image from *mono*, through *normal stereo*, to *extended* or *super-stereo*. Expansion of the stereo image width is obtained by means of negative crosstalk between the two channels, i.e. a portion of the L-signal appears in antiphase in the R-channel, and vice-versa. Positive crosstalk, where the 'crosstalk' signal portion and the channel into which it is blended are in phase with one another, results in a reduction of the stereo width.

How the circuit functions is quite simple. Two opamps and resistors R2, R2' and R4 provide 60% (-4.4 dB) negative crosstalk at the outputs of IC1/IC1', whilst R3, R3' and P1 provide variable positive crosstalk. With P1 set for maximum resistance, the negative crosstalk at the outputs amounts to approx. 50% (-6 dB). With P1 at the minimum setting (turned fully anti-clockwise), the L

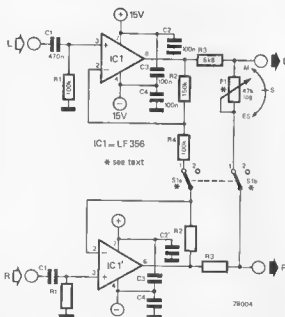

and R output signals are the same (mono), whilst with P1 in the mid-position the negative and positive crosstalk cancel each other out,

leaving normal stereo. Normal stereo can be obtained even more simply by incorporating a two-way switch, S1, in series with R4/P1.

34 hum filter using electronically simulated inductor

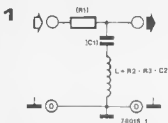

There are many cases where it is useful to be able to get rid of spurious mains (50 Hz) interference. The simplest way of doing this is to employ a special filter which rejects only the 50 Hz signal components whilst passing the other signal frequencies unaffected, i.e. a highly selective notch filter. A typical circuit for such a filter is given in figure 1.

Since a filter with a notch frequency of 50 Hz and a Q of 10 would require an inductance of almost 150 Henrys, the most obvious solution is to synthesise the required inductance electronically (see figure 2).

The two opamps, together with

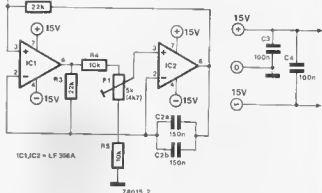

R2, R5, C2 and P1, provide an almost perfect simulation of a conventional wound inductor situated between pin 3 of IC1 and earth. The value of inductance thereby obtained is equal to the product of the values of R2, R3 and C2 (i.e. $L = R2 \times R3 \times C2$). For

tuning purposes this value can be varied slightly by means of P1. If the circuit is correctly adjusted, the attenuation of 50 Hz signals is 45 to 50 dB. The circuit can be used as it stands as a hum rejection filter in harmonic distortion meters or as a hum filter for TV sound signals.

back and front doorbell 35

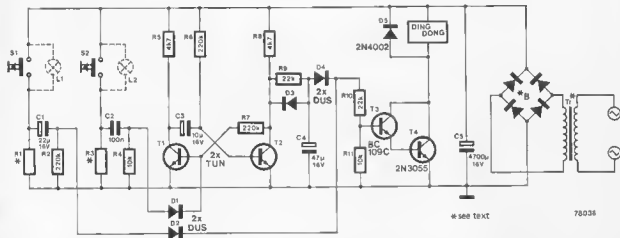

Some types of 'ding-dong' door chimes are designed to give different signals for back and front doors. However, the majority of doorbells are not, and this article describes a circuit that will allow an ordinary doorchime to produce two different signals, a ding-dong signal for the front door and a dong signal for the back door. A small gimmick is also incorporated to thwart impatient individuals who repeatedly press the bellpush. When the front door bellpush is pressed the ding-dong signal will sound once and is then inhibited for about five seconds. The dong signal, which is less strident, is allowed to sound a maximum of once every two

seconds. The circuit operates as follows: When the front bellpush (S1) is pressed C1 charges rapidly through D2, R10 and the base emitter junctions of T3 and T4. These transistors are turned on briefly, which causes the striker of the chime to move rapidly across and back, thus producing the ding-dong chime. However, the chime cannot sound again until C1 has discharged through R1 and R2, which takes several seconds after the bellpush is released. Repeated pressing of the button has no effect. When the back door button (S2) is pressed the monostable comprising T1 and T2 is triggered, T1 turns on and T2 turns off. C4 now charges

slowly via R8 and R9. T3 and T4 thus turn on slowly, pulling the striker across very slowly so that the 'ding' chime does not sound. When the monostable resets after about 1½ seconds C4 discharges quickly through D3 and T2. T3 and T4 turn off and the striker of the chime flies back rapidly, thus producing the 'dong' sound.

If illuminated bellpushes are used then R1 and R3 should be rated at between 10 and 33 ohm 2 W to suit the bellpush lamps. Otherwise any value between about 4k7 and 47 k is suitable.

The original bell transformer can be used. The bridge rectifier should be capable of handling at least 1 A.

voltage mirror

36

(H. Springer)

Previous issues of *Elektor* have already discussed a number of different ways of using a transformer with only one secondary winding to obtain both a positive and a negative supply voltage. This design is a further contribution to the discussion.

The circuit uses a second bridge rectifier (D1...D4) which, via C1 and C2, is capacitively-coupled to the transformer. Since the resultant voltage is DC-isolated from the transformer, to which the other rectifier (D5...D8) is connected, the positive terminal of C3 can be linked directly to the 0V rail to give a symmetrical \pm supply. Since (because of C1 and C2) C3 is charged from a higher impedance

than C4, this capacitor should have a higher value than C4, otherwise the internal impedance and ripple voltage of the negative supply will differ significantly from its positive counterpart.

The working voltages of the capacitors should at least equal the peak value of the transformer voltage. With the values given in the diagram the circuit will supply approx. 0.1 A for a transformer voltage of 15 V and a ripple voltage of 1 V. Naturally enough all the capacitance values can be increased by the same factor in order to reduce the ripple voltage. As far as the bridge rectifiers are concerned, these should be adequately rated to withstand the

peak transformer voltage and the maximum load current.

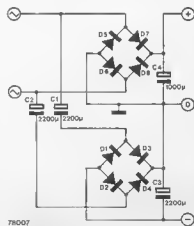

37

speedy rectifier

Precision rectifiers which use a diode in the feedback loop of an operational amplifier are well known. Such an arrangement virtually eliminates the forward voltage drop of the diode and allows even small signals to be accurately rectified. However, since the op-amp operates open loop up to the point where the diode becomes forward biased the maximum operating frequency of such rectifiers is limited by the slew rate of the op-amp used.

Precise rectification of small signals even at the higher audio frequencies requires an op-amp with quite a high slew rate and such op-amps are not inexpensive. Fortunately an alternative solution is to build a precision rectifier using inexpensive small-signal transistors.

In this circuit diodes D1 and D2 are current driven, so the output voltages developed across load resistors R10 and R11 are proportional to the current through the diodes and are independent of their forward voltage drops. The signal to be rectified is fed to T1, and current drive to the

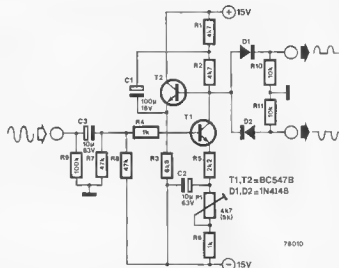

diodes is achieved by bootstrapping the emitter of T2 to the junction of R1 and R2. A positive half-wave rectified version of the input signal is available across R10 and a negative half-wave rectified signal at R11. When viewed on an oscilloscope there was no deviation from a true

half-wave rectified output at frequencies in excess of 400 kHz and input signal levels up to 2 V peak to peak (sine-wave input). The only setting up that the circuit requires is to adjust P1, with no input signal, until the collector voltage of T1 is exactly zero.

38

liquid level alarm

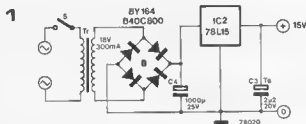

Various designs for liquid level indicators using discrete components have previously been published in *Elektor*. However, this design uses only a single integrated circuit, the LM 1830 from National Semiconductor. This IC can be used in a variety of alarm circuits with resistive transducers such as LDRs and thermistors or, as in this case, a liquid level probe.

When the electrodes of the probe are immersed in the liquid, which must, of course, be a conductor, an AC

signal generated by the IC flows through the liquid. Use of AC rather than DC means that electrolytic effects are minimised. When the liquid falls to such a level that the electrodes are no longer immersed, current no longer flows through the liquid. This is detected by a comparator in the IC, and an alarm signal is fed to the loudspeaker. The best material to use for the electrodes is stainless steel, since this is resistant to corrosion. The probe can easily be constructed

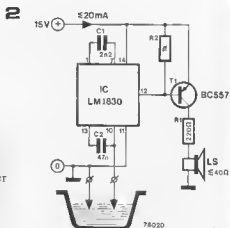

from a pair of stainless steel meat skewers, which are available from hardware shops.

(National Semiconductor Applications)

FET audio amplifier

39

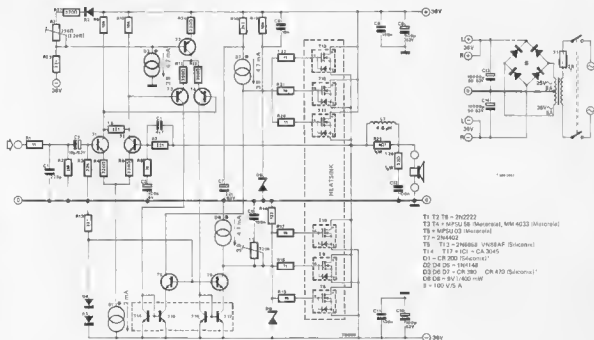

- T1 T2 T8 - 2N2222
- T3 T4 - MPSJ 58 (Motorola, MN 4033 (Motorola)
- T5 - MPSJ 03 (Motorola)
- T7 - 2N4602
- T9 - T13 - 2N6658 UNIFAET (Siliconix)
- T14 - T17 - 4C1 - CR 3045
- D1 - CR 300 (Siliconix)
- D2 D4 D5 - 1N4148
- D3 D6 D7 - CR 390 CR 470 (Siliconix)
- D8 D9 - 9V / 400 - W
- β = 100 1/5 A

Power FETs have been used in a number of Japanese audio amplifiers for some time now, and indeed were discussed in *Elektron* No. 14, June 1976, p. 628. Readers are referred to this article for a full discussion of the application of power FETs in audio amplifiers. Using power V-FETs manufactured by Siliconix it is now possible to present a FET audio amplifier design suitable for home construction, which is based on a Siliconix application note. The advantages offered by V-FETs in audio output stages are considerable. The 2N6658 used in this circuit has a cutoff frequency of 600 MHz, and yet is completely free from the secondary breakdown problems that bedevil high-frequency bipolar transistors. The current gain of a V-FET is virtually infinite, the transfer characteristic is extremely linear for drain currents greater than 400 mA and the temperature coefficient of drain current is negative, thus eliminating thermal runaway problems. The maximum drain source voltage of the 2N6658 is 90 V, which is more than adequate for audio amplifier applications. However, the maximum drain current is only 2 A and the maximum dissipation 25 W, so a number of V-FETs must be connected in parallel in the output stage of the amplifier (T8 to T13). The same type (polarity) of FET is

used in each half of the output stage, and the two halves of the output stage therefore require antiphase drive signals. This is easily achieved, as antiphase signals are available as far back in the circuit as the input stage, which consists of a long-tailed pair T1/T2. The antiphase signals from the collectors of the input stage drive a second long-tailed pair T3/T4, the antiphase outputs of which feed two driver stages, T5/T14/T15 and T6/T16/T17, each of which comprises a current mirror and cascode stage. Provision of DC biasing throughout the amplifier is simplified by the use of constant current (Norton) diodes. It should be noted that, although any type of Norton diode from CR390 to CR470 may be used for D3, D6 and D7, they must all be the same type. With the power supply shown, which is adequate for a stereo version of the amplifier, the circuit will deliver an output of 40 W per channel into 8 ohms with a harmonic distortion of 0.04% at 1 kHz. Clipping does not occur until 55 W into 8 ohms, but above 40 W the distortion will gradually increase. The slew rate of the amplifier is 100 V/μs, and the output is short-circuit proof. Finally, a few practical hints on constructing and setting up the circuit. The six output FETs should be mounted together on a single

heatsink with a thermal resistance of less than 2°C/W. The gate resistors R15 to R22 should be mounted as close as possible to the gate leads of the FETs. For setting up the amplifier, it should temporarily be connected to a stabilised power supply with the current limit set to between 500 mA and 1 A. Alternatively a 100 ohm 10 W resistor may temporarily be connected in series with the drain lead of T8 ... T10 and of T11 ... T13 to limit the current. Before applying power P1 and P2 should be set to maximum resistance and a milliammeter connected in the positive supply lead. When power is applied the current consumption should be about 40 mA. P2 should then be adjusted until the supply current shows a sharp increase, after which the amplifier should be left for about 5 minutes to warm up. The supply current may then be adjusted to between 200 and 350 mA using P2. Finally, P1 should be adjusted to give minimum distortion at an output power of 10 W into 8 ohms with a 1 kHz sine wave input. However, if equipment is not available to carry out this adjustment P1 may simply be set to its mid-position or adjusted by ear.

Literature.
Siliconix Application Note AN 76-3 and Design Aid DA 76-1.

40 power flasher

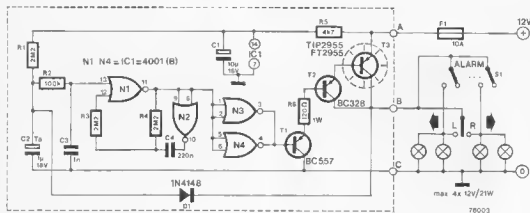

Despite the vast array of solid-state devices now available, the flasher units for car direction indicators are still almost exclusively electro-mechanical. Apart from the obvious objection of unreliability, these units suffer from the problem that the flashing rate is dependent on ambient temperature, battery voltage and load. This latter factor means that if one wishes to wire all four indicators to flash simultaneously as a hazard warning, it is necessary to use a separate flasher unit.

The electronic flasher discussed here suffers from none of these disadvantages. The repetition rate is practically independent of battery voltage, temperature and load, has a built-in hazard warning switch and is extremely reliable. Furthermore it

complies with all the legal requirements for turn indicators, the repetition rate of 40 to 90 flashes per minute being within the specified range and the circuit being arranged so that the indicators light immediately when the turn indicator switch is operated.

The circuit is basically an astable multivibrator constructed around two CMOS NOR gates N1 and N2, N3, N4, T1, T2 and T3 buffer the output of this astable to drive the indicator lamps.

When the indicator switch is operated C2 discharges rapidly through D1 and the indicator lamps. Pin 13 of N1 goes high and its output goes low. The outputs of N3 and N4 thus go high, turning on T1, T2 and T3 and lighting the indicators. The

astable then begins to oscillate at approximately 1 Hz, turning the indicator lamps on and off.

If the hazard warning switch, S1, is closed then the circuit operates in exactly the same fashion except that all four lamps are connected in parallel and flash in synchronism. T3, which switches most of the load current, must be mounted on a heat-sink. If a metal box is used to house the unit then T3 can be bolted to the wall of this using an insulating washer and bush. The current in the leads connected to points A and B is quite large (up to 8 A) so heavy-gauge wire must be used for these connections. The positive supply lead must be fitted with a 10 A fuse if not already fused.

Parts list.

Resistors:

R1, R3, R4 = 2M
R2 = 100 k
R5 = 4k7
R6 = 120 Ω (1 Watt)

Capacitors:

C1 = 10 µ/16 V
C2 = 1 µ/16 V (tantalum)
C3 = 1 n
C4 = 220 n

Semiconductors:

IC1 = 4001 (8)
T1 = BC 557, 8C 177
T2 = BC 328, 8C 327
T3 = FT 2955 (Fairchild) TIP 2955
D1 = 1N4148

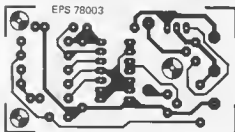
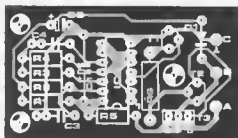

signal injector

41

This simple signal injector should find many uses in trouble shooting and alignment applications. It produces an output with a fundamental frequency of 100 kHz and harmonics extending up to 200 MHz and has an output impedance of 50 ohms. N1, N2 and N3 form an astable multivibrator with a virtually symmetrical squarewave output and a frequency of approximately 100 kHz. The output of the oscillator is buffered by a fourth NAND gate N4. Since the squarewave is symmetrical it contains only odd harmonics of the fundamental frequency, the higher harmonics being fairly weak due to the relatively slow rise time of the CMOS devices employed. As it is necessary for the higher harmonics to be at a reasonable level if the circuit is to prove useful at high frequencies, the output of N4 is fed to a differentiating network R2/C2. This attenuates the fundamental relative

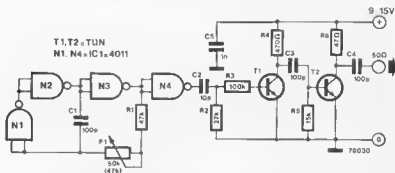

to the harmonics, producing a needle-pulse waveform which is then amplified by T1 and T2. This is rich in harmonics and, due to the extremely small duty-cycle of the waveform, the power consumed by the output stage, T2, is fairly small. The output frequency of the signal injector can be adjusted by means of P1. If an accurate output frequency is required then the signal injector can be adjusted by beating its second

harmonic with the 200 kHz Droitwich broadcast transmitter. The frequency stability of the circuit is largely determined by the construction. To minimise hand capacitance effects the unit should be housed in a metal box for screening, with the only output connection being the signal probe. If desired, a 1 k preset may be included in series with P1 to allow easier fine tuning.

flasher bleeper

42

Although extremely useful, the self-cancelling devices fitted to car direction indicators are not infallible. For example, they will not operate when only a small movement of the steering wheel is made, as when pulling out to overtake. An audible warning device to indicate that the flashers have not cancelled is preferable to the visual indication normally fitted, as it is more noticeable and does not require the driver to take his eyes off the road. The circuit consists simply of a 555 timer connected as a 1 kHz astable multivibrator. The output of the 555 is more than sufficient to drive a small loudspeaker. When the trafficator switch (S) is set to either the left or right positions, power is supplied to the multivibrator via the flasher unit and D1 or D2. The circuit thus 'beeps' with the same rhythm as the flashing of the indicators. If desired, the volume can be reduced by increasing the value of R3. The 'beep'

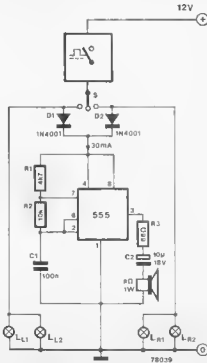

frequency is determined by C1. For operation in positive earth cars D1 and D2 should be reversed and the multivibrator circuit turned upside-down, i.e. the C1/pin 1/loudspeaker junction is connected to the commoned anodes of the diodes and the R1/pin 4/pin 8 junction is connected to supply common.

43 car battery monitor

In the winter months, when starting a difficult and headlamp start frequently be used, it is all too easy for a car battery to be discharged to a dangerously low level, especially if so long journeys are undertaken. Here, the IC type TCA965, which provides continuous monitoring of the state of the battery, should prove extremely useful. The unit will indicate if the battery is discharged or is overcharged.

The circuit is based on the famous IC type TCA965. This IC is a window comparator which will indicate whether the input voltage lies between two preset reference voltages or below the low reference voltage or above the high reference voltage. That three conditions are indicated by three LEDs which are driven directly by the IC. The IC also has a reference voltage output which can be used to derive the upper and lower thresholds of the 'window'.

The circuit is powered from the 12 V car battery, and the battery voltage is also fed, via potentiometer R1/R2 to the monitoring input of the IC. The reference voltage output is fed

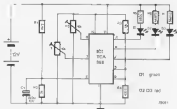

to the two threshold inputs via potentiometers P1 and P2, which are used to calibrate the system.

The lowest acceptable voltage for a 12 V car battery is about 11.5 V, and P1 is adjusted so that D1 lights when the input falls below the voltage. If the battery voltage ever shows 14.5 V it is overcharged, which indicates that the car voltage regulator is at fault. P2 is therefore adjusted so that D3 is lit for input voltages above 14.5 V. Between

11.5 V and 14.5 V the green LED should light, indicating that the condition of the battery is satisfactory.

It will be noted that the LEDs do not glow and remain lit at exactly the same voltage. This is due to a hysteresis of 60 mV which is incorporated into the IC to prevent the LEDs flickering when the battery voltage is close to the threshold levels.

Simple Application Note

44 ultrasonic alarm transmitter

Most ultrasonic transducers can be operated at most levels up to 50-80 V peak-to-peak. This usually means employing an ultrasonic oscillator followed by an amplifier (with a 50-80 V supply) to drive the transducer. Provision of this amplifier and its high voltage supply (usually suspended as the system, since other parts of the alarm system will probably be operated from a lower voltage) is a 12-15 V. The alternative is to operate the transducer at the same low voltage level with a consequent reduction in range. The oscillator circuit described here uses only a single transistor, operates from a 12-15 V supply, yet provides a 60 V p.p. signal to drive the transducer. The secret lies in basically a Parrot oscillator (see

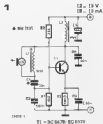
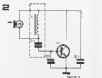

Figure 2) The transmitter is connected at one end to the frequency determining inductor L1 and the



voltage developed across it, with the low inductance due to the Q of the circuit system. The resonant frequency of the oscillator is 35 kHz, but may be varied by altering the values of L1 and C1. However, the inductor L1/C1 must always remain within 10% of the value used as the original circuit (1 μ H/27 pF).

ultrasonic alarm receiver

45

This ultrasonic receiver can be used with the transmitter described elsewhere in this issue to construct an alarm system operating on the Doppler principle. Ultrasonic signals sent out by the transmitter are reflected from objects in the area under surveillance and are picked up by the receiver. Reflections from any moving object such as an intruder will exhibit a slight shift in frequency due to the Doppler effect. Mixing of the Doppler shifted signals with the normal reflections causes cyclic variations in the amplitude of the received signal at a low frequency, dependent on the speed of the moving object. These variations are detected by the receiver circuit and used to trigger the alarm. The receiver utilises the reflex principle. Ultrasonic signals picked up by the receiver transducer are

amplified by T1 and T2. A tuned circuit L1/C1, connected across the transducer, improves selectivity. Due to a lowpass filter R9/C7, the amplified U/S signal cannot reach the base of the low-frequency amplifier stage, T4. Instead it passes through C5 to be rectified by an 'infinite impedance' detector stage built around FET T3. A lowpass filter comprising R7 and C2 removes the high frequency component of the signal, whilst C3 acts as a DC blocking capacitor. The signal which appears across C2 is thus the low-frequency envelope of the received ultrasonic signal, which of course results from variations in the received signal amplitude due to Doppler shift. The LF signal passes through L1, which is virtually a short circuit at low frequencies and passes through T1 and T2. These transistors

are thus used to amplify both U/S and LF signals, as in a reflex radio receiver.

After amplification the LF signal passes through the lowpass filter R9/C7 to the output stage T4/T5. Depending on the setting of P2 this stage can operate as a Schmitt trigger or a linear amplifier. In the trigger mode T5 is normally turned on so that the output is high. When a signal arrives at the base of T4 the output will go low. In the linear mode the LF signal can be made audible by a pair of headphones or a small loudspeaker connected to the output. To set up the receiver P2 is adjusted (with no U/S input Signal) until the output goes high. The transmitter is then switched on and P1 is adjusted to give the required sensitivity.

(see circuits 44 and 47)

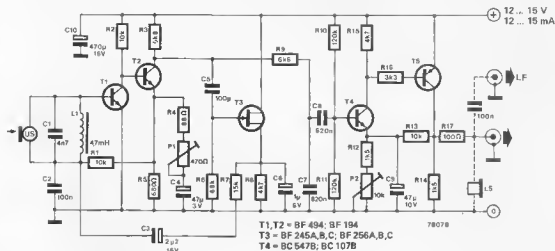

debouncer

46

Various microprocessor circuits place particular requirements upon the duration of certain control signals. If these signals are generated by manually operating a switch or key (e.g. reset and interrupt keys), then the conventional debounce circuit consisting of an RS flip-flop is not always foolproof, since there is always the chance that the key will be released prematurely. The accompanying circuit however,

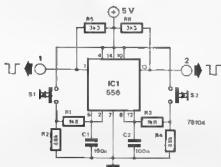

ensures that the signal level is maintained for a certain time after the key has been released. The exact length of time is determined by the values of R1, R2 and C1 for switch S1, and by R3, R4 and C2 for switch S2. If S1 is depressed, then output 1 goes low, whilst depressing S2 will likewise take output 2 low. Since the 556 has open collector outputs, it can easily be connected in a wired-OR configuration.

47 ultrasonic alarm indicator

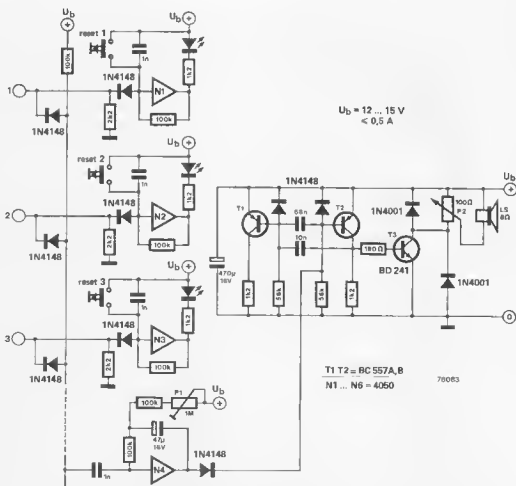

This circuit can be used to link one or more ultrasonic receivers (see circuits 44 and 45) to a central alarm system. It can also be used in conjunction with the infra-red alarm described elsewhere in this issue. The circuit provides both audible and visual (LED) indication that the alarm has been triggered.

The indicator consists of a number (in the circuit shown there are three) of flip-flops, each of which is connected to the output of a receiver. The flip-flops are derived from the 'super-simple touch

switch' which is also described elsewhere in this issue. The flip-flop is triggered by a logic '0' appearing at its input (the output of the receiver of course goes low when the alarm is activated). The corresponding LED then lights up and remains on until the flip-flop is returned to its original state by pressing the reset button.

One or more of the inputs going low also has the effect of triggering the monostable round N4. It in turn drives the squarewave generator round T1 and T2. The resulting

squarewave signal is fed via an output stage, T3, to the loudspeaker. By means of P1 the duration of the alarm signal can be varied from one or two to several tens of seconds; volume control is provided by P2. The number of inputs can be increased indefinitely by simply repeating the circuit around the input flip-flop the desired number of times. Using one 4050 an indicator circuit for five alarm installations can be built.

48 selective bandpass filter

There are a number of applications, such as the analyser filters in a real-time audio spectrum analyser, which require bandpass filters that are

highly selective and yet have a virtually flat response within the passband. Simple selective (resonant) filters fail to meet these requirements

because selectivity requires a high Q (quality factor) whereas a flat response within the passband requires a low Q. These conflicting

1

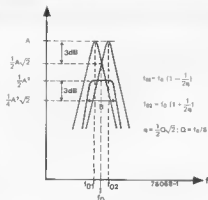

2

$$R_1 = R_6 = R_7 = R_8 = 100 \text{ k}\Omega$$

$$C_1 = C_2 = \frac{10}{f_0} \text{ (nF, kHz)}$$

$$C_3 = C_4 = \frac{10}{f_0} \text{ (nF, kHz)}$$

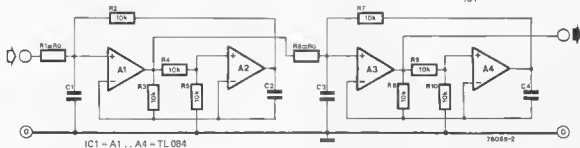
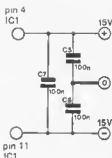

requirements cannot be satisfied by a single filter.

A solution is to connect in cascade two selective filters with staggered centre frequencies. Each filter has the same gain (A) at the centre frequency and quality factor Q , but the centre frequencies are different

(f_{01} and f_{02}). The centre frequency of the cascaded combination is f_0 , the frequency at which the two response curves intersect. By ensuring that the gains of the individual filters are $\frac{1}{2}A\sqrt{2}$ at this intersection, the combined gain at f_0 is A and the response is maximally flat within the

passband.

A practical circuit for such a filter arrangement is shown in figure 2. Given the desired centre frequency f_0 and either the required Q or bandwidth B , the component values R_1, R_6 and C_1 to C_4 can be calculated using the equations given.

Stable-Start-Stop-Squarewave

49

In digital circuits where parallel information must be converted into serial data, a start-stop oscillator is often used. One system is to use the oscillator to clock a counter, the output of which is compared with the parallel data. Initially the counter is reset; the external oscillator is then started, clocking the counter; when the correct count is reached, the oscillator is stopped. The result is a

(clock) pulse train, the length of which corresponds to the binary number given by the parallel data. It is not sufficient for these applications to gate the output of a free-running oscillator, since the 'enable' signal is not normally synchronised to the oscillator. The circuit described here is actually turned on and off by the enable signal, and it has proved reliable and

stable for output frequencies up to 10 MHz.

As long as the enable input (one input of N3) is at logic 0, the oscillator is blocked and the output of N4 is also held at logic 0. When the enable input becomes logic 1, the oscillator starts immediately and the first output pulse is delayed only by the propagation times of N3 and N4.

1

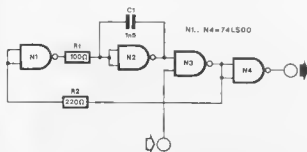

logic 1 = START
logic 0 = STOP 78103 1

2

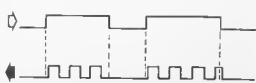

78103 2

50 bicycle speedometer

1

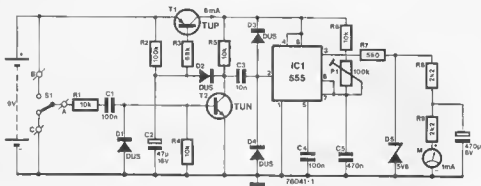

The novel feature of this bicycle speedometer is that it switches itself on when the bicycle starts to move and switches off when the bicycle stops, thus prolonging battery life without the need for a manual on/off switch.

Speed sensing is carried out by a reed switch attached to the bicycle frame, which is actuated by a magnet and magnets fixed to the wheel spokes. Electronics purists who scoff at 'unreliable' electromechanical switches need have no fears for the long-term serviceability of this arrangement. The life of a reed switch is typically 10^8 operations. Even with a small (10 inch) wheel bicycle this gives a life of

$10^8 \times 10 \times \pi$ inches or 49,583 miles!

The circuit operates as follows: When the bicycle is stationary T2 is turned off, C2 is charged to +9 V via R2, so T1 is turned off and no power is supplied to the circuit. As the bicycle starts to move the changeover reed switch S1 switches between positions B and C, thus turning T2 on and off. Since the reed switch is AC coupled to T2 no current is drawn when the bicycle is at rest, even if the reed switch should be activated by the magnet in this condition. When T2 is turned on C2 discharges rapidly through D2, turning on T1 and supplying power to the circuit. After the bicycle stops it takes several seconds for C2 to recharge sufficiently for T1 to turn off.

T2 also triggers IC1, which is connected as a monostable multivibrator. The output pulse width is fixed, so as the speed, and hence the triggering frequency, increases, the duty-cycle of the output waveform becomes greater.

The average output voltage, which is measured by the meter, thus increases in proportion to the speed.

2

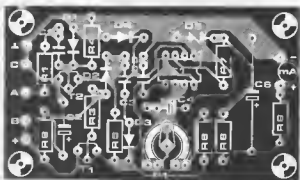
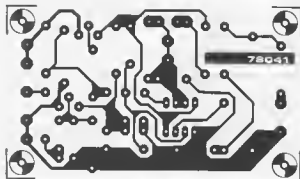
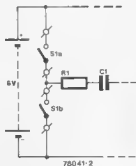

To calibrate the circuit a small calculation is necessary. The input frequency for a given speed is obtained from the equation:

$$f = \frac{(n) (s) 528}{(30\pi) D}$$

where 'n' is the number of magnets used, 's' is the speed in miles per hour and 'D' is the wheel diameter. The input frequency for a given speed can thus be calculated, and the speedometer can be calibrated by feeding in this frequency from an audio oscillator and adjusting P) until the correct speed reading is obtained.

As an example, suppose a bicycle with a 10 inch wheel is being used, and the meter is to be calibrated to a maximum speed of 50 m.p.h.

Assuming one magnet is used then the frequency for 50 m.p.h. is

$$\frac{1 \times 50 \times 528}{30 \times 3.142 \times 10} = 28$$

i.e. 28 Hz.

An alternative is to feed in a 50 Hz signal from the low voltage secondary of a mains transformer (6 - 12 V). The equivalent speed can be calculated by re-arranging the previous equation.

$$s = \frac{30 \times \pi \times D \times f}{528 \times n}$$

However, in the previous example 50 Hz would correspond to a speed of about 89 m.p.h. so if 50 Hz is to be used as a calibration frequency, two magnets should be

used on the wheel to bring the equivalent speed down to a more reasonable 44.5 m.p.h. For a 20 inch wheel the situation is worse as this wheel turns at half the rate of a 10 inch wheel for a given speed, so four magnets would be required. Since SPDT reed switches are somewhat rare, figure 2 shows how to connect two single pole reed switches and their placement on the wheel so they will function like S1 in figure 1.

saw-song 51

As with almost all self-driving 'melody generators', this circuit consists of a current-controlled oscillator and a control system. One possible approach would be to use a PLL (phase locked loop). A variant of the PLL concept is the sample-and-hold PLL, that has the advantage of being frequency sensitive to a sawtooth voltage. The 'saw-song' is therefore a sample-and-hold PLL that is prevented, by a deliberate wrong-polarity connection of the oscillator signal, from acquiring lock.

Figure 1 gives the block diagram and figure 2 the complete circuit diagram. The current-controlled oscillator consists of current-mirror T1 + T2 and unijunction transistor T3. This multivibrator generates a sawtooth waveform that is buffered by T4. T5 + T7 form a well-known sample-and-hold

circuit, for which the sampling pulses are generated by another unijunction transistor T8 and passed via T6 to the gate of T5.

When the circuit is operated with switch S1 open and S2 closed, it will produce a signal resembling the

sound of a singing saw. With S2 open and S1 closed the sound is somewhat 'jumper'. With both switches closed the circuit will produce a parakeet-like squawking noise. Potentiometer P1 can be used to vary the tempo of the 'melody patterns'.

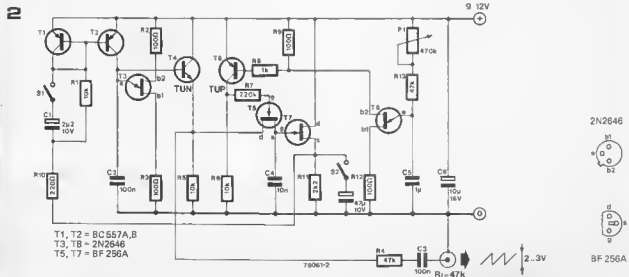

52 | preconsonant

As explained in greater detail in the Consonant article, the design aim for both units was to achieve superior performance in a true home-construction project. For this reason, readily available transistors have been used throughout. It may not seem 'up-to-date' if a circuit doesn't contain at least one IC, but the fact is simply that integrated circuits are either not good enough or else not readily available to the home constructor. A 741, for instance, makes for a notoriously sub-standard audio design, whereas a TDA 1034N (which does offer good performance) is anything but readily available — in fact, it is doubtful whether many of our readers had even heard of it before reading this issue! On the other hand, the BC 109C and its relatives (BC 249C, BC 549C etc., see the TUP/TUN list elsewhere in this issue) is available all over Europe — and, for those of our American and Canadian readers who have remarked that a code number like BC 109 reminds them of a jet aircraft, almost any high-quality low-noise Silicon transistor will perform equally well in these circuits.

The circuit

To some of our readers, the circuit (figure 1) may seem vaguely familiar: it is derived from the popular Preco design. With good reason: over the years it has proved its reliability, and everyone who has measured its performance has been astounded. Four transistors per channel may seem excessive, but time and theory can prove that two transistors are not really sufficient; three transistors are possible; but four transistors make for a reliable circuit — and the choice makes very little difference in the total cost of the project.

The input impedance is determined by R1, R3 and the input impedance of T1. With the values shown, it is very close to the required 47 k. The signal-to-noise ratio of the preamp is mainly determined by T1. A high S/N ratio can be obtained by choosing a good transistor, setting the collector current and the collector-emitter voltage correctly, and selecting the optimum emitter impedance. The base impedance is also important, but for a disc preamp there is very little leeway here since this

The Consonant, described elsewhere in this issue, is a high-quality audio control amplifier. Its main features are: extremely good performance, use of readily available components and ease of construction. The Preconsonant described in this article is a matching disc preamp. It can be mounted on the Consonant p.c. board, it too uses readily available components, and its performance is exceptionally good. Although the printed circuit board is designed to match the Consonant board, the disc preamp is a self-contained unit that can be used in conjunction with any high-quality control amplifier.

Specifications:

maximum deviation from IEC (RIAA) frequency response curve	± 1 dB
input overload level @ 1 kHz:	> 200 mV (RMS)
input headroom:	> 32 dB*
signal-to-noise ratio:	> 72 dB*
dynamic range:	> 100 dB
distortion at +14 dB input level	approx. 0.01%

* input headroom, signal-to-noise ratio and reference level for distortion measurement are referred to 0 dB = 5 mV (RMS) input level at 1 kHz; see text.

impedance is determined by the required input impedance (47 k) and the impedance of the phono cartridge.

For the type of transistor specified (and for most other low-noise, silicon PNP transistors) the fixed base impedance corresponds to minimum noise at a collector current of approximately 100 μ A. T1 drives a simulated super-NPN transistor, consisting of T2 and T3. The collector impedance of the 'super-transistor' consists of a current source, T4. This particular configuration combines several attractive features: high gain, good supply ripple rejection (as will be explained later) and high current drive capability. The latter feature is important because this stage must also drive the feedback network (R11, C5...C7), and since the feedback network must be tailored to provide the desired IEC correction* its impedance drops sharply with increasing frequency.

Theoretically, the IEC frequency response curve corresponds to three time constants: 3180 μ s (50 Hz, pole), 318 μ s (500 Hz, zero) and 75 μ s (2120 Hz, pole). In practice, in a combined circuit like this, mutual interaction of the various RC networks calls for slightly different time constants. R11, C5, C6 and C7 provide the two higher time constants; the lower is determined in part by R6, R7, R8 and C4. Back now, briefly, to T4. Basically a current source consists of one transistor and three resistors T4, R13, R14 and R15. However, including C9 ensures that the base voltage of T4 is identical to the voltage at the lower end of R15, for all but the very lowest frequencies (and DC). This ensures that the AC collector current is virtually zero,

* In Europe, the frequency characteristic of disc preamps must conform to the IEC norm. The (old) RIAA norm specified in the USA basically specifies the same characteristic in a different way: the new RIAA norm is virtually identical to the combined Preconsonant/Consonant characteristic since it specifies an additional low-frequency roll-off similar to that incorporated in the Consonant.

providing a very high AC impedance for T2/T3 and simultaneously leading to a very high supply ripple rejection. Remember the 'One-TUN gyrator'?

The printed circuit board

The complete stereo disc preamp can be mounted on the p.c. board shown in figure 2. As stated earlier, this board was designed for mounting on the Consonant board: the six solder pads along one side of the board correspond to six pads on the Consonant board, so the two boards can be joined by means of six short wire links.

There are four true electrical connections (left and right preamp outputs, supply common and positive supply); the remaining two connections are included for mechanical rigidity. The positive supply voltage (21 V) is derived from the Consonant supply. If the Preconsonant is to be used in combination with a different control amplifier, a suitable supply (20...24 V, 10 mA) will have to be derived from this.

The only other connections to the Preconsonant are the left and right inputs; these are connected by means of short lengths of screened cable to the disc preamp input. These connections are illustrated in greater detail in the Consonant article (figure 10).

Preset potentiometer P1 is included in case the output of the Preconsonant is too high. The 'Tuner' and 'Auxiliary' inputs of the Consonant are also fitted with input level presets, so that it is always possible to reduce the level of the two loudest signal sources to that of the third. In this way, annoying level jumps when switching from one signal source to the next can be avoided. If the Preconsonant is used in conjunction with some other control amplifier, P1 can usually be set at maximum.

Performance

The main specifications are given in a separate table. The frequency response and distortion specifications are also illustrated in the graphs shown in figures 3 and 4.

Figure 3 is the frequency response as plotted on a Brüel & Kjaer recorder. The

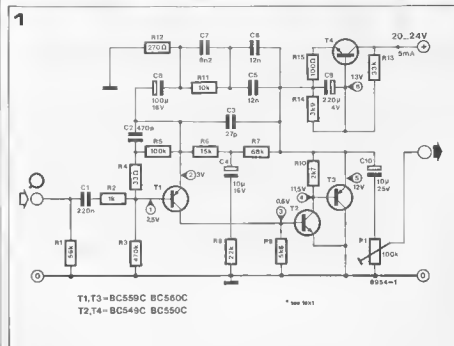
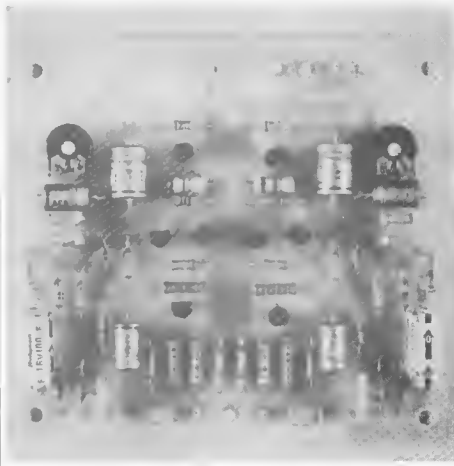
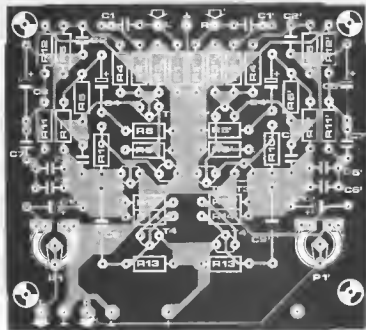
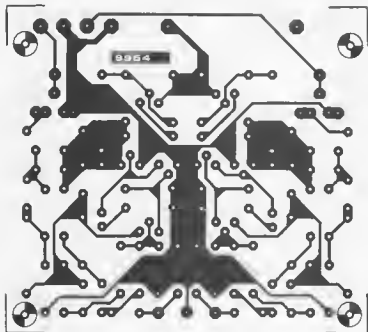

Figure 1. Complete circuit for one channel of the Preconsonant.

required levels in dB (with respect to 0 dB at 1 kHz) are listed below the frequency scale. The deviation from the required response is also plotted, along the 0 dB line of the (relative) dB scale. As can be seen, the prototype gave the required response curve with a deviation of considerably less than ± 0.5 dB over the complete 20 Hz...20 kHz frequency range. However, owing to the 5% tolerance in the frequency-determining components, a deviation of up to ± 1 dB can theoretically occur ('worst case').



Parts list.

Resistors:

- R1,R1' = 56 k
 R2,R2' = 1 k
 R3,R3' = 470 k (preferably low-noise)
 R4,R4' = 33 Ω
 R5,R5' = 100 k (preferably low-noise)
 R6,R6' = 15 k (preferably low-noise)
 R7,R7' = 68 k
 R8,R8' = 22 k
 R9,R9' = 5k6 (preferably low-noise)
 R10,R10' = 2k7
 R11,R11' = 10 k
 R12,R12' = 270 Ω
 R13,R13' = 33 k
 R14,R14' = 3k9
 R15,R15' = 100 Ω
 P1,P1' = 100 k preset potentiometer

Capacitors:

- C1,C1' = 220 n
 C2,C2' = 470 p
 C3,C3' = 27 p
 C4,C4' = 10 μ /16 V
 C5,C5' = 12 n
 C6,C6' = 12 n
 C7,C7' = 8n2
 C8,C8' = 100 μ /16 V
 C9,C9' = 220 μ /4 V
 C10,C10' = 10 μ /25 V

Semiconductors:

- T1,T1',T3,T3' = BC 179C,
 BC 559C, BC 560C, etc.
 T2,T2',T4,T4' = BC 109C,
 BC 549C, BC 550C, etc.

Figure 4 shows the result of a difference-frequency distortion measurement at an input level of +15 dB (30 mV at 1 kHz), using an 'anti-RIAA network' to maintain this level over the entire frequency range. A difference-frequency distortion measurement uses two equal-amplitude sinewaves, f_1 and f_2 , with a constant frequency difference $f_2 - f_1$ as the two signals are swept through the audio band. This arrangement has the advantage that measuring the difference frequency component at the output of a (pre-)amplifier under test gives information, not only concerning the (steady-state) Total Harmonic Distortion, but also on several other ' nasties ' which a 'normal' distortion measurement would

miss. However, the Preconsonant stood up well to this test: the average measured distortion was around 0.01%, with the highest peaks still well below the 0.03% level. Note that this measurement was performed at the highest input level likely to be encountered! This point may require some further clarification. Throughout this article, 0 dB has been consistently taken as corresponding to 5 mV (RMS) at 1 kHz. This value is derived as follows. On modern records, 0 dB level (corresponding roughly to the average level in loud passages) is typically about 4 cm/s peak velocity at 1 kHz. Modern hifi cartridges, by and large, deliver approximately 0.5 ... 2 mV (RMS) per cm/s tip peak

Figure 2. Printed circuit board and component layout for the stereo disc preamp (EPS 9954). The board is designed for easy mounting on the Consonant p.c. board.

Figure 3. Frequency response and deviation from the required response as measured for the prototype.

Figure 4. Result of a difference-frequency distortion measurement at an input level of +15 dB (30 mV at 1 kHz).

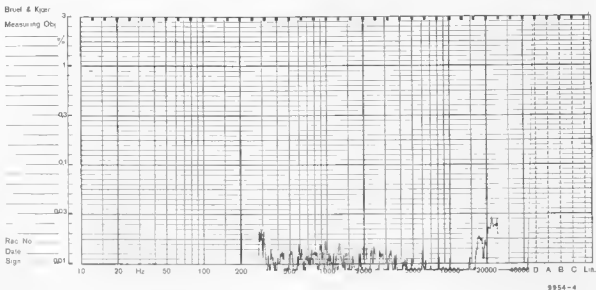
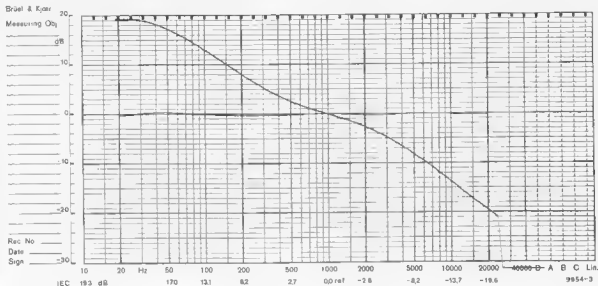

velocity. This means that 0 dB on the record may correspond to 2...8 mV at the input of the disc preamp, at 1 kHz. 5 mV is reasonable intermediate value. However, this is not the full story. On modern records, instantaneous signal peaks of up to +14 dB may occur, and for this reason the distortion measurement was carried out at approximately this level. For complete comfort, the preamp should be able to handle a +14 dB instantaneous peak with the most sensitive of modern cartridges – corresponding to some 60 mV (RMS) at 1 kHz. The input overload level of the Preconsonant is well over 200 mV, providing a safety margin of a good 10 dB above even this extreme level –

adequate insurance for technological improvements for some time to come! On the other hand, to be completely safe the signal-to-noise ratio should be at least 6 dB better than that of a modern record, even with the least sensitive cartridge (approximately 700 μ V per cm/s peak velocity). 0 dB in this case corresponds to 2.8 mV (RMS), or about 6 dB less than the value assumed so far. Since the Preconsonant has a signal-to-noise ratio better than 72 dB with respect to the 5 mV reference level, the S/N ratio even with the least sensitive cartridge will be over 60 dB. Manufacturers estimate that the best S/N ratio possible with a first-rate LP pressing is about 56 dB (with respect to

0 dB = 4 cm/s), so even in this extreme case (with the least sensitive cartridge) the Preconsonant is still a good 10 dB better. Good enough! M



PRECONSONANT * CONSONANT * CONSONANT

The Consonant is a high-quality audio control amplifier designed to complement the best modern power amplifiers. It offers such refinements as scratch and rumble filters, tone controls with cancel facility and switchable turnover frequencies, and provision for a built-in LED signal level meter. All components, including potentiometers and switches, are mounted on a single p.c. board, thus greatly simplifying wiring. A compatible disc preamp, which may be mounted separately or fixed to the back of the main board, is described in a separate article ('Preconsonant').

Specifications (see also text)

frequency response	20 Hz . . . 50 kHz (+0 dB, -3 dB)
input sensitivity	147 mV RMS for 440 mV RMS out
gain	x 3 (9.5 dB)
max. output voltage	3.5 V RMS (10 V p.p.l)
nominal output voltage	440 mV RMS
signal-to-noise ratio	> 72 dB for 440 mV RMS out
overload margin	> 15 dB above 440 mV RMS out
total harmonic distortion	approx. 0.04% (for 440 mV out)
channel separation	> 50 dB (at 1 kHz)
dynamic range	> 90 dB
output noise level	approx. 0.1 mV RMS
tone control characteristics:	
bass: turnover point 150 Hz	± 8 dB (at 50 Hz)
turnover point 300 Hz	± 10 dB (at 50 Hz)
treble: turnover point 2 kHz	± 12 dB (at 10 kHz)
turnover point 4 kHz	± 8 dB (at 10 kHz)
filters:	
rumble filter: turnover frequency	60 Hz (-3 dB), 12 dB/octave
scratch filter: turnover frequency	10 kHz (-3 dB), 12 dB/octave
balance control range	+2 dB, -7 dB
current consumption	approx. 30 mA (including LEO 02)
(without disc preamp and PPM)	

The principal considerations which governed the design of the Consonant were that:

1. The performance and facilities offered should be comparable with those provided by the best commercial designs.
2. The circuit should be simple to construct and should use readily-available components.
3. The controls should be laid out in a clear and logical fashion for ease of operation.

Block diagram

Figure 1 shows a block diagram of one channel of the Consonant, the layout of which follows conventional practice for a control amplifier of this type.

Any one of three signal sources, disc, tuner or auxiliary, may be selected by the input switch, and the input sensitivities may be adjusted by means of a preset on each input (except disc). Immediately after the input selector comes the rumble filter. This is placed before the tape monitor switch and can

53



SONANT * CONSONANT * CONSONANT

thus be switched in when recording from disc onto tape. There would be little point in putting the rumble filter after the tape monitor switch, for the simple reason that tape recorders do not suffer from rumble. Any rumble present on a disc that is to be recorded should be filtered out before the signal is fed to the tape deck.

At the output of the rumble filter the signal from the source is available for feeding out to the tape recorder and the tape monitor switch allows either this signal, or the signal fed back from the tape recorder, to be routed through the control amplifier. This is extremely useful if the tape recorder is a three-head machine, as the signal being monitored is the actual signal that has been recorded on a tape. If the recorder is a two-head machine then it merely feeds back the original signal.

The scratch filter is placed after the tape monitor switch since the facility to suppress high-frequency tape noise is just as useful as the facility for suppressing record surface noise. In addition, since many cassette recorders have a fairly limited h.f. response to begin with, switching in the scratch filter in the record path could result in an extreme lack of treble while leaving the tape noise unaffected. If a noisy record is to be transcribed onto tape it is much better to switch in the scratch filter during playback, thus attenuating the recorded disc noise and the tape noise.

Baxandall-type bass and treble controls are incorporated into the output stages of the control amplifier, and a stereo

image width control is also provided which can vary the image width from mono through stereo to 'super stereo'. Both the tone controls and image width control are provided with cancel switches. Finally, at the output of the control amplifier is the channel balance control. Of course, since the sensitivity of each input can be individually adjusted, the balance control will rarely be used once the system is set up, except to compensate for unbalanced programme material.

Complete circuit

The complete circuit of one channel of the Consonant is given in figure 2 and observant readers will notice that the tone control section bears a marked similarity to that of the highly successful Preco preamp, which was published in *Elektor* Nos. 12 and 13. However, the input section of the Consonant is considerably more complex than the Preco because of the rumble filter, scratch filter and the tape monitor facility, which the Preco lacked.

The input signals, with the exception of the signal from the disc preamp, arrive first at presets P1 and P2, which are used to set the input sensitivity for tuner and auxiliary inputs. The desired signal is then routed to the first stage of the Consonant via input selector switch S1. T1 is connected as an emitter follower and acts as a buffer between the signal sources and the rest of the circuit. This arrangement is superior to feeding signals direct to the tape monitor

switch, as is the case with some amplifiers, since the change in load impedance when the monitor switch is operated can cause variations in signal level if the signal source is unbuffered.

The rumble filter is also constructed around T1. It has a slope of 12 dB/octave and a turnover frequency (-3 dB point) of 60 Hz. As is evident from the circuit diagram and figure 4, the rumble filter is not switched completely out of circuit even when the filter switch is in the 'off' position — the turnover frequency is simply moved down to 20 Hz. This ensures that subsonic frequencies caused by record warps, or lowering of the pickup onto a record, are severely attenuated. This is a desirable feature since these low frequencies, although inaudible, can damage the bass units of loudspeakers. The output of the rumble filter is fed via the tape monitor switch to the gain control P4. The signal from the gain control is buffered by a second emitter follower, T2, around which the scratch filter is built. The slope of the scratch filter is 12 dB/octave, and the turnover frequency is 10 kHz. Like the rumble filter, the scratch filter is never switched completely out of circuit, but the turnover point is shifted up to 50 kHz with S5 in the 'off' position. This prevents the Consonant from operating as a long-wave radio receiver, which can happen in preamps whose frequency response is not restricted in this way. The slew-rate of signals with fast rise times is also limited, which helps prevent the power amplifier from running into transient intermodulation

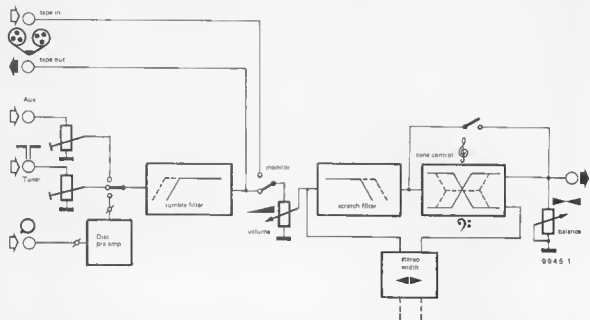

distortion (TIM). Of course, an upper frequency limit of 50 kHz is more than adequate for high-fidelity reproduction.

The tone control circuit is very similar to that employed in the Preco, the principal differences being the cancel switch S8, which shorts out the frequency-selective networks around P5 and P6, and the turnover point selection switches S6 and S7, which allow additional capacitors, C14 and C16, to be switched into circuit.

It will be noted that the rumble and scratch filter switches and the turnover point switches are all shunted by high value resistors. These ensure that the capacitors they control have the same DC voltage applied to them whether they are switched into circuit or not. This eliminates the clicks that would otherwise occur due to the capacitors charging when switched into circuit. The overall gain of the Consonant (x3) is provided by the transistors in the tone control section, T3 and T4.

At the output of the Consonant is the balance control, P7. R33 and P7 are AC coupled to the collector of T4 via C20 and thus form part of the collector load resistance which determines the gain of this stage. As P7 is turned anticlockwise its resistance increases, increasing the collector load resistance of T4 and hence the gain of the left channel. P7', the balance control for the right channel, is connected the opposite way round to P7', so that as the control is turned anticlockwise its resistance falls and the gain of the right channel decreases. When the balance control is turned clockwise the resistance of P7' increases while that of P7 decreases, so the gain of the right channel rises whilst that of the left channel falls. With the balance control

central the resistance of P7 equals that of P7', so the gain of both channels is, of course, the same.

This arrangement has advantages over the single-gang potentiometer which performed a similar function in the Preco. Due to the contact resistance between wiper and track not being zero, crosstalk could occur along the balance potentiometer track in the Preco. With the two-gang potentiometer used in the Consonant this cannot occur. However, a single-gang potentiometer may be used if desired, as will be described later.

The final control in the Consonant is the stereo image width control. Various explanations of the operation of width controls have been given in *Elektor*, so only a brief description will be given here. When S4 is closed the left and right channels are linked via R35 and P3. R35 joins the emitters of T4 and T4' and thus effectively converts these two stages into a differential amplifier. The signal that now appears at the collector of T4 will thus no longer be simply the left channel signal, but $L - kR$, where k is a constant determined by the circuit parameters. In other words the signal in the left channel will consist of the original left signal plus an antiphase contribution from the right channel, this being the significance of the minus sign. Similarly, the right channel signal will consist of $R - kL$. The effect of an antiphase right channel in the left channel is to make the right channel signal appear even further to the right, and a similar effect is apparent in the left channel, i.e. the image width is greater than normal.

P3, on the other hand, allows mixing of in phase signals between channels, i.e. $L+R$ and $R+L$ signals, the exact pro-

Figure 1. Block diagram of one channel of the Consonant.

Figure 2. Complete circuit of the left channel of the Consonant, including the power supply, which is common to both channels. The right channel is identical.

Figure 3. Frequency response of the Consonant with all filters and tone controls cancelled.

Figure 4. Response of the scratch and rumble filters.

5

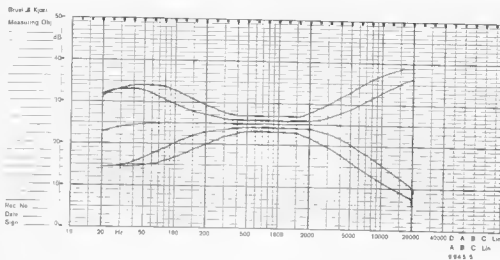

6

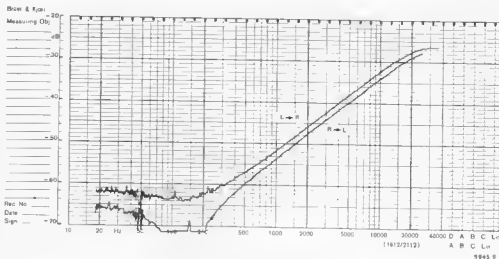

portion of each signal that appears in the opposite channel depending on the setting of P3. With P3 set to minimum resistance complete mixing of both channels will occur and a mono output will result. When P3 is set to maximum resistance it will have little effect and the super-stereo image produced by antiphase signal mixing will result.

Approximately mid-way between these two extreme positions the +R signal introduced into the left channel via P3 will cancel the -R signal introduced by R35, so only the L signal will appear in the left channel. Similarly only the R signal will appear in the R channel, i.e. a normal stereo image will be produced. Of course, it is also possible to obtain normal stereo image width by switching out the image width control using S4 so that there is no cross-connection between the left- and right channels.

Power supply

The control amplifier requires a stabil-

ised supply of approximately 21 V which consists of zener diode D1 and T5 in figure 2. This also provides the supply to the disc preamp. Provision is also made for an IC regulator to provide the +15 V supply which will be necessary if a LED signal level indicator is incorporated into the circuit. This indicator may consist of the PPM and UAA180 LED voltmeter described in *Elektor 33*, January 1978. Alternatively, the 'Luminant', a sophisticated LED meter which displays peak and average signal levels simultaneously, is described elsewhere in this issue.

Performance

The measured performance of the Consonant is illustrated in figures 3 to 8 and in the table of specifications. Figure 3 shows the frequency response of the amplifier with all filters and tone controls cancelled. Figure 4 shows the same curve with the scratch and rumble filter characteristics superimposed. The

response curves of the tone controls, showing the effect of the switchable turnover frequencies, are given in figure 5.

The two graphs for crosstalk, left channel crosstalk on right channel and vice versa, are given in figure 6. As is to be expected, channel separation is best at low frequencies and deteriorates towards the high-frequency end due to stray capacitance coupling between the two channels. Nevertheless, crosstalk at 1 kHz is a healthy -50 dB relative to 0 dB = 775 mV RMS at 1 kHz. Slight differences between the L on R and R on L crosstalk figures are due to inevitable asymmetry in the left- and right channel layout on the p.c. board.

Second-harmonic distortion is measured at three different levels in figure 7, -10 dBm, 0 dBm and +10 dBm. Even at +10 dBm, when the amplifier output is 2.45 V RMS or 6.92 V peak-to-peak, the second-harmonic distortion does not exceed 0.23% at any frequency! At the normal operating levels of the amplifier

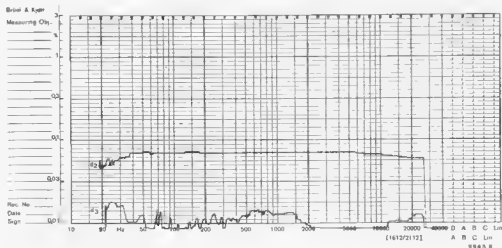
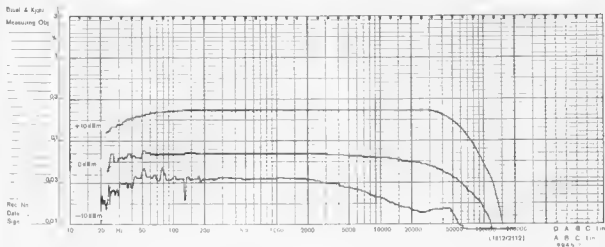

second harmonic distortion is, as might be expected, considerably lower, less than 0.07% at 0 dBm and less than 0.04% at -10 dBm.

Furthermore, the distortion produced by Consonant is predominantly the less objectionable second-harmonic, as figure 8 illustrates. Second-harmonic distortion relative to 0 dBm = 775 mV is again shown in the upper trace, whilst the lower trace is the corresponding third-harmonic distortion, which is below 0.02% at all frequencies.

Construction

In this design special emphasis has been placed upon ease of construction, with the result that all components of the control amplifier are mounted on a single p.c. board with no complicated wiring to potentiometers or switches. On the other hand, difficult-to-obtain printed circuit mounting controls have not been used. All potentiometers and switches are mounted on the board by

their fixing bushes and electrical connection to the board is by means of short wire links. In addition to greatly simplifying the wiring this approach has the advantage that the crosstalk figures of the amplifier are much more predictable, not being dependent on wiring layout.

The printed circuit board and component layout for the Consonant are given in figure 9 and require little comment. A suggested layout for the completed amplifier is given in figure 10, showing the positioning of the disc preamp board (Preconsonant) and the boards for the LED level indicator. To avoid earth loops and hum problems the wiring layout shown in this figure should be adhered to. Screened cable should be used for all signal leads. The screens of the cables should not be connected to chassis at the input/output sockets; however, to avoid RF pickup the screen of each cable should be decoupled to chassis at the socket using a 1 nF capacitor.

Figure 5. Frequency response with the tone controls set to maximum boost, flat and maximum cut, showing the switchable turnover frequencies of the controls.

Figure 6. Plot of L on R and R on L crosstalk versus frequency, relative to 0 dBm = 775 mV at 1 kHz.

Figure 7. Second harmonic distortion versus frequency relative to +10 dB, 0 dB and -10 dB.

Figure 8. This graph shows that third-harmonic distortion is significantly less than second-harmonic.

85

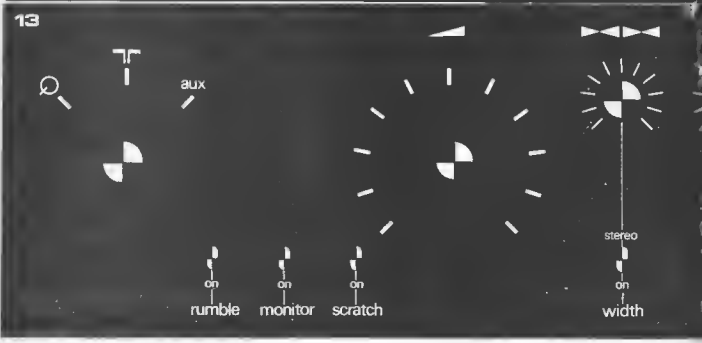
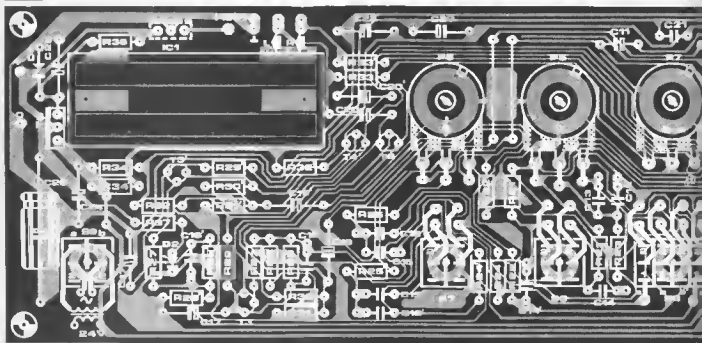
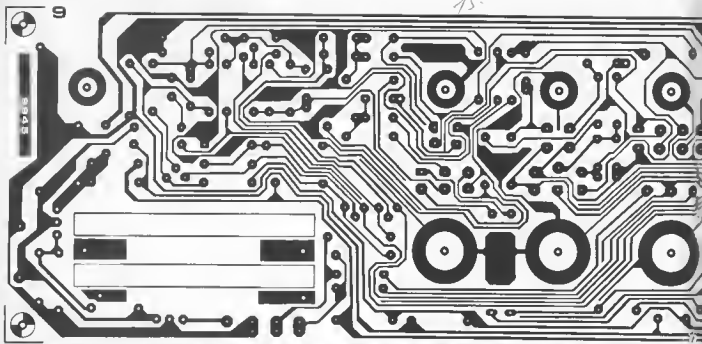

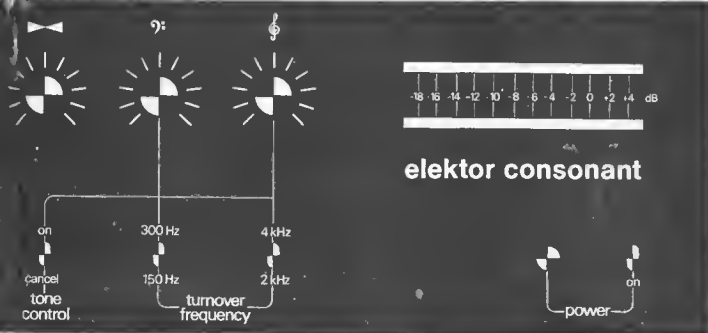
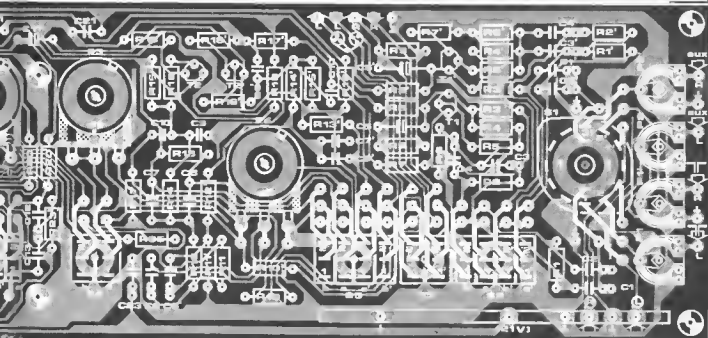
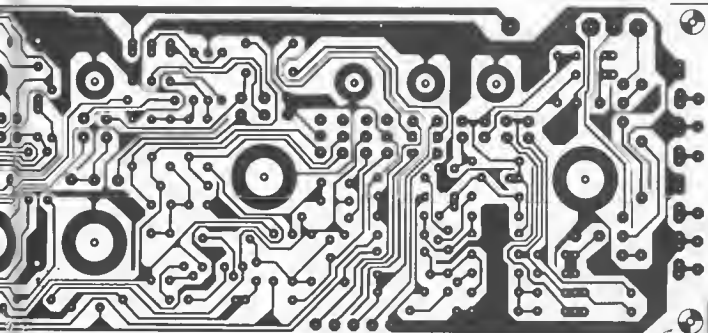

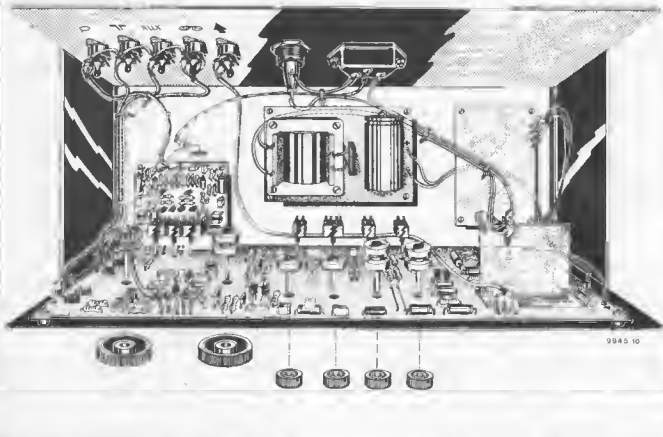

Figure 9. Printed circuit board and component layout for the Consonant (EPS 9945). Right channel components are identified by an apostrophe.

Figure 10. Suggested layout and wiring for the Consonant. Note the 1 nF RF decoupling capacitors on each socket between cable screen and chassis.

Figure 11. Showing the alternative wiring for dual-gang and single-gang balance controls.

Figure 12. The LED meter is fixed to the main p.c. board using stiff wire links, the LEDs protruding through slots in the board.

Figure 13. Fascia panel for the Consonant.

11

a

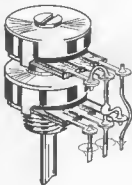

9945 11a

b

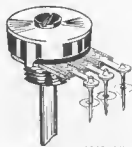

9945 11b

12

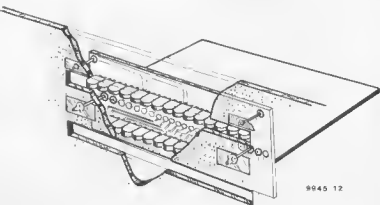

9945 12

Parts list

Resistors:

R1,R1',R2,R2',R13,R13',
R17,R17' = 3M Ω
R3,R3',R6,R6' = 330 k
R4,R4' = 22 k
R5,R5',R16,R16',R18,R18',
R27,R27' = 1 k
R7,R7',R31,R31' = 330 Ω
R8,R8' = 6k Ω
R9,R9' = 100 k
R10,R10' = 8k Ω
R11,R11' = 390 k
R12,R12',R14,R14',
R29,R29' = 33 k
R16,R16' = 47 k
R19,R19' = 27 k
R20,R20',R22,R22' = 18 k
R21,R21',R24,R24' = 1 M
R23,R23',R30,R30' = 4k Ω
R25,R25',R32,R32' = 3k Ω
R26,R26' = 56 k
R28,R28' = 470 k
R33,R33' = 820 Ω
R34,R34' = 100 Ω
R35 = 560 Ω
R36 = 1 k/ $\frac{1}{2}$ W
R37 = 1k8/1 W
P1,P1',P2,P2' = 100 k preset
P3 = 220 k log single-gang
potentiometer
P4 = 22 k log dual-gang
potentiometer
P5,P6 = 47 k lin dual-gang
potentiometer
P7 = 4k7 (5 k) lin single- or dual-
gang potentiometer (see text)

Capacitors.

C1,C1',C3,C3' = 18 n
C2,C2',C4,C4' = 47 n
C5,C5' = 4 μ 7/16 V
C6,C6',C21,C21',C23 = 100 n
C7,C7',C9,C9' = 56 p
C8,C8',C10,C10' = 270 p
C11,C11',C19,C19' = 1 μ /16 V
C12,C12',C13,C13',
C14,C14' = 39 n
C15,C15',C16,C16' = 1n2
C17,C17',C20,C20' = 10 μ /16 V
C18,C18' = 1n5
C22,C22',C24,C25 = 10 μ /25 V
C26 = 220 μ /40 V
C27 = 1000 μ /40 V

Semiconductors:

T1,T1',T2,T2',T3,T3' = BC 179B,
BC 559B or equivalent
T4,T4' = 8C 109C, 8C 549C or
equivalent
T5 = BD 137, BD 139 or
equivalent
IC1 = 7815 (TO-220 case,
see text)
D1 = zener 22 V/400 mW
D2 = LED
S1 = 4 x 1N4001 or 880 C400

Miscellaneous:

S1 = double pole, 3 way
S2,S5,S8 = 4 pole 2 way
S3,S4,S6,S7 = DPDT
S9 = double pole on/off
(250 mA)
T1 = transformer 24 V/250 mA
F1 = fuse 250 mA anti-surge
(slow blow)
heat sinks for IC1 and T5
5 x 5-pin DIN sockets (180°)
5 1 nF capacitors for r.f.
suppression.

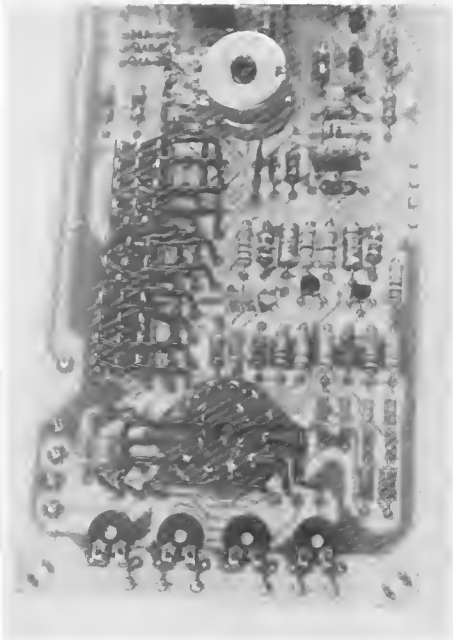

Figure 11 shows the alternative wiring for dual-gang and single-gang balance potentiometers, while figure 12 shows how the LED voltmeter board is fixed to the amplifier panel using stiff wire links or pins.

A front panel fascia for the Consonant is shown in figure 13. Four fixing holes are provided in this steel panel which correspond with the holes in the corners of the p.c. board. Using these holes the board can be mounted behind the front panel with nuts, bolts and spacers. To prevent flexure of the rather long p.c. board two additional fixing holes are provided at the centre of the board, but no corresponding holes are provided in the front panel as it was felt that these would be unsightly. The fixing bolts for these holes should therefore be cemented to the back of the fascia using epoxy adhesive.

The front panel provides screening for the p.c. board and must therefore be earthed, otherwise hum will be picked up from the user whenever the controls are operated.

The fascia panel is longer than illustrated in figure 13 (in fact it is 418 mm in length). This allows the Consonant to be accommodated in a variety of cases simply by trimming the fascia panel to the required length.

54 | luminant

Various types of LED audio level indicator have been described in the past, both of the peak reading and of the average reading type. However, the Luminant represents a novel approach to the problem of audio level measurement, in that peak and average levels are indicated simultaneously on the same display.

Arguments exist for the use of both peak and average reading audio level meters. In a peak level meter the AC voltage is rectified and the peak value stored on a capacitor and displayed on a logarithmic (dB) meter scale. In average reading meters such as the VU (Volume Unit) type of meter the AC voltage is rectified and fed through a lowpass filter so that the average value is indicated.

Proponents of peak meters argue that average reading meters do not respond to short transients, which can result in overload and distortion if the meter is used as a recording level indicator. Afficionados of average reading meters, on the other hand, claim that under-recording can occur with peak meters the ratio of the peak level to average level is high, which it is with much programme material. However, the Luminant offers the best of both worlds by providing simultaneous peak and average readings.

How this is achieved is illustrated in figures 1a to 1c. Figure 1a shows how a thermometer-type LED display responds to a ramp input voltage. As the voltage increases the LEDs light in succession until all are lit, and as the voltage decreases they extinguish in succession starting with the top one. Figure 1b illustrates how a spot-type LED display responds to the same type of input voltage. In this case only one LED at a time is lit.

By using a spot scale for the peak indication and a thermometer scale for the average indication it is possible to

1a

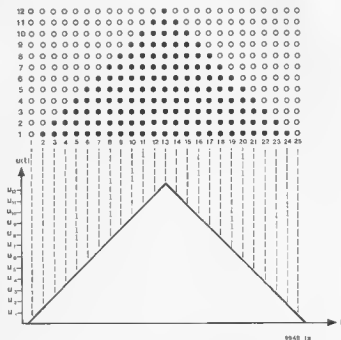

1b

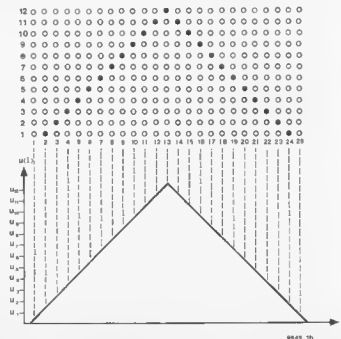

combine peak and average readings into one display, as shown in figure 1c. Since the average level can never be greater than the peak level the display will consist of a column of LEDs indicating the average value with a single LED above it indicating the peak value.

The difference between peak and average reading is illustrated in figure 2, which shows the response of peak and average instruments to a pulse input. The peak meter reaches the maximum value of the input signal very rapidly and decays slowly when the pulse terminates. The average meter, on the other hand, rises more slowly to the maximum value of the input signal, and only reaches it if the pulse is fairly long.

Figures 1a to 1c. Illustrating the difference between thermometer scale and spot scale LED displays, and showing how the two types of display may be combined.

Figure 2. Showing the different responses of peak and average rectifiers to a pulse input.

When the signal finishes the reading decays with the same time constant as its attack time constant.

Display multiplexing

In order to display peak and average readings on the same LEDs the display must be multiplexed. This means that the input to the LED meter must be switched between the outputs of the peak and average rectifiers, and the display must also be switched between thermometer and spot scale. The multiplexing is taken a stage further by using the same LED voltmeter for both the left and right channels of a two-channel display, and switching the outputs of the meter between two sets of LEDs.

The principle of the display multiplexing is shown in figures 3a to 3e. Figure 3a illustrates the basic concept of a spot scale LED voltmeter. This consists of a chain of voltage comparators whose non-inverting inputs are fed with the input signal and whose inverting inputs are fed with reference voltages derived from a (logarithmic) potential divider chain. When the input voltage exceeds U_X the output of K_X goes high and D_X lights. When the input voltage exceeds U_{X+1} the output of K_{X+1} also goes high, so D_{X+1} lights, and so on.

The thermometer scale LED voltmeter shown in figure 3b operates in a similar fashion, but the LEDs are connected to ground instead of between the outputs of the comparators. Once a LED is lit it therefore remains lit even when subsequent LEDs light.

The principle of multiplexing between these two types of display is illustrated in figure 3c. When the peak input signal, U_A , is fed in via $S1$, $S2$ is open and a spot scale results. However, when $S1$ is set in its other position to receive the average input, U_B , $S2$ is closed and the cathodes of the LEDs are grounded so that a thermometer scale is obtained.

Switching between left and right channels is shown in figure 3d. Switches $S1_A$ to $S1_d$ select left peak, left average, right peak or right average signals, whilst switches $S3$ and $S3'$ select between the left and right channel LED displays. As before, $S2$ selects between peak and average readings.

By closing switches in the correct combination it is therefore possible to display left peak and average reading on the left-hand display and right peak or average reading on the right-hand display. If switching between the various inputs and displays is carried out at sufficiently high speed then the eye is, of course, fooled into thinking that it sees four continuous displays. In the practical circuit this switching is carried out electronically, using CMOS analogue switches for the signal inputs and transistors to switch the displays.

Switching between the four displays possibilities is under the control of a clock generator which consists of a two

1c

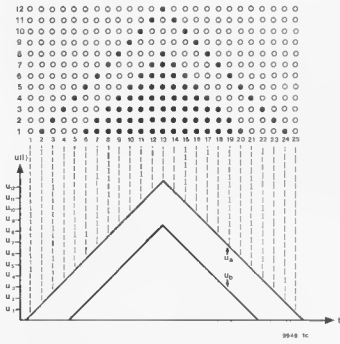

2

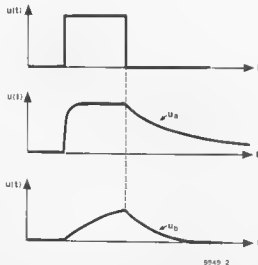

3a

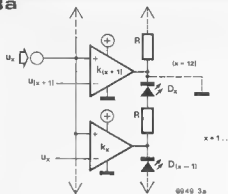

b

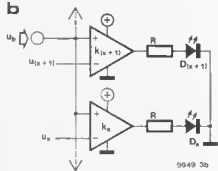

c

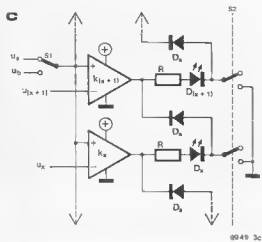

d

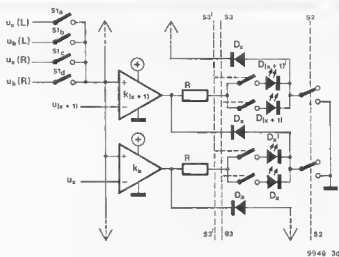

e

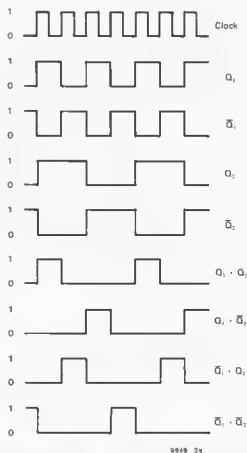

Figures 3a to 3e. These figures show how the LED displays are multiplexed for left, right, peak and average readings.

Figure 4. Rectifier and control section of the Luminant.



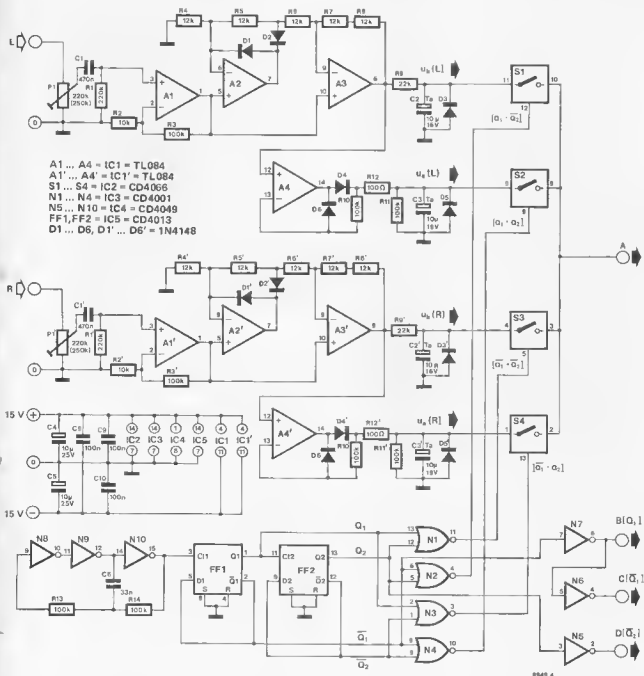

bit binary counter and logic gating. If the following values are assigned:

- Q1 = 1 = left channel display
- Q2 = 0 = right channel display
- Q2 = 1 = peak display
- Q2 = 0 = average display

then the following control signals are required for switches S1 to S3, assuming that a logic 1 is required to close a switch:

- Q1·Q2 for S1a
- Q1·Q2 for S1b
- Q1·Q2 for S1c
- Q1·Q2 for S1d
- Q1 for S3
- Q1 for S3'
- Q2 for S2

These control signals are illustrated in the timing diagram of figure 3e. The

multiplex clock frequency can be anywhere between 100 Hz and 200 Hz, which is sufficient to assure a flicker-free display without being so high as to cause such problems as 'ghosting' due to switching delays.

Complete circuit

The complete circuit of the Luminant is shown in figure 4 and 5. Figure 4 shows the signal rectifier and control section whilst figure 5 shows the display section. The left channel input amplifier and rectifier section is constructed around a TL084 quad FET op-amp A1 to A3, the right channel being identical. A1 is an input buffer amplifier with a gain of 11. P1 allows adjustment of the input sensitivity to suit individual require-

ments. A2 and A3 form an active full-wave rectifier circuit, which gives a positive full-wave-rectified signal at the output of A3. Averaging is performed by a simple lowpass filter R9/C2, whilst peak storage is performed by A4 and its associated components. CMOS analogue switches S1 to S4 are connected to the outputs of the four rectifier circuits.

The clock generator consists of an astable multivibrator constructed around N8 to N10, a two-bit counter comprising FF1 and FF2, and decoding consisting of N1 to N7.

The display section shown in figure 5 consists of a LED voltmeter comprising comparators K1 to K12, together with switching circuits for the various display options. Switching between spot and

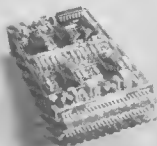
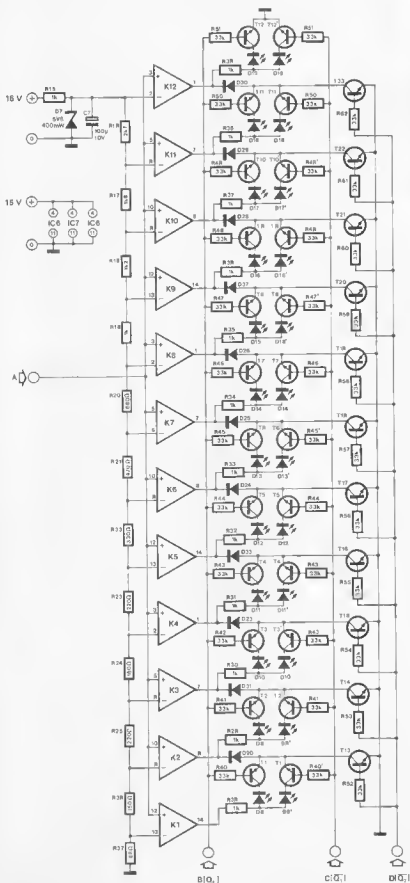

Table 1

Luminant scale calibration

Top LED lit	nominal level (dB)	actual level (dB)
D19	0	0
D18	-3	-3.1
D17	-6	-6.0
D16	-9	-8.7
D15	-12	-11.8
D14	-15	-14.8
D13	-18	-17.8
D12	-21	-20.6
D11	-24	-23.3
D10	-27	-26.3
D9	-33	-32.3
D8	-42	-42.4

Figure 5. Display section of the Luminant.

Figure 6. Printed circuit board for figure 4 (EPS 9949 - 1).

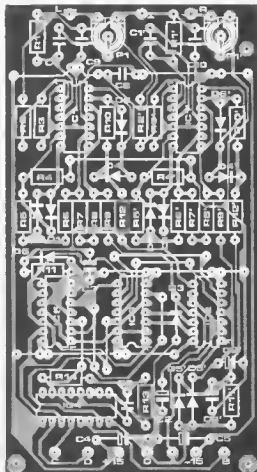
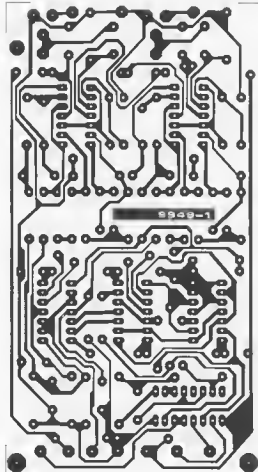

Parts list to figures 4, 5, 6, 7 and 8

Resistors

R1, R1' = 220 k
 R2, R2' = 10 k
 R3, R3', R10, R10', R11, R11', R13,
 R14 = 100 k
 R4, R4', R5, R5', R6, R6', R7, R7',
 R8, R8' = 12 k
 R9, R9' = 22 k
 R12, R12' = 100 Ω
 R15, R19, R28 ... R39 = 1 k
 R16 = 2k7
 R17 = 1k8
 R18 = 1k2
 R20 = 680 Ω
 R21 = 470 Ω
 R22 = 330 Ω

R23, R25 = 220 Ω
 R24 = 180 Ω
 R26 = 150 Ω
 R27 = 68 Ω
 R40 ... R51, R40' ... R51',
 R52 ... R62 = 33 k (total of
 35 pieces)
 P1, P1' = 250 k (220 k) preset
 potentiometer

Capacitors:

C1, C1' = 470 n
 C2, C2', C3, C3' = 10 μ /16 ... 35 V
 tantalum
 C4, C5 = 10 μ /25 V
 C6 = 33 n
 C7 = 100 μ /10 V
 C8, C9, C10 = 100 n

Semiconductors

A1 ... A4 = IC1 = TL 084
 (Texas Instruments)
 A1' ... A4' = IC1' = TL 084
 (Texas Instruments)
 S1 ... S4 = IC2 = CD 4066
 N1 ... N4 = IC3 = CD 4001
 N5 ... N10 = IC4 = CD 4049
 FF1, FF2 = IC5 = CD 4013
 K1 ... K4 = IC6 = LM 324
 K5 ... K8 = IC7 = LM 324
 K9 ... K12 = IC8 = LM 324
 D1 ... D6, D1' ... D6',
 D20 ... D30 = 1N4148
 D7 = zener 5V6 (6%) 400 mW
 D8 ... D19, D8' ... D19' = LED
 T1 ... T12, T1' ... T12',
 T13 ... T23 = TUN

thermometer displays is performed by transistors T13 to T23. When these are turned on (equivalent to closing S2 in figure 3c) a thermometer scale results, whilst if they are turned off a spot scale is obtained.

Switching between left and right channels is performed by transistors T1 to T12'. When T1 to T12 are turned on the left channel display D8 to D19 is active; when T1' to T12' are turned on the right channel display D8' to D19' is active.

The reference voltages for the LED voltmeter are derived from zener diode D7 via a potential divider chain comprising R16 to R27. Taking the voltage applied to K12 as 0 dB the reference voltages are in approximately 3 dB steps down to about -27 dB (K3). The last two steps are approximately 6 dB and 9 dB. Due to preferred resistor values being used in the potential divider chain the exact values differ from the above figures, the actual values being given in table 1.

Construction

The circuit of figures 4 and 5 is accommodated on three printed circuit boards. The rectifier and control section is mounted on the board shown in figure 6, the display drive circuitry is mounted on the board shown in figure 7 and the LEDs are mounted on the board shown in figure 8.

To save space some of the components on the display board are mounted vertically. The commoned ends of R40

to R51, R40' to R51', R52 to R62 and the emitters of T13 to T23 are joined by wire links on the component side of the board, as shown in the component overlay of figure 7.

Particular care should be taken when assembling this board due to the compact layout. Once the three boards have been assembled the display drive board and the display board can be joined by butting them together at right angles and making solder bridges between the pads on the end of the display drive board and the corresponding pads on the display board. Extreme care should be taken during this operation to avoid any shorts between adjacent tracks. The control board may then be mounted parallel to the display drive board using spacers and the two boards interconnected with short wire links between points A, B, C, D, 0 and +15 V.

The only other points worth noting regarding the construction are that C2, C3, C2' and C3' should be tantalum types for low leakage, whilst IC1 and IC1' must be type TL 084. The temptation to use the cheaper, pin-compatible LM 324 should be resisted, as this IC does not have FET inputs and has poorer performance.

Power supply

The Luminant operates from a symmetrical ± 15 V supply. The current drawn from the negative supply is between 15 and 25 mA, whilst that drawn from the positive supply is about 25 mA plus 12 mA per LED, a total of about 170 mA with all LEDs lit. The circuit of a suitable power supply is given in figures 9a and 9b.

Figure 9a shows how an unregulated positive and negative supply may be obtained from a transformer having a single, untapped secondary winding, whilst figure 9b shows a simple stabiliser circuit. If the Luminant is used with the Consonant control amplifier then the arrangement of figure 9a may be used to obtain the negative supply from the Consonant mains transformer. However, only the negative stabiliser need be used as the Consonant has provision for an on-board +15 V IC regulator.

If the Luminant is used with a power amplifier having a symmetrical supply then the circuit of figure 9b may be connected direct to the supply rails of the amplifier. Finally, if the Luminant is used with a preamp or control amplifier having a ± 15 V supply, it may be connected direct to the preamp supply without the need for stabiliser circuits.

Figure 7. Printed circuit board for the display drive circuitry (EPS 9949 - 2).

Figure 8. Printed circuit board for the LED display (EPS 9949 - 3).

Figures 9a and 9b. Power supply suitable for the Luminant.

missing link

Modifications to
Additions to
Improvements on
Corrections in
Circuits published in **Elektor**

Elbug

It is possible to make a small but significant improvement in Elbug, the monitor software routine for the Elektor SC/MP system. Elbug utilises location $\text{\$FE0}$ as an address flag for the cassette routine. However this location is also used by the modify routine, with the result that certain complications arise if one wishes to run the cassette routine at a speed of other than 600 baud. The end of a cassette transfer is no longer indicated by the word 'Elbug' appearing on the display, unless the data being transferred (from cassette to memory) is always accompanied by the start- and finish addresses.

The above problem can be resolved by reserving a different location as address flag for the cassette routine. This can be done by modifying the contents of $\text{\$2FF}$, $\text{\$353}$ and $\text{\$374}$ (these addresses correspond to locations $\text{\$FF}$, 153 and 174 in EPROM II). Until now, the contents of these addresses were $\text{\$0}$, i.e. they were unprogrammed locations, which means that they can still be modified. By programming $\text{\$10}$ into these locations, address $\text{\$FF0}$ will be reserved as address flag for the cassette routine. This address will remain unaffected by the modify routine.

Once the above modification has been carried out, the cassette transfer routine will function satisfactorily at any desired speed.

* * *

RAM I/O

When the RAM I/O card is used in conjunction with the CPU- and extension card, the value of resistors R14...R21 should be reduced to between 470 Ω and 1 k. Since the TTL ICs connected to the address bus cause excessive loading, the '0' level can be as high as 1.4 V. This is remedied by altering the value of the above-mentioned resistors.

coming soon

piano



oscillographics



car start booster

puffometer

24 dB VCF

digiscope

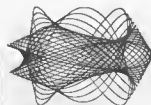

55 IC counter timebase

A new Mostek IC, the MK 5009, is a complete timebase for frequency counters and other applications. The internal block diagram of the IC is shown in figure 1. It incorporates a clock circuit (which may be used either with an external reference frequency, with an external RC circuit or with an external crystal) and a programmable divider. By applying an appropriate binary code to the programming inputs the division ratio may be varied in decade steps from 10^0 to 10^8 . Other division ratios are also available, the most interesting being divide-by- 2×10^6 , which gives a 50 Hz output with a 1 MHz clock frequency or a 60 Hz output with a 1.2 MHz clock frequency.

A practical circuit using the MK 5009 is shown in figure 2, whilst table 1 shows the division ratios that may be obtained for the different settings of S1 to S4. A 1 MHz crystal is used in a parallel resonant circuit and this crystal should be a 30 pF parallel resonant type.

The divided down output is available at pin 1 of the IC. This output will drive CMOS circuits or one TTL unit load directly. However, since the IC is fairly expensive it is recommended that a permanent buffer stage be connected to the output. This may take the form of a TTL or CMOS gate or buffer, a FET or a bipolar transistor. The 1 MHz clock frequency is available at pin 10 of the IC and must similarly be buffered if it is to be used.

Trimming of the oscillator frequency for maximum accuracy can be carried out using C2. With the division ratio set to 10, C2 can be adjusted for zero beat between the output and an accurate frequency such as the 200 kHz Droitwich transmitter.

S1	S2	S3	S4	division ratio
0	0	0	0	10^0
0	0	0	1	10^1
0	0	1	0	10^2
0	0	1	1	10^3
0	1	0	0	10^4
0	1	0	1	10^5
0	1	1	0	10^6
0	1	1	1	10^7
1	0	0	0	10^8
1	0	0	1	6×10^7
1	0	1	0	36×10^6
1	0	1	1	6×10^8
1	1	1	0	2×10^9

0 = switch closed
1 = switch open

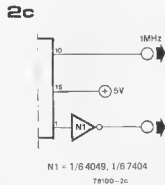
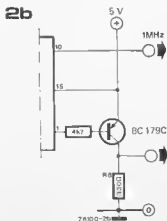
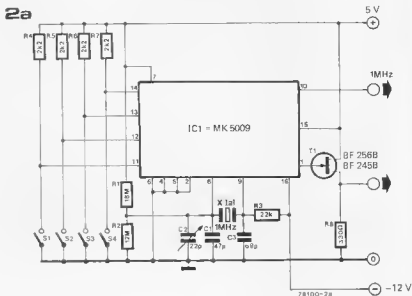
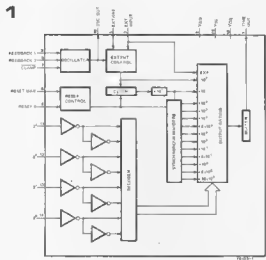

digital delay line 56

There are several applications for a circuit that can delay digital signals, the Digital Reverberation Unit described in the recent May issue of *Elek* for being but one example.

The most common method of delaying digital signals is to use a shift register. The circuit shown in figure 1 may therefore appear somewhat unusual, in that the two most prominent components are not shift registers but Random Access Memories (RAMs; IC2 and IC3). In this circuit, the digital data are stored in the RAMs for the duration of the desired delay period and then recalled and presented at the 'delayed data' output. Since the 1024-bit RAMs used here (type 2102) are relatively inexpensive, there is no need to skimp on memory space — if longer delay times are desired, the circuit can easily be extended as will be described later.

The circuit operates as follows. A clock signal is fed to three 4-bit binary counters, connected in cascade to produce a 12-bit counter. The first ten bits from this counter are applied to the address inputs of both RAMs. The eleventh bit is used to drive the read/write control input of the memories; inclusion of N3 in the feed to IC3 ensures that when IC2 is being read out (read mode) IC3 is storing the input data (write mode), and vice versa. In other words, the two RAMs are used alternately: when the contents of one are being scanned and fed to the output, the other is storing new data; when this cycle is completed the first RAM is used to store the incoming data and the second is read out.

No logic gating is required to route the incoming data to the correct RAM: all data are presented to the data input of both RAMs. The memory which is in the Write mode will store the data, whereas the other will simply ignore them. The same is not true, however, for the data output: gates N1 and N2 are required to select the correct output at any given time.

As mentioned earlier, the delay line can be extended by adding further RAMs. The alternating read/write operation used in this system involves using an additional pair of RAMs for each extension step. However, little more is required: the address inputs of the additional RAMs are simply connected in parallel with the existing address lines and the same read/write signal is

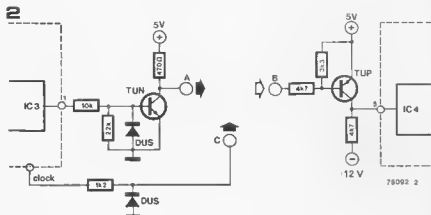
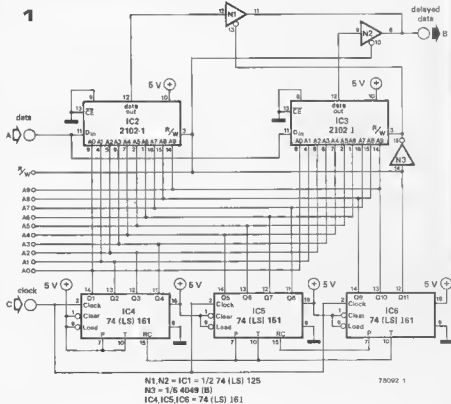

applied. Gates N1 . . . N3 must be repeated for each further pair of RAMs. The 'delayed data' output of the first pair is connected to the 'data input' of the second pair, and so on down the line.

This digital delay line can be used in the Digital Reverberation Unit mentioned earlier. Each pair of RAMs will replace one shift register IC. However, since the logic levels are

not identical a simple interface circuit is required at both ends of the digital delay line. Figure 2 shows the principle: the output from IC3 in the original circuit is buffered by a single transistor and fed to the 'data' input of the delay line described here; the output from the delay line is again buffered by a single transistor and fed to the input of IC4 in the original circuit.

57

digital audio mixer

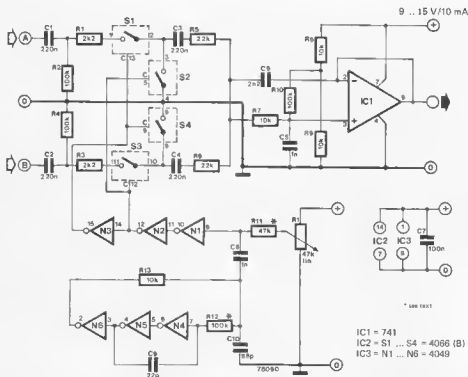

A novel approach is employed in this circuit, which allows mixing of two audio signals and cross-fading between them. Rather than using conventional potentiometers as analogue attenuators together with a summing amplifier, the circuit functions by sampling the two signals alternately at a high frequency. The input signals are fed to a pair of electronic switches each comprising two elements of a 4066 CMOS analogue switch IC. The use of a switch in shunt with the signal path as well as in series allows a high load impedance to be used (for low distortion) whilst at the same time maintaining good signal isolation when the switch is 'off'.

The two switches are opened and closed alternately by a 100 kHz, two-phase clock constructed around N1 to N6. When S1 is closed, S2 is open and signal A is fed through to IC1. S3 however, is open and S4 closed, so signal B is blocked. When S3 is closed and S1 open then signal B is, of course, passed while A is blocked. P1 allows the duty-cycle of the clock pulses to be adjusted, i.e. the proportion of the total time for which each signal is passed. This in turn varies the amplitude of each signal. With P1 in its mid-position both signals have approximately the same amplitude whilst at the two extremes one signal is completely blocked whilst the other is passed

continuously. A lowpass filter built around IC1 removes any clock frequency components from the output. Although these are inaudible they could, if not filtered out, damage power amplifiers and loudspeaker tweeters or beat with the bias oscillator in a tape recorder to cause high-pitched bleeping tones. The supply voltage, which should be stabilised and ripple-free, may lie between 9 V and 15 V. Above 15 V the CMOS ICs may be damaged and below 9 V the 741 will not function satisfactorily. The maximum input signal that the circuit will accept without distortion is about 1 V RMS.

58

cheap crystal filter

In view of the dramatic drop in the price of crystals used in colour TV sets, they now represent an economical way of building an SSB-filter. The circuit shown in the accompanying diagram is for a filter with a -6 dB bandwidth of roughly 2.2 kHz.

The layout for the p.c.b. indicates

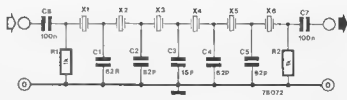

X1...X6 = 4 453818MHz X141

how such a circuit can be constructed. This type of arrangement has the advantage that the input and output are as far as possible apart from one another, so that rejection outside the passband is at a maximum. By terminating the input and output with a 1 k resistor in parallel with an 18 pF trimmer capacitor, passband ripple can be tuned down to 2 dB. The most important specs are given in the accompanying table, to which should be added that the out-of-band attenuation is 90 dB.

Parts list.

Resistors:
R1, R2 = 1 k

Capacitors:
C1, C2, C4, C5 = 82 p
C3 = 15 p
C6, C7 = 100 n ceramic

Miscellaneous:
X1, X2, X3, X4,
X5, X6 = 4.433,618 kHz

Table.

f_0	4432,03 kHz	
$f_{-6 \text{ dB (r)}}$	4433,06 kHz	B-6 dB 2,26 kHz
$f_{-6 \text{ dB (l)}}$	4430,70 kHz	
$f_{-60 \text{ dB (r)}}$	4435,30 kHz	B-60 dB 7,90 kHz
$f_{-60 \text{ dB (l)}}$	4427,40 kHz	
slope factor (r)	1:3,17	
slope factor (l)	1:3,46	
ripple	2 dB	



touch controller

59

H. de Grauw

This simple touch controller gives a DC output voltage which can be varied by two pairs of touch contacts and may be used to drive a variety of voltage-controlled circuits such as voltage-controlled oscillators, voltage-controlled attenuators and amplifiers.

The circuit consists of an inverting integrator based on IC1. When the circuit is switched on the non-inverting input of IC1 will be held at half supply voltage by R2 and R3. The inverting input must also be at the same potential, and since C1 is initially uncharged the output of IC1 will also be at half supply.

If the lower pair of touch contacts is bridged by a finger then current will flow through R1 to ground.

Since negligible current can flow from the inverting input of IC1 this current must be provided by the output of IC1, whose voltage rises to drive charge into C1 and thus maintain the inverting input of IC1 at the same potential as the non-inverting input.

When the upper pair of touch contacts is bridged then current will flow from the positive supply through R1 into C1 and the output voltage of IC1 will fall. The output of IC1 may be used to

drive virtually any voltage-controlled circuit. A simple voltage-driven gain control for audio circuits is shown in figure 2. This consists of a lamp, driven from the output of IC1 via a transistor, whose brightness varies with the output voltage of IC1, thus changing the resistance of the LDR which forms part of an attenuator. Due to the input bias current of IC1 the output voltage will tend to drift with time. If long-term stability of the output voltage is required then the 741 should be replaced with a FET input op-amp such as a 3130, 3140 or LF 356.

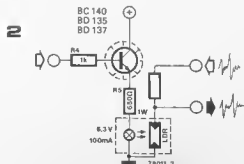
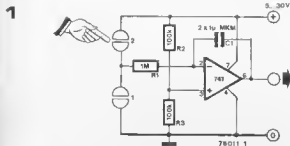

FET millivoltmeter

FET opamps have high gain, low input offset and an extremely high input impedance. These three characteristics make them eminently suitable for use in a millivoltmeter. The circuit presented here can measure both voltages and currents.

Figures 1a and 1b show the basic circuits for voltage and current measurement respectively. In figure 1a, the opamp is used in a virtual earth configuration and the gain is therefore determined by the ratio R_a/R_b and by the voltage divider circuit R_c/R_d . The exact formula is given in the diagram. The current measurement circuit, figure 1b, is also basically a virtual earth configuration; the opamp will maintain an output voltage such that the left-hand (input) end of R_a is at zero potential and, since the input current must flow through this resistor, the voltage drop across R_a equals $I \times R_a$. Therefore, the output voltage must be $-I \times R_a$. The complete circuit (figure 2) combines these two functions. The range switch S3 selects the required feedback resistor (R_a in figure 1) and the voltage divider (R_c and R_d) if the latter is required. The resulting ranges are listed in Table 1. The polarity of the meter can be reversed by means of switch S2.

A symmetrical ± 3 V supply is required, capable of delivering 1 mA. This low voltage and low current consumption means that the FET millivoltmeter can be battery-powered. This is a highly desirable feature, since the meter can then be used for so-called 'floating'

measurement. A higher supply voltage is permissible, if it is easier to obtain (4.5 V flat batteries, for instance); the maximum for these opamps is a symmetrical ± 16 V supply.

It is advisable to use 1% resistors, and P1 and P2 should preferably by high-quality preset potentiometers. R1, R2 and R3 may prove difficult to obtain, in which case a series-chain of 1 M resistors must be used.

Preset P1 is for offset compensation. With the meter input shorted, this preset is adjusted until the meter reads zero. P2 is the calibration potentiometer: a known voltage (or

current) is applied and P2 is set so that the meter reads correctly.

Figure 3 shows an optional extra: the 'universal shunt'. This consists of nothing more than a chain of resistors that can be connected across the voltage input terminals of the meter. If current is passed through any one of these resistors, a corresponding voltage drop will appear across this resistor. Since there is no voltage drop across any of the other resistors, this voltage will be indicated by the meter. Table 2 lists the resulting current measurement ranges. As before, 1% resistors should be used for the actual measuring chain (R19...R24).

Table 1

S3	U_i (f.s.d.)	I_i (f.s.d.)
a	10 mV	1 nA
b	50 mV	5 nA
c	100 mV	10 nA
d	500 mV	50 nA
e	1 V	100 nA
f	5 V	500 nA
g	10 V	1 μ A
h	50 V	5 μ A
i	100 V	10 μ A
j	500 V	50 μ A
k	1000 V	100 μ A

Table 2

S3 in position:	a	b	c
I_a (f.s.d.)	1 μ A	5 μ A	100 μ A
I_b (f.s.d.)	10 μ A	50 μ A	100 μ A
I_c (f.s.d.)	100 μ A	500 μ A	1 mA
I_d (f.s.d.)	1 mA	5 mA	10 mA
I_e (f.s.d.)	10 mA	50 mA	100 mA
I_f (f.s.d.)	100 mA	500 mA	1 A

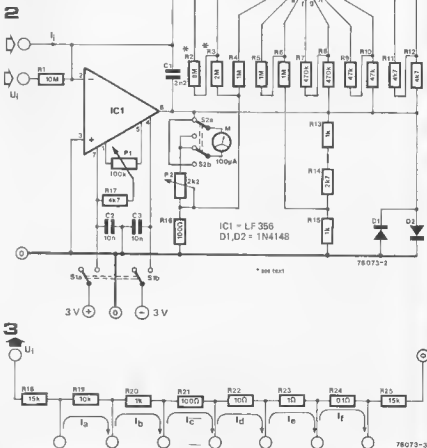
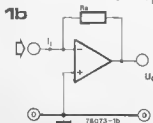
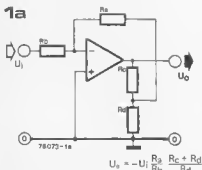

word trigger

61

Willem v. Rooyen

When troubleshooting complex digital equipment such as a microprocessor, satisfactory triggering of an oscilloscope can be difficult to achieve. The trigger circuit of an oscilloscope is designed to give a stable trace on the screen by initiating the timebase sweep at the same point on successive cycles of a periodic waveform, which it achieves by monitoring the amplitude and polarity of the signal. In a digital system all signals have the same amplitude and polarity and are frequently aperiodic, consisting of an irregular stream of '0's' and '1's'. It is therefore difficult to obtain a stable trace on the oscilloscope and virtually impossible to trigger on a selected section of the waveform. The solution is to use a 'word trigger'. This consists of an eight-bit digital comparator which is loaded with a preselected binary word. The inputs of the comparator are connected to various points in the circuit under test, for example to the address or

data bus lines of a microprocessor system. When the system outputs the preselected word the comparator output goes high and this pulse is fed to the external trigger input of the oscilloscope. The Y inputs of the 'scope can then be used to examine the conditions at various points in the circuit around the time that the preselected word occurs. The comparator consists of an eight-input NAND-gate made up of N17, N18 and N19. The output of this gate will go high only when all inputs are high. Bits which are low in the preselected word must be inverted by feeding through inverters N1 to N15, whilst bits which are high are fed through non-inverting buffers, N16 to N19. The output of this gate will go high only when all inputs are high. Bits which are low in the preselected word must be inverted by feeding through inverters N1 to N15, whilst bits which are high are fed through non-inverting buffers, N16 to N19. These conditions are selected by switches S1 to S8. If the word length is shorter than eight bits or the value of certain bits is unimportant then the unused switches are set to their centre-off position, the 'don't care' position, which causes the corresponding inputs of N17 and

N18 to be held high. To prevent false triggering on short, spurious pulses, the output of N19 is fed to a delay line consisting of N21 to N26, which can be varied from zero to approximately 72 ns in 12 ns steps. Although one input of N20 will go high when the output of N19 goes high, the second input will not go high until after the delay. The signal must therefore be true for a time greater than the delay time before a trigger pulse appears at the output of N20. To allow the circuit to be used with both TTL and CMOS systems, Low-power Schottky TTL devices are used in the design. These are as fast as normal TTL but may be driven directly by CMOS circuits (operating at +5 V). The word trigger may be powered from the +5 V logic supply of the circuit under test and is protected against accidental overvoltage and reverse polarity by a 6.8 V zener diode.

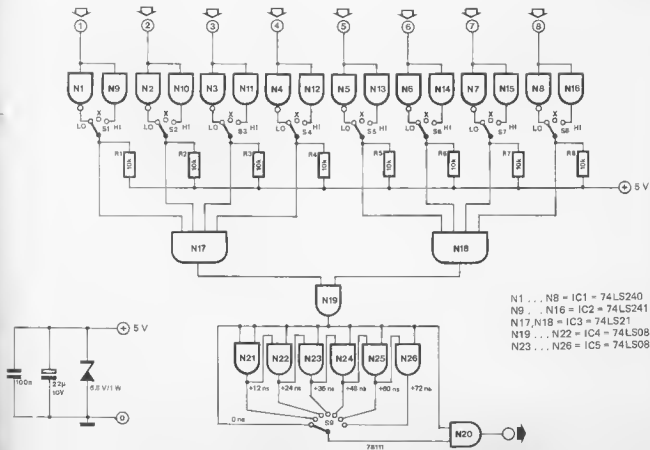

62

electronic variable capacitor

Conventional variable capacitors are not readily obtainable in values above about 500 p, which means that they are not often used in audio and LF circuits. However, using two op-amps connected as voltage followers, a potentiometer and a fixed capacitor, large value variable capacitors may be realised.

Operation of the circuit is easiest to understand if it is assumed that a DC voltage U_i is applied to the input. Since IC1 is connected as a voltage follower this voltage appears at its output. P1 attenuates this so that a voltage kU_i appears at the output of IC2, where k is a constant, less than 1, depending on the setting

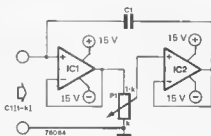

IC1, IC2 - LF 356, 1/4 TL 084

of P1. A voltage $(1 - k)U_i$ therefore appears across C1. The charge, Q , on C1 is thus $C1(1 - k)U_i$ (since $Q = CU$). Since the input voltage is

U_i and the charge supplied by the input source is $C1(1 - k)U_i$, the effective capacitance seen by the

input source is $\frac{C1(1 - k)U_i}{U_i}$, i.e.

$$C1(1 - k).$$

By adjusting P1 the effective capacitance can be varied from effectively zero (except for a few pF stray capacitance) to the full value of C1.

Various types of IC may be used for IC1 and IC2, but FET types with high input resistance are preferred, especially if small capacitance values are used for C1. The value of P1 may be between 10 k and 50 k.

63

variable capacitance multiplier

This circuit operates in a similar fashion to the electronic variable capacitance described above. However, the second voltage follower is replaced by an inverting amplifier, with the result that with P1 at maximum the voltage developed across the capacitor is greater than the input voltage by a factor $(1 + A)$, where A is the gain of A2, which equals $R2/R1$. The input source therefore applies a

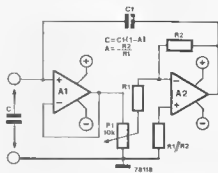

voltage U_i but delivers a charge $C1(1 + A)U_i$, with the effect that the apparent capacitance is $C1(1 + A)$. This is, of course, a derivation of the well-known Miller effect.

Turning P1 back effectively reduces A until, with P1 at minimum, A is zero and the capacitance equals C1. P1 thus allows the multiplied capacitance to be varied from C1 to $C1(1 + A)$.

64

cold shower detector

Anyone who has ever suffered the bone-chilling experience of discovering the hard way that the hot water tap in a shower or bath is pouring out torrents of unexpectedly ice-cold water will require little convincing that this circuit can be useful.

The pilot burner in gas-fired boilers can (and sometimes does) go out. If this unfortunate event goes unnoticed, it is only a matter of time before any difference in temperature between the outflow from the hot and cold taps is purely coincidental. After the pilot burner has been re-lit,

it may take up to half an hour before hot water is again available.

To avoid this harrowing experience, it is necessary to receive early warning if the pilot burner goes out. This can be achieved by measuring the temperature of the boiler's flue. This is usually a metal pipe, which is noticeably warm as long as the pilot burner is on. An NTC (thermistor) can be used to detect the three possible states: pipe cold - pilot burner out; pipe warm - pilot burner on; pipe hot - main burners on. This system is of no use, of course, if an electric storage heater is installed.

In this case it is, however, possible to replace one thermistor (R2) by a fixed resistor and use the other to measure the actual water temperature.

In the application for which the circuit was originally intended, R1 and R2 are used to compare the room temperature with the temperature of the boiler's flue. The actual resistance value of the thermistors is not particularly critical: any value between 1 k and 10 k may be used. If they can be obtained, the types which are mounted on a fixing screw are the best. Otherwise, some

mechanical ingenuity will be required — always bearing in mind the temperatures involved: adhesive tape is useless, and epoxy-type adhesives will be little better, so some form of metal bracket or clamp

is mandatory. Having mounted R1 on the pipe and R2 in free air (on the box in which the circuit is housed, for instance), the circuit can be calibrated as follows. Initially, P2 is set to zero

(wiper to supply common) and P1 is adjusted so that the green LED (D2) just lights. If the pilot burner is now turned off (or R1 removed from the pipe) the red LED (D1) should light within a minute or two. If this is not the case, P1 will have to be readjusted slightly. Once the correct setting of P1 has been found, it is a simple matter to adjust P2. With the main burners on, this preset is turned up until the yellow LED (D3) lights reliably. This adjustment does not influence the setting of P1. The current consumption of the circuit is approximately 25 mA, and any supply voltage between 10 V and 15 V may be used. A very basic supply (transformer, bridge rectifier, electrolytic capacitor) is adequate, since the actual measuring bridge (R1, R2, P1, P2) receives its supply from a stabilised reference voltage output of the IC (pin 10).

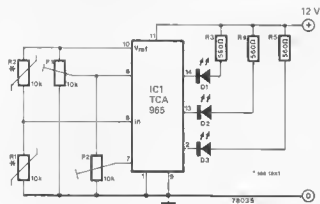

2m transmitter 65

This transmitter which operates on the two-meter (144...146 MHz) band provides an output signal of 1 W into 50 Ω. The circuit is driven

by two signals: a modulated 10.7 MHz signal of less than 1 mW and a 10 mW local oscillator signal with a frequency between 133.3 and

135.3 MHz. These are mixed in a double-balanced Schottky mixer. Gain is applied in three stages: the first stage uses a dual-gate MOSFET, the quiescent current of which should be 10 mA. The DC bias voltage on gate 2 of this FET (which determines the gain of the stage) should be set by means of P1 to 4 V. The quiescent currents of T2 and T3 should be 1 mA and 10 mA respectively. L2 consists of a ferrite bead on the drain of T2. The winding details for the remaining coils are given in the accompanying table. Unless otherwise stated all the coils are air-cored. When using the transmitter, an extra lowpass filter is needed between the output and the aerial to limit the second and third harmonic signal components to acceptable proportions.

Coil	Internal dia.	Gauge	Turns	Taps
L1a	6 mm	21 SWG (1 mm)	4	tap 1 turn from earthy end
L1b	6 mm	21 SWG	4	
L2	see text			
L3a	6 mm	21 SWG	4	
L3b	6 mm	21 SWG	4	
L4	wound on ferrite bead (0.3 mm)	33 SWG	4	
L5	6 mm	21 SWG	3	
L6	wound on ferrite bead	33 SWG	4	
L7	6 mm	21 SWG	2	
L8	8 mm	21 SWG	2	
L9	8 mm	21 SWG	7	
L10	wound on ferrite bead	33 SWG	4	
L11	6 mm	21 SWG	6	

enamelled copper wire used throughout

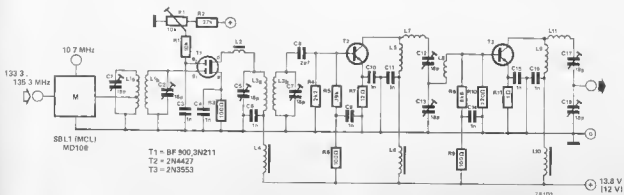

temperature of the plug.
It should be noted that the 2N3055 must be provided with a suitable heat sink.

The circuit can be supplied direct from a car-battery (e.g. via the cigarette lighter), provided it delivers more than 9 V.

Parts list.

Resistors:

R1 = $1\Omega/17\text{ W}$
R2 = $0,47\Omega/9\text{ W}$
R3, R4 = 100 Ω
R5 = 47 Ω
R6, R7, R11, R13, R16,
R17, R18, R20 = 10 k
R8 = 4M7
R9 = 2M2
R10, R14, R15 = 1 k
R12 = 1 M
R19 = 68 k
P1 = 100 Ω lin potentiometer
P2 = 50 k preset potentiometer

Capacitors:

C1 = $1\mu\text{F}/16\text{ V}$
C2 = 220 $\mu\text{F}/16\text{ V}$
C3 = 10 n

Semiconductors:

T1 = 2N3055
T2 = BD 140
D1 = 1N4148
IC1 = 3140
IC2, IC3 = 741

Miscellaneous:

1 calibrated potentiometer knob for P1
1 microammeter 100 ... 500 μA

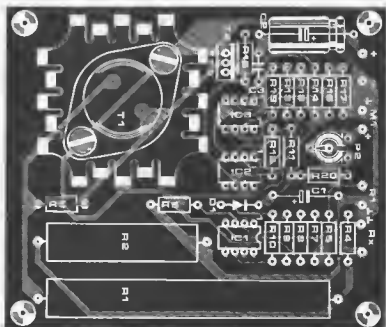
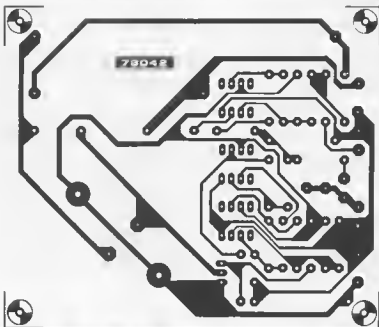

solid-state thermostat 67

The Philips/Mullard TDA 1024 IC is designed for on/off control of triacs and contains a differential comparator and a zero-crossing point trigger. Figure 1 shows a typical application of this IC in a solid-state thermostat to control an electric heating element.

Temperature is sensed by a negative temperature coefficient thermistor, R2. So long as the temperature stays below the preset level the voltage at the junction of R1 and R2 will be greater than that set by P1 and the triac will be turned on continuously

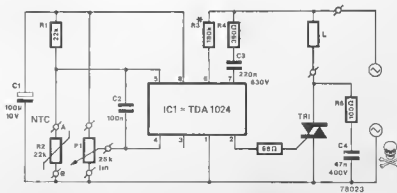

* see text

by bursts of pulses around the zero-crossing point of the mains waveform. As the temperature rises the resistance of R2 will fall, and with it the voltage at the junction of R1 and R2. When this voltage falls below that at the wiper of P1 the comparator output will change state and the circuit will switch off the triac, and hence the heating element. The temperature at which the thermostat cuts out can be adjusted by means of P2. The width of the control pulses may be adjusted by changing R3 from 150 μ s (R3 = 180 k) to 650 μ s (R3 = 820 k). This is particularly important if small loads are to be switched, as the load current near the zero crossing point may be less than the holding current

of the triac. Use of longer trigger pulses keeps the triac triggered until the load current has risen to a level

sufficient to keep the triac conducting. Philips/Mullard Application notes for TDA 1024.

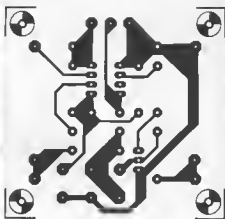
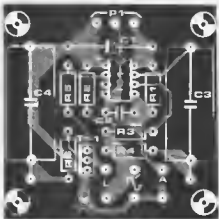

68 stereo vectorscope

Using two UAA170 LED voltmeter ICs it is possible to construct a novel type of stereo indicator which gives a display determined by the amplitude and phase relationship of the two input signals. IC1 is fed with the left channel signal and drives the rows of a 4 x 4 LED matrix, whilst IC2 is fed with the right channel signal and drives the columns of the matrix. At any time one LED in the matrix will be lit depending on the instantaneous amplitudes of the two input signals. Since AC signals are being fed to the circuit the display will be continuously changing, the pattern produced being dependent, not only on the amplitude but on the relative phase of the two signals. For example, if the two input signals have the same frequency then a kind of Lissajous figure will be produced. If they have the same amplitude and phase then this figure will be a diagonal line. The circuit has five adjustment points, P1 and P5 set the quiescent DC bias at the inputs of the two ICs and hence determine which LED in the display is lit with no input signal.

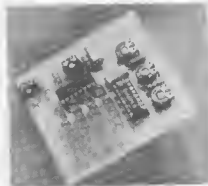
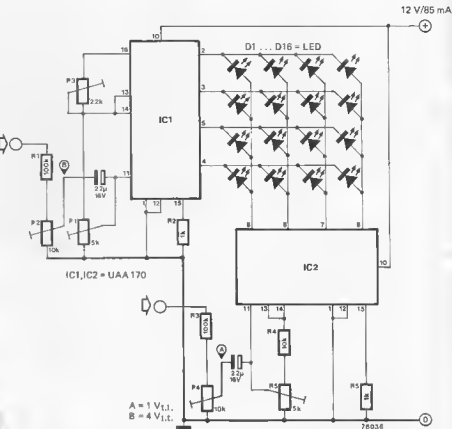

Normally these controls would be adjusted so that the four centre LEDs were all glowing dimly, P2 and P4 adjust the sensitivities of the vertical and horizontal inputs respectively, while P3 sets the display brightness. The current consumption at peak brightness is approximately 100 mA. The sensitivity of the two inputs is different. A 1 V p-p signal is required at the wiper of P4 to give maximum

output level from IC2, whereas 4 V p-p is required at the wiper of P2 for maximum output from IC1. However, by adjusting P2 and P4 and/or varying the values of R1 and R3, the sensitivity of the two inputs can be made the same. For small input signals R1 and R3 may be omitted entirely, but care should be taken to ensure that the peak input voltage at pin 11 of either IC does not exceed 6 V.

car voltage/current regulator 69

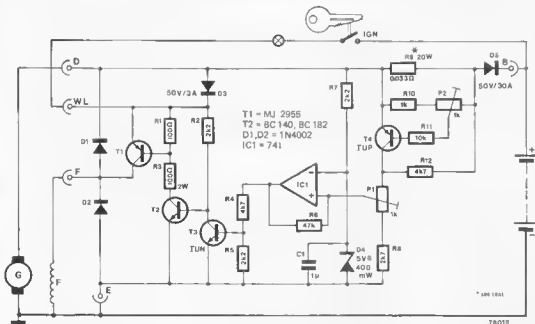

Although many modern cars are equipped with solid-state regulators to control the voltage and current output of the generator, there are still millions of older cars fitted with electromechanical regulators which are potentially unreliable. This circuit is designed as a direct replacement for an electromechanical regulator and, though designed primarily for use with a dynamo it will work equally well with an alternator.

When the operation of a conventional voltage regulator is examined, it is surprising that such regulators can be as reliable as they are. The basic operation of a car voltage regulator is as follows: when the engine is idling the dynamo is supplied with field current via the ignition warning light. The dynamo armature is not connected to the battery at this stage as its output is lower than the battery voltage, and the battery would discharge into it. As the engine speed increases the dynamo output voltage rises. When it exceeds the battery voltage a relay operates which connects the dynamo armature to the battery, thus charging the battery. If the dynamo output rises still further a second relay operates at about 14.5 volts which disconnects the dynamo field winding. The field decays and the output voltage falls until this relay drops out. The relay pulls in and drops out continuously, maintaining the dynamo output at 14.5 V, which prevents overcharging of the battery. A third relay has a winding in series with the dynamo output, through

which the total output current of the dynamo flows. When the safe output current of the dynamo is exceeded, for example when the battery is very flat, this winding operates the relay, which disconnects the field winding of the dynamo. This illustrates only the basic principle, and the exact circuit of the regulator will vary from car to car.

The circuit of an electronic voltage/current regulator is given here. The cut-out relay is replaced by D5, which is reverse-biased when the dynamo output falls below the battery voltage. The battery therefore cannot discharge into the dynamo.

When the ignition is switched on the dynamo field winding receives current via the warning light and T1. D3 is included to prevent current being robbed from the field coil by the much lower resistance of the armature. As the engine speed increases the dynamo output voltage rises, and it begins to supply its own field current via D3 and T1. As the voltage at the cathode of D3 rises the warning light is gradually extinguished. When the dynamo output has reached around 13-14 V the battery begins to charge. IC1 forms a voltage comparator that monitors the dynamo output voltage. As the output voltage rises the voltage at the inverting input of IC1 is initially higher than at the non-inverting input, so the output of the IC is low and T3 is turned off. When the output voltage exceeds 5.6 V the voltage at the inverting input is stabilised at this value by D4. When

the output voltage exceeds the required maximum (adjustable by P1), the potential at the non-inverting input of IC1 exceeds that at the inverting input, so the output of IC1 swings positive. This turns on T3, which turns off T2 and T1, interrupting the dynamo field current. The dynamo field now decays and the output voltage falls until the comparator switches back again. R6 provides a few hundred millivolts of hysteresis which ensures that the circuit functions as a switching regulator. T1 is either turned hard on or cut off and so dissipates relatively little power. Current regulation is effected by means of T4. When the current through R9 exceeds the specified maximum the voltage drop across it causes T4 to turn on. This pulls up the non-inverting input of IC1 and cuts off the dynamo field current. The value given for R9 (0.033 Ω /20 W, made up of 10 0.33 Ω /2 W resistors in parallel) is correct for a maximum output current of up to 20 A. For larger output currents, reduce R9 accordingly.

The circuit can be built into an old regulator box with the same terminal configuration as the original regulator so that it can be connected directly to the existing wiring. The output voltage and current of the unit should be adjusted using P1 and P2 to suit the specification of the original regulator. T1 and D5 must be mounted on heatsinks, isolated from the chassis.

70 quizmaster

P. Wendt

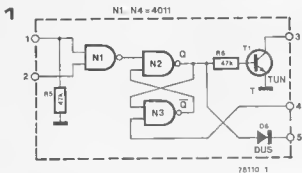

In many quiz games speed of response plays an essential part, the contender who presses a button first getting the first chance of answering a question. The circuit shown here is designed to determine and indicate which contestant is 'quickest on the draw'. The design is modular and may be extended to any number of contestants, and as CMOS ICs are used the circuit can be battery powered, as the only significant current consumption is in the indicator LEDs.

As shown in figure 1 each module basically consists of a set-reset flip-flop N2/N3, with a NAND gate on its set input. Diodes D6 on the Q output of each flip-flop together with N4 in figure 2 form a multi-input NOR gate. So long as every

Q output is low the output of N4 is high, therefore input 2 of N1 in each module is high. When any button is pressed the output of the corresponding N1 goes low and the Q output of the associated flip-flop goes high, turning on T1 and lighting the LED. Via D6 the input of N4 goes high. The output thus goes low, taking the inputs of all N1's low and inhibiting the pushbuttons so that no other flip-flop may be set. The flip-flop which has been set may be reset ready for the next question by pushbutton SR. By connecting additional modules as shown in figure 2 the circuit may be extended almost indefinitely. If desired the output of N4 may be used to drive a buzzer via a buffer transistor.

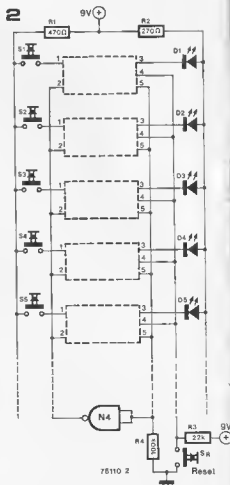

71 DJ killer

R. Vanwersch

It is a sad fact that, nowadays, pop music on the radio is accompanied by the voice of a DJ who, not content with simply introducing records, feels obliged to astound the listener with his wit, pass on the

latest traffic and weather news, recite recipes and endless lists of dedications and a host of other items totally unrelated to the music. The circuit given here, which is designed to 'kill' the sound of the DJ's voice

when records, should prove a boon to those listeners who are only interested in the music. It is possible to distinguish speech

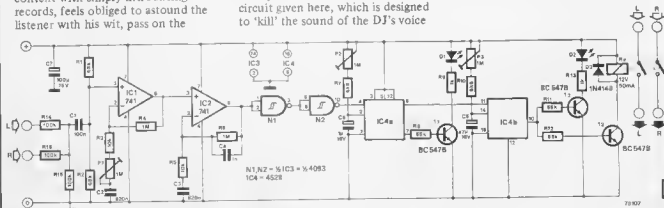

from music by virtue of the fact that distinct pauses occur in speech, whereas music is more or less continuous. The DJ killer detects these pauses and mutes the signal whilst the DJ is speaking.

The left- and right-channel signals are fed into the two inputs of the unit and are summed at the junction of R14, R15 and R16. For use with a mono radio only one input is required. The summed signal is amplified and limited by two high gain amplifiers IC1 and IC2, and is then fed to two cascaded Schmitt triggers, N1 and N2. The output of N2 is used to drive a retriggerable monostable IC4a, the Q output of which is fed to the input of a second retriggerable monostable IC4b.

So long as a continuous signal is present at the input IC4a will be continuously retriggered by the output signal from N2 and its Q output will remain high. The period of IC4a is adjusted, using P2, to be somewhat less than the average duration of a speech pause, so that during such pauses IC4a will reset. This will cause IC4b to be triggered, switching off the signal for a period which is adjustable by P3. LEDs D1 and D2 indicate the output states of IC4a and IC4b and are used to set up the circuit.

To adjust the circuit P2 is first set to minimum resistance. The radio is then tuned to a station which is transmitting speech and P1 is used to adjust the sensitivity until D1 goes

out during pauses. If the sensitivity is set too high then D1 will stay on continuously due to the circuit being triggered by noise, whereas if it is too low then D1 will extinguish during quiet passages of speech. The radio is then tuned to a station which is broadcasting music and P2 is adjusted until D1 stays on continuously. Finally, the radio is tuned to a speech programme and P3 is adjusted until D2 remains permanently lit during speech.

It should of course be noted that the circuit will suppress only a pure speech signal. It will not, for example, suppress the voice of a DJ talking over the music.

CMOS FSK modulator 72

H.W. Braun

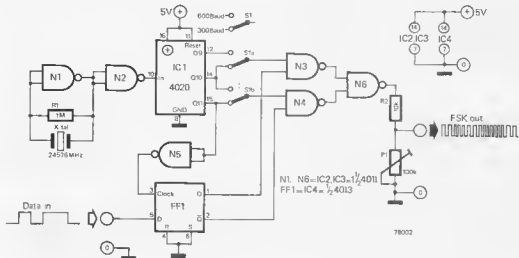

In order to store digital information on a magnetic tape or to transmit it over long-distance (telephone) lines, use is often made of a modulator which converts the digital signal into an FSK (Frequency Shift Keyed) signal. The accompanying figure shows a circuit diagram of a simple and reliable FSK modulator which has the advantage of requiring no calibration.

A crystal oscillator supplies a reference pulse train which is fed to the input of a counter, IC1. At the Q10 output of this counter is a signal with a frequency of approx. 2,400 Hz, whilst a signal with exactly half that frequency, i.e. approx. 1,200 Hz, is available at the Q11 output. Since a crystal oscillator is used, the frequency of both these

signals is extremely stable. Depending upon the logic level of the input signal, one of the above frequencies is fed to the output. Switching between the two frequencies is effected by means of flip-flop FF1, the outputs of which gate N3 and N4. Since the flip-flop is clocked by the 1,200 Hz signal, the FSK signal will always consist of 'complete' cycles of both 1,200 and 2,400 Hz. This arrangement is necessary to facilitate demodulation of the FSK signal.

With switch S1 in the position shown in the diagram, the modulator will output data at a speed of 300 Baud (= bits per second). By changing over the position of this switch a transmitting rate of 600 Baud can be obtained, in which case the

frequencies used then become 2,400 and 4,800 Hz. Since the number of bits per cycle therefore remains the same, the reliability of the modulator is not affected.

The amplitude of the output signal can be varied by means of P1. If the modulator is used with a cassette-recorder, it may prove necessary to include a lowpass filter between the modulator output and the recorder. A simple RC network with a break frequency of roughly 5 kHz should do the trick.

Although it is in fact available, the crystal (2.4576 MHz) may prove difficult to track down, in which case one can, of course, experiment with other crystal values and other counter outputs.

73 | electronic soldering iron

A simple soldering iron regulator for 40 V irons can be constructed using only one opamp, a transistor and a handful of other components. The opamp is used as a comparator. The output from the temperature sensor in the iron is connected to the inverting input and compared with a reference voltage at the non-inverting input, set by P1. When the output from the temperature sensor is lower than the reference voltage, the opamp output is high and transistor T1 is turned on. The relay pulls in

and power is applied to the iron. At a certain point, as the iron heats up, the output from the temperature sensor will exceed the reference voltage causing the opamp output to swing negative, turning off T1. R6 introduces hysteresis to avoid relay 'chatter'. D1 and D2 are included to stabilise the reference voltage.

The calibration procedure is relatively simple. Most temperature sensors used in 40 V irons have a sensitivity of 5 mV/100°C. P1 is

initially set to maximum. When power is applied, the relay will pull in. The output from the temperature sensor can be monitored with a mV-meter, and P2 is then set so that the relay drops out when this voltage reaches 20 mV, corresponding to 400°C. Alternatively, P2 can be set so that the relay drops out soon after the iron has heated up to the point where solder is melted readily.

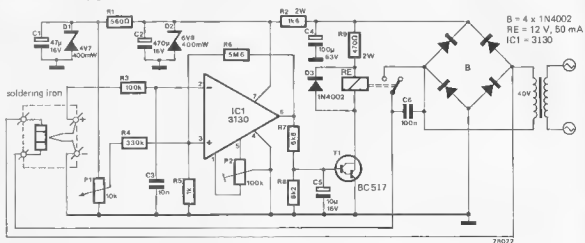

74 | simple video mixer

This video mixer may be used to combine digital video signals (at TTL levels) with line and field sync pulses to provide a composite video signal. The circuit is a little unusual in that it employs a 74 (LS) 125 tri-state buffer IC.

The picture information is fed in via N1 and R2. In the absence of sync pulses the outputs of N2, N3 and N4 are in their high impedance states, so the voltage at the junction of R1 and R2 varies with the video signal between black level and white level. If a line sync pulse (HS) is present at the control input of N2 or a field sync pulse (VS) is present at N3 then the output of N2 or N3 will assume its active state and will go low because the input is grounded. This will pull the voltage at the junction of R1 and R2 down to sync level.

A blanking input is also provided; when this is taken high the output of

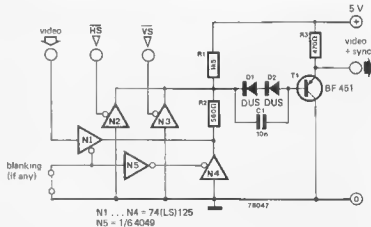

N1 is inhibited whilst the output of N4 goes low, pulling the voltage at the junction of R1 and R2 down to black level. The output of the mixer

is buffered by T1, so that it may be connected direct to a UHF modulator or the video stages of a TV set. (see circuit 28)

76 pseudo random running lamp

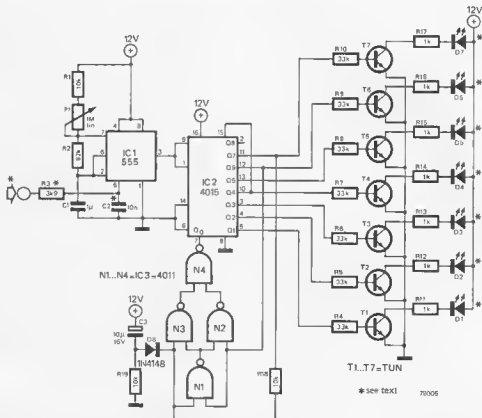

If a number of the outputs of a shift register are fed back in a certain fashion via an EXOR gate to the data input, then the Q outputs of the register will run through the maximum possible number of mutually different logic states (this was explained in detail in the article entitled 'Noise Generator', in *Elektron* 21, January 1977). By using the Q outputs to drive LEDs a visual representation of the truth table for a shift register with EXOR feedback is obtained. At each clock pulse a logic '1' (LED lights up) or '0' moves up one place, so that the net result is

a running light.

In this circuit the Q outputs of the shift register (IC2), which is seven bits long, are routed via an EXOR gate (N1 . . . N4) back to pin 7, the data input, of the register. The clock signal is provided by IC1. The clock frequency, and hence the speed of the running light, can be altered by means of P1. R4 . . . R17 and T1 . . . T7 are included to drive the LEDs. R18, R19, C3 and D8 ensure that when the circuit is switched on, a logic '1' appears at the data input, which means that the register output state can never be all zeroes.

The circuit can be extended for use as a light organ. The LEDs are replaced by opto-couplers which, via the necessary hardware (triac etc.) control incandescent lamps. A rectified version of the audio signal is fed via R3 to the control input of IC1, where it is used to modulate the clock frequency of the register and hence the speed of the running light. Capacitor C2 may then be omitted. Varying the control voltage between 0 and 15 V will result in the clock frequency being varied between 50 and 150% of the value obtained with the control input left floating.

77 0 - 30 V regulated supply

This laboratory power supply offers excellent line and load regulation and an output voltage continuously variable from 0 to 30 V at output currents up to one amp. The output is current limited and protected against output fault conditions such

as reverse voltage or overvoltage applied to the output terminals. The circuit is based on the well-known 723 IC regulator. As readers who have used this IC will know, the minimum output voltage normally obtainable from this IC

is +2 V relative to the V- terminal of the device (which is normally connected to 0 V). The problem can be overcome by connecting the V- pin to a negative potential of at least -2 V, so that the output voltage can swing down to +2 V

relative to this, i.e. to zero volts. To avoid the necessity for a transformer with multiple secondary windings the auxiliary negative supply is obtained using a voltage doubler arrangement comprising C1, C2, D1 and D2 and is stabilised at -4.7 V by R1 and D4. The use of -4.7 V rather than -2 V means that the differential amplifier in the 723 is still operating well within its common-mode range even when the output voltage is zero. The main positive supply voltage is obtained from the transformer via bridge rectifier B1 and reservoir capacitor C3. The supply to the 723 is stabilised at 33 V by D3 to prevent its maximum supply rating being exceeded and a Darlington pair T2/T3 boosts the output current capability to 1 A. The current limit

is continuously variable by means of P3. The output voltage may be adjusted using P2, while preset P1 is used to set zero output voltage. The supply is protected against reverse polarity being applied to the output terminals by D7, and against overvoltages up to 63 V by D6. To set the output voltage to zero P2 is first turned anticlockwise (wiper towards R8) and P1 is then adjusted until the output voltage is zero. With P2 turned fully clockwise the

output voltage should then be approximately 30 V. If, due to component tolerance, the maximum output is less than 30 V the value of R6 may require slight reduction. When constructing the circuit particular care should be taken to ensure that the 0 V rail is of low resistance (heavy gauge wire or wide p.c.b. track) as voltage drops along this line can cause poor regulation and ripple at the output.

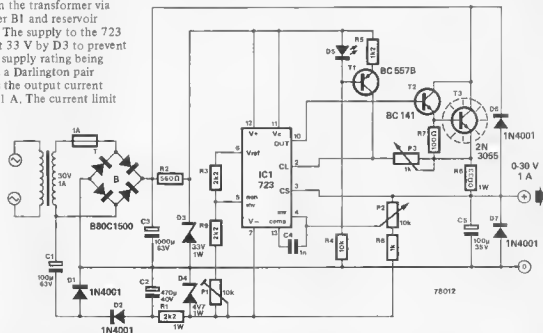

modulatable power supply 78

This DC power supply, whose output voltage can be modulated by an audio-frequency or other LF signal, is intended for such applications as modulation of Gunn-diode oscillators and amplitude modulation of transmitter output stages.

The supply basically consists of an amplifier with a gain of 2, comprising a 741 op-amp and an emitter follower, T2, to boost the output current capability. The DC output voltage of the amplifier may be set between 6 V and 8 V by means of P1, whilst an AC signal may be fed in via C1 to modulate the supply voltage between about 3 V and 10 V. The frequency range of the circuit is approximately 200 Hz to 30 kHz. The off-load current consumption of the supply is around 5 mA and the maximum current that the supply will deliver is about 800 mA at 6 V, provided T2 has an adequate heatsink.

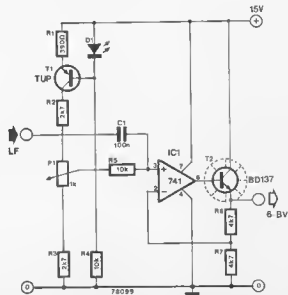

78L voltage regulators | 81

Low-power IC voltage regulators of the 78L series are now so cheap that they represent an economic alternative to simple zener stabilisers. In addition they offer the advantages of better regulation, current limiting/short circuit protection at 100 mA and thermal shutdown in the event of excessive power dissipation. In fact virtually the only way in which these regulators can be damaged is by incorrect polarity or by an excessive input voltage. Regulators in the 78L series up to the 8 V type will withstand input voltages up to about 35 V, whilst the 24 V type will withstand 40 V. Normally, of course, the regulators would not be operated with such a large input-output differential as this would lead to excessive power

dissipation.

A choice of 8 output voltages is offered in the 78L series of regulators, as shown in table 1. The full type number also carries a letter suffix (not shown in table 1) to denote the output voltage tolerance and package type. The AC suffix denotes a voltage tolerance of $\pm 5\%$, whilst the C suffix denotes a tolerance of $\pm 10\%$. The letter H denotes a metal can package, whilst the letter Z denotes a plastic package. Thus a 78L05ACZ would be a 5 V regulator with a 5% tolerance in a plastic package.

All the regulators in the 78L series will deliver a maximum current of 100 mA provided the input-output voltage differential does not exceed 7 V, otherwise excessive power

dissipation will result and the thermal shutdown will operate. This occurs at a dissipation of about 700 mW; however, the metal-can version may dissipate 1.4 W if fitted with a heatsink.

A regulator circuit using the 78L ICs is shown in figure 1, together with the layout of a suitable printed circuit board. The minimum and maximum transformer voltages to obtain the rated output voltage at a current up to 100 mA are given in table 1, together with suitable values for the reservoir capacitor, C1. The capacitance/voltage product of these capacitors is chosen so that any one of them will fit the printed circuit board without difficulty.

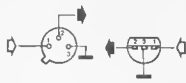
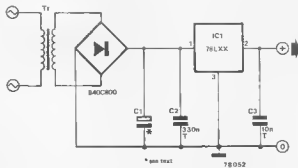
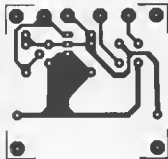
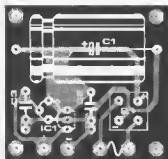

Metal Can Package
bottom view

Plastic Package
bottom view

LM78L06ACH	LM78L08CH	LM78L09ACZ	LM78L09CZ
LM78L08ACH	LM78L08CH	LM78L08ACZ	LM78L08CZ
LM78L10ACH	LM78L10CH	LM78L10ACZ	LM78L10CZ
LM78L12ACH	LM78L12CH	LM78L12ACZ	LM78L12CZ
LM78L15ACH	LM78L15CH	LM78L15ACZ	LM78L15CZ
LM78L18ACH	LM78L18CH	LM78L18ACZ	LM78L18CZ
LM78L24ACH	LM78L24CH	LM78L24ACZ	LM78L24CZ

Table 1

$I_{max.} = 100 \text{ mA}$

U_{out}	type	$U_{tr. (RMS)}$		C1
		min.	max.	
5 V	78L05	6.4 V	9.6 V	1000 μ /16 V
6 V	78L06	7.3 V	10.3 V	1000 μ /16 V
8 V	78L08	9.6 V	12.0 V	470 μ /25 V
10 V	78L10	11.0 V	13.4 V	470 μ /25 V
12 V	78L12	13.1 V	15.2 V	330 μ /25 V
15 V	78L15	15.2 V	17.3 V	330 μ /25 V
18 V	78L18	17.5 V	19.5 V	330 μ /35 V
24 V	78L24	21.9 V	23.7 V	330 μ /35 V

Parts list

Capacitors:

- C1 = see text and table
- C2 = 330 n
- C3 = 10 n

Semiconductors:

- IC = 78LXX (see text and table)
- B = 40 V/800 mA bridge rectifier

82 no - noise preamp

In many applications (audio, measuring systems, aerial amplifiers, communications, etc.) an extremely low-noise preamplifier stage is required, and any design approach that will reduce noise by even 1 dB is greeted with enthusiasm by all concerned.

The circuit shown here is given as a basic design idea - although it is not yet optimal, the results so far are promising. Using even the most sensitive measuring equipment at our disposal we failed to measure any output noise signal at all! However, at present there is still one remaining problem: the gain of the circuit is zero.

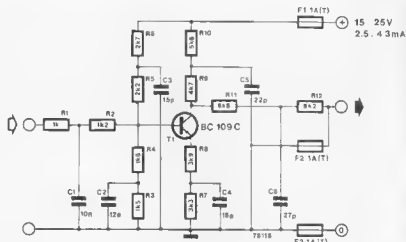

83 timebase scaler

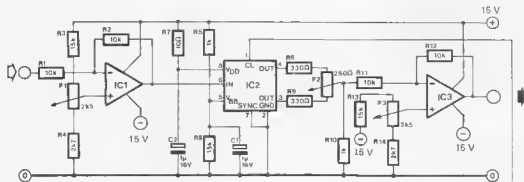

IC1, IC3 = 741
IC2 = SAD 512D (Reticon)
IC4 = N1 ... N4 = 4011

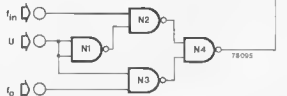

It may on occasion be desirable to display a digital or analogue signal, on an oscilloscope, at a faster or slower rate than is possible with the built-in timebase. What is needed is then what might be called a 'timebase scaler'. The most useful way of doing this is to frequency-scale the input signal, by means of a bucket-brigade (analogue delay line), so that the display fits in nicely with the available sweep speed. This can be achieved by writing a 'chunk' of input signal into the memory 'buckets' at one clock rate, then

reading the same chunk out at a lower or higher rate. The simple circuit shown here will process analogue and digital signals up to 200 kHz. The total write-read cycle should not last longer than 0.1 sec. (at normal temperatures), otherwise too much information will be lost in the leaky buckets, giving an unacceptably attenuated output. The actual bucket brigade (IC2, Reticon type SAD 512) is preceded and followed by DC-level shifters using 741's. If the DC signal component is not of interest, the

level-restorer (IC3) can be omitted and the signal taken out directly through a 100 nF capacitor. When the control voltage U is low, the 'writing' clock frequency f_{in} is fed to the bucket brigade; when U is high the 'read' clock frequency (f_0) is applied. During the write-phase there will in general also be an (unwanted) output signal; it may be desirable to also arrange to suppress the output when U is low. If the circuit is to process a periodic signal, the control voltage should be obtained from a trigger running on

the input signal, otherwise each chunk of output signal will start with a different phase. It will also be necessary to generate a number of write-periods per chunk at least equal to the number of buckets (512), to prevent 'old' information being read out. It is the intention to discuss

these, and other, aspects, in a later edition of *Elektron*.
The circuit given contains three preset potentiometers. Start by setting P1 to bring the output of IC1 to about 5 volts. Then set P2 for minimum clock noise on the output signal. Now slightly readjust P1 to

achieve symmetrical clipping of an excessive signal. Finally set P3 to give the required output DC level, preferably by setting the output to 0 volts with the circuit input shorted to earth.

O. Weumann

DIN cable tester 84

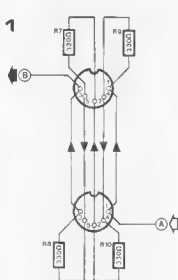

Testing cables fitted with DIN plugs (or any other multi-pin plug) can be a time-consuming affair, since it is possible for any conductor to be open-circuit, or for a short to occur between conductors. The circuit described here will indicate if either of these fault conditions is present. The test jig consists of two 5-pin DIN sockets into which is plugged the cable to be tested. The sockets are fitted with 330 ohm resistors as shown in figure 1 and the test jig is connected between points A and B of the test circuit. This consists of a window comparator comprising

IC1 and IC2. The cable and 330 ohm resistors form a potential divider with P1, which is adjusted so that the voltage at point B is in the middle of the comparator window if the cable is good. The output of IC1 will thus be high, the output of IC2 will be low and D2 will light. If any wire in the cable is open-circuit then the voltage at point B will be zero and the outputs of both ICs will be low, resulting in D1 being lit. If a short occurs between two or more conductors then one or more of the

330 ohm resistors will be shorted out, the voltage at point B will be greater than normal, so the outputs of both ICs will be high and D3 will light.

To set up the circuit a good cable is connected between the two sockets and P1 is adjusted until D2 lights. A 330 ohm resistor is then temporarily connected across one of the resistors mounted on the sockets, when D3 should light. Finally, D1 should light when the cable is unplugged. The circuit may be powered from a 9 V battery or a mains power supply of 9 to 15 V. Current consumption at 9 V is approximately 15 mA.

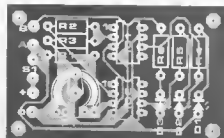
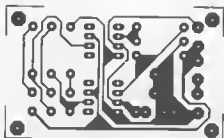
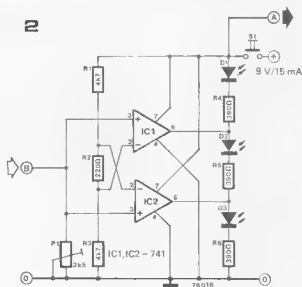

85 data bus buffer

Almost every microprocessor system employs several control signals for the various bus lines (address, data, control buses). The 8080, for example, uses the MEMR and MEMW signals to initiate the read and write cycles. Data and addresses may only be read into or written from system memory during these signals. In the same way the 6800 uses a VMA (Valid Memory Access) signal to validate data on the system buses, whilst the 6502, which is similar to the 6800, also utilises a read/write signal.

The accompanying circuit represents a bi-directional buffer (bus transceiver) which enables unbuffered μP systems to be interfaced with additional memory or peripheral interface adapters. The buffer is suitable for use with the 8080-, 6800- and 6502 systems, for each of which the appropriate connections should be made as shown. The buffer can also be used with other μP systems, however. In the case of the SC/MP, for example, the wiring is the same as that for the 8080. The only point worth noting is that there must be no addressable memory or other interface device between the CPU and the buffer circuit.

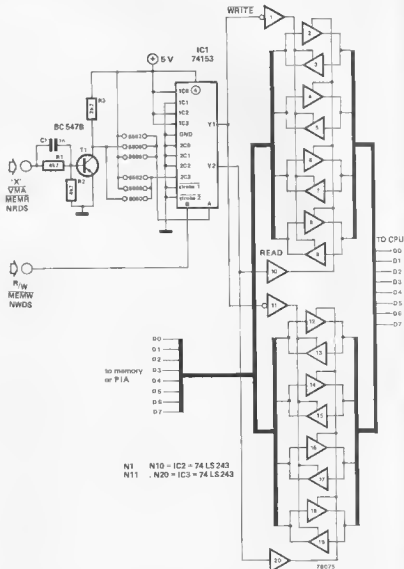

86 data multiplexer

Transmitting data in multiplex form not only reduces the number of transmission lines which are needed, but is also used in LSI ICs in, e.g. time setting circuits in digital clocks, preset circuits for frequency counters, and selecting input data for microprocessors.

The circuit described here is a type of multiplexer which has four data inputs, and by means of the clear- and clock inputs can select one of four nibbles (four bit data word)

present at those inputs.

When the select input of a 74157 is high, the information at the B-input is shifted through to the output. If the select input is low, then the information at the A-input is transferred to the output.

The select inputs of IC2 and IC3 are connected to one another, so that, depending upon the state of the select line, either the two A-inputs or the two B-inputs are shifted through to IC4. Finally, the select input of

IC4 is used to choose between the two remaining nibbles at its A and B inputs.

IC1 is connected as a divide-by-4 counter. When a logic '0' appears at the clear input, the Q outputs of the flip-flops are taken low, with the result that the data at the two A-inputs of IC2 and IC3 are presented to the input of IC4, where, once again, the A-input is selected and shifted to the output, i.e. the nibble set up on S1 is transferred to

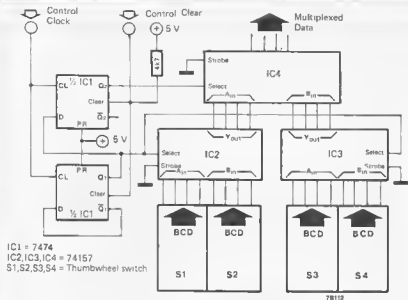

the output. The first clock pulse takes Q1 high, so that the data at the B inputs of IC2 and IC3 is presented to the inputs of IC4. Since the select input of IC4 is still low, the information on S2 is output. The following clock pulse returns Q1 low, but, since the D input of the other flip-flop has just been taken high, Q2 is also high, with the result that the nibble on S3 is available at the output. Finally, the third clock pulse will result in the data on S4 being selected and transferred to the output. Thus, by using one clear pulse and three clock pulses it is possible to multiplex the four data words set up on switches S1 ... S4.

car ammeter 87

A surfeit of circuits has already been published for solid-state car battery voltage monitors. However, no design for a corresponding car ammeter has so far appeared. This design remedies that omission.

Resistor R1 is a shunt across which is a voltage proportional to the current flowing through it (max 133 mV at 40 A). The voltage drop across this shunt is amplified by differential amplifier A1 and used to drive a LED voltmeter comprising A2 to A8. With no current through the shunt, P1 is used to set the output voltage of A1 to nominally 6.5 V, so that the circuit is just on the point of switching over from D4 to D5.

When current is drawn from the battery, the right-hand end of the shunt will be at a lower potential than the left-hand end, so the output of A1 will rise, and the discharge indicating LEDs D5 to D8 will light successively as the current increases. When current flows into the battery, the converse is true, the output of A1 falls, and the charge indicating LEDs D4 to D1 light successively. Of course, variation in battery voltage will also cause the output voltage of A1 to rise and fall, which could give false readings. To overcome this the reference voltage for the LED voltmeter is not fixed but is also taken direct from the battery, so that it rises and falls with the output of A1. This does mean that the calibration of the meter varies slightly with battery voltage, but extreme precision is not a prerequisite for a car ammeter. With the component

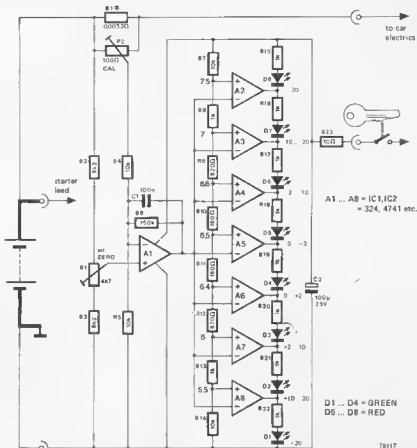

values shown the calibration is nominally correct at a battery voltage of 13 V, but may vary by $\pm 15\%$ if the battery voltage changes between 11 V and 15 V. Several possibilities exist for R1. It can be wound using Manganin or Eureka resistance wire; alternatively the voltage drop along the lead between the battery and regulator

box may be utilised by connecting one end of P2 to the positive battery terminal and the other end to the battery lead at the regulator box. P2 can then be used to calibrate the ammeter. If the voltage drop along the battery lead is insufficient it may be necessary to raise the gain of A1 by increasing the value of R6.

88

AM/FM alignment generator

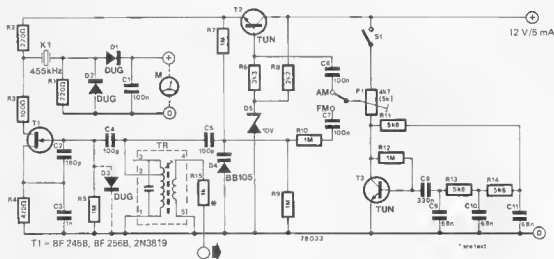

This circuit can be used to align IF strips with a frequency of 455 kHz. The generator produces a 455 kHz signal which, depending upon the position of switches S1 and S2, is either amplitude- or frequency modulated. The actual oscillator is built round FET T1. A conventional IF transformer is used to determine the frequency. The alignment generator is tuned to the correct frequency by passing the output signal through a ceramic IF filter. After rectification the signal can be measured on a voltmeter to ascertain at which setting of the IF transformer coil the amplitude of the signal is greatest. The frequency of the generator

should then coincide with the desired value of 455 kHz.

The circuit is provided with the possibility of AM and FM modulation. When the generator is being aligned, switch S1 should be open, thereby preventing modulation of the output signal. The modulation signal is generated by the low frequency oscillator round T3. Amplitude modulation is realised by modulating the supply voltage of T1 via T2. S2 should then be in the 'AM' position. Frequency modulation (S2 in the 'FM' position) is obtained by means of the varicap diode, D4. In both cases the modulation depth can be varied by the means of P1.

The output signal of the alignment generator is taken from the secondary winding of the IF transformer. Depending upon the desired output voltage and impedance, the series output resistor, R15, can have any value above 100 Ω . In most cases a value of 1 k should prove sufficient.

Parts list

Resistors:

- R1, R2 = 220 Ω
- R3 = 100 Ω
- R4 = 470 Ω
- R5, R7, R9, R10, R12 = 1 M
- R6 = 3k3
- R8 = 2k2
- R11, R13, R14 = 5k6
- P1 = 4k7 (5 k) preset potentiometer

Capacitors:

- C1, C6, C7 = 100 n
- C2 = 180 p
- C3 = 1 n
- C4, C5 = 100 p
- C8 = 330 n
- C9, C10, C11 = 68 n

Semiconductors:

- T1 = BF 245B, BF 256B, 2N3819
- T2, T3 = TUN
- D1, D2, D3 = DUG
- D4 = BB 105
- D5 = zener diode 10 V

Miscellaneous:

- K1 = 455 kHz (Murata) ceramic filter
- Tr = Toko 11100, 12374 IF transformer (or equivalent)

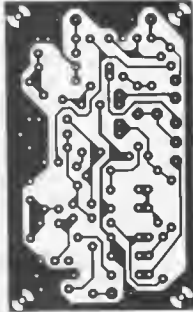
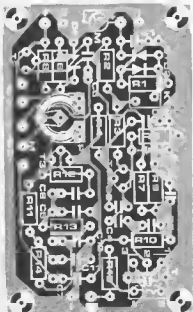

automatic shutter release 89

Only the most expensive cameras have shutter speeds slower than one second. This can be rather inconvenient if long exposures have to be made, since these have to be made by using the 'B' setting and timing the exposure using a watch. The unit described in this article will allow long exposures to be made from one second to 100 seconds, and can be used with any camera that will accept a cable release, and has 'B' shutter setting. It may also be used as a remote shutter release and as a self timer for cameras that do not have this facility.

The mechanical part of the system consists of a 12 V motor (M) geared down to about one revolution per second. The output shaft of the gear train drives a two-lobe cam which actuates a standard camera cable release. When the cable release is actuated a microswitch (S2) is also operated. The gear train can be assembled from standard parts available from most model shops. To keep down the motor speed and prevent it from running on when the power is switched off, friction braking must be provided by a piece of spring steel or piano wire holding a felt pad against the motor shaft. Operation of the circuit is extremely simple. Pressing the start button S1 sets flip-flop N1/N2. Both inputs of N4 are now high, so the output goes low, turning on T1 and T2 and starting the motor. When the lobe of the cam actuates the shutter and microswitch S2, timer IC2 is triggered. The output of IC2 goes

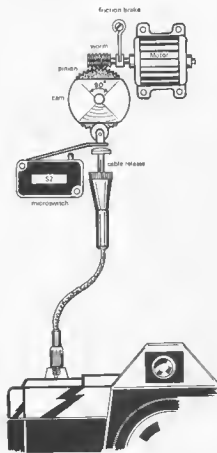

high, the output of N3 goes low and the motor stops. When the timer resets, the motor restarts and turns until the flat of the cam is reached when the shutter is released, S2 switches back to its rest position and flip-flop N1/N2 is reset.

For use as a self timer S3 is switched to its alternative position, and the shutter speed of the camera is set to the required value. When S1 is now pressed IC2 will be triggered immediately, so the motor will not run. When IC2 sets the motor will run and the shutter will operate. The motor will run round until the flat of the cam is reached, when S2 will reset N1/N2.

The unit can also be used as a remote shutter release by fitting a long cable to S1. Normal shutter settings of the camera may be used by setting the delay to minimum, or alternatively the long exposure facility may be used in the normal way with the 'B' setting of the shutter.

Two ranges of long exposure are provided, 1 to 10 s and 10 to 100 s. The unit should be calibrated at 10 seconds and 100 seconds by connecting capacitors in parallel until the correct times are obtained at these two settings. There will be a slight error in the timing due to the time taken for the cam to return to its rest position. However, this will only be significant on the shortest settings, and can be compensated for by arranging the relative positions of the microswitch and cable release so that the switch is actuated slightly before the shutter opens.

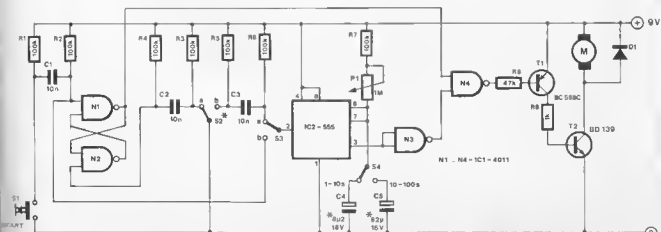

90 bat receiver

Using the following 'bat receiver', it is possible to render ultrasonic signals (i.e. signals whose frequency lies above the audio waveband) audible to the human ear. This type of sound is not only produced by bats, but also by a number of other mammals and insects (butterflies for example!) as well as by a variety of 'inanimate sources' such as gas leaks, jangling a bunch of keys (a possibility for an ultrasonic lock?) etc. The bat receiver works by converting down the frequency of the original ultrasonic signal. The circuit, which is built round the TCA 440 IC, is thus basically a direct-conversion receiver operating in the

25...45 kHz range. An ultrasonic transducer is used as the sensor, a microphone being unsuitable for this type of circuit. The received signal is fed via a simple LC filter (L1/C1) to one of the inputs of the mixer circuit in the IC; the signal is mixed with the output of an astable multivibrator which is also present on the chip. The frequency of the beat frequency oscillator can be varied by means of P1. A lowpass (5 kHz) LC filter is used to retrieve the difference signal of the received- and local oscillator signals. An amplified version of the difference signal is brought out at pin 7 of the IC; T1 is an output buffer for the high impedance

headphones. The feedback loop via D1 and D2 provides the receiver with automatic gain control. The circuit will operate off a supply voltage between 5 and 9 V. On no account should the current consumption exceed 13 mA. The voltage at pin 7 of the IC should be in the region of 1.5 V. Large deviations from this figure will result in the circuit failing to operate satisfactorily. If that is the case, then the value of R6 should be adjusted for the correct voltage at pin 7. The sensitivity of the receiver is determined solely by the type of transducer which is used.

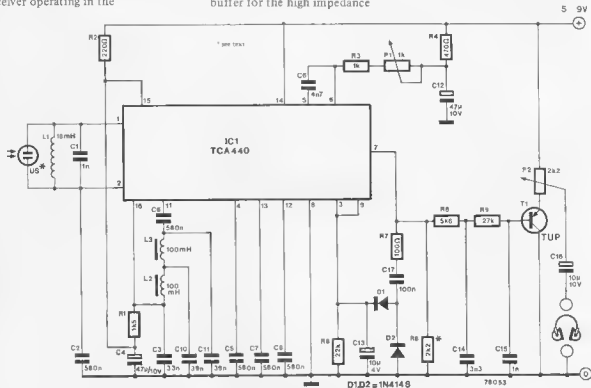

91 model railway lighting

Generally speaking, the internal lighting for model railway carriages is powered direct from the voltage on the rails. However, this voltage is also used to power the locomotive and is varied to control the speed of the train. The result is that the brightness of the lighting varies with the speed of the train, and if the train is actually stopped, then the lighting will be

completely extinguished. It goes without saying that such an arrangement involves a complete loss of realism. However, this problem can be resolved with the aid of the following circuit which ensures an independent supply for the carriage lighting. The circuit utilises the fact that a DC motor will not operate off an

AC supply, and that, furthermore, it has a fairly high impedance if the frequency of the AC voltage is high enough. This means that if a high-frequency AC voltage is superimposed upon the normal (DC) supply voltage for the locomotive, it will have no effect upon the speed of the train, but it can be used to power the carriage lighting. To

ensure that the lighting is supplied solely by the AC voltage, each carriage is DC decoupled by means of a capacitor.

The principle behind the circuit is illustrated in figure 1. The inductor, L, prevents AC voltages from getting back into the DC power supply. Since this coil has to be able to withstand fairly large DC currents, it would be a good idea to use the type of coil employed in loudspeaker crossover filters.

Figure 2 shows the circuit diagram of the circuit used to supply the necessary AC voltage. The circuit actually consists of a sinewave generator followed by an amplifier which can deliver a current of approx. 1.5 A for a maximum output voltage of 10 V RMS, i.e. sufficient to supply roughly 30 lamps. The frequency of the sinewave generator round IC1 is approx. 20 kHz. The gain of IC1 is

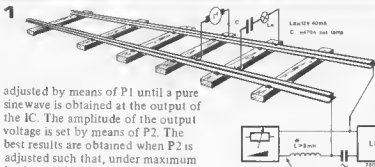

adjusted by means of P1 until a pure sinewave is obtained at the output of the IC. The amplitude of the output voltage is set by means of P2. The best results are obtained when P2 is adjusted such that, under maximum load condition (approx. 30 lamps), the output voltage exhibits minimum distortion. A polyester or polycarbonate (e.g. MKH) capacitor should be used for C7. If the value shown should prove unobtainable in a single capacitor, then several MKH (MKM) capacitors can be connected in parallel. Since they cannot withstand large AC currents, the use of bipolar electrolytics is unsatisfactory. For every carriage lamp a series



capacitance of about $0.5 \mu\text{s}$ is required. Thus, if the carriage lighting consists of two lamps, then the capacitor in series with these two lamps should have a value of approx. $1 \mu\text{F}$. Again, the use of MKH or MKM capacitors is recommended. Finally, it should be noted that the output of the circuit is short-circuit proof, and that transistors T1 and T2 should be provided with heat sinks.

2

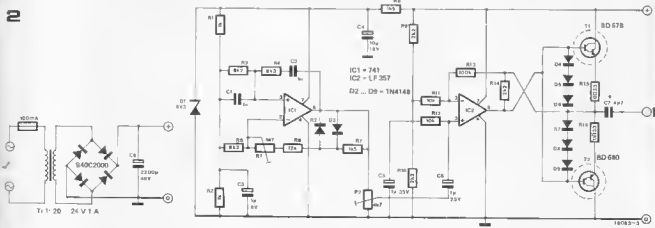

bandwidth limited video mixer 92

When using digital circuits such as character generators to display information on a TV screen the digital signals frequently have a bandwidth greater than that of the i.f. and video stages of the TV set. This can cause degradation of picture quality and it therefore makes sense to limit the bandwidth of the video signal.

A simple way to do this is to stretch the video pulses using the simple circuit shown. This uses two Schmitt triggers and an RC network to delay the signal, which is then OR'd with the undelayed signal by N3, N4 and N5. The output pulses from N5 are thus longer than the original pulses, which has the effect of reducing the video bandwidth by about a third without losing character definition.

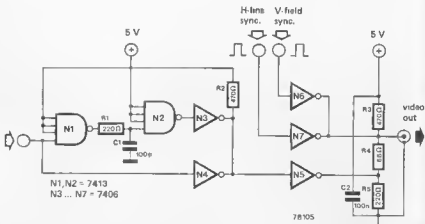

Two of the remaining gates in a 7406 hex inverter IC can be used to build a video mixer which allows picture information and sync signals to be combined into a composite

video signal.

Note that this circuit can only be used with digital video signals (black or white content only) and not with analogue signals having grey tones.

93 FM IF strip

When used in conjunction with an FM front end, the following circuit for an IF strip will form a handy pocket FM receiver. The heart of the circuit is the TDA 1190Z IC, which contains an IF limiter/amplifier, a lowpass filter, an FM detector and audio amplifier to drive a loudspeaker. The IC also contains a regulated power supply for the IF and detector stages. The detector is a so-called coincidence detector. The IC was originally intended to be used in the audio stage of a TV receiver, however it can be employed quite satisfactorily with the higher FM-IF of 10.7 MHz. By using the accompanying p.c.b. there should be no problem in constructing a miniature FM receiver. A prototype model produced the following results: output power 1 W (for a supply voltage of 12 V and feeding into a 12 Ω load); AM suppression of at least 50 dB for input voltages between 0.1 and 20 mV (AM modulation depth 30%, modulation frequency 1 kHz, FM modulation 40 kHz). An input voltage of 50 μ V was needed for a signal-to-noise ratio of 26 dB. Compared with other IF amplifier/detector ICs, the performance of TDA 1190Z is not unfavourable. The quiescent current consumption of the circuit (i.e. with no output signal) is only 15 mA. With one or two minor alterations the circuit can be employed with an IF of 455 kHz, as is used in e.g. two-metre receivers.

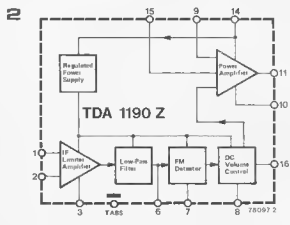
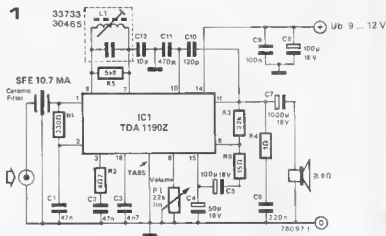

Parts list		Semiconductors:
Resistors:	Capacitors:	IC1 = TDA 1190Z (Motorola)
R1 = 330 Ω	C1, C2 = 47 n	
R2 = 4.7 k	C3 = 4 n	Miscellaneous:
R3 = 22 k	C4 = 50 μ /16 V	FL1 = ceramic filter SFE 10.7 MA,
R4 = 1 Ω	C5, C6 = 100 μ /16 V	CFS 10,7 A or equivalent
R5 = 5k6	C7 = 1000 μ /16 V	L1 = detector coil Toko 33733,
R6 = 15 Ω	C8 = 100 n	30465
P1 = potentiometer 22 k (25 k) linear	C9 = 100 n	
	C10 = 120 p	
	C11 = 470 p	
	C12 = 10 p	

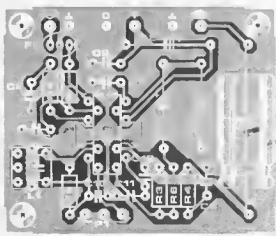
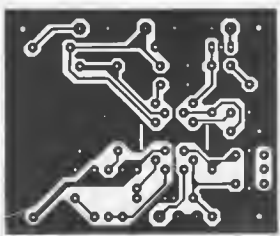

brake efficiency meter 94

The braking efficiency of a car can be found simply by measuring the time taken to bring the car to a halt from a known velocity. The deceleration in feet per second² is then found from the equation:

$$a = -\frac{v}{t}$$

where v is the velocity in feet per second and t is the time, in seconds, taken to halt the car. This can be converted into 'g' by dividing by the factor 32. On a sound road surface in dry conditions, a car with good brakes and tyres should be able to manage a deceleration in excess of 0.5 g.

It is a simple matter to build a timer which is started by an inertia switch when deceleration begins and is stopped when the car halts.

However, this time then has to be converted into a deceleration figure by using the above equation. An instrument which reads out the deceleration directly would be much more preferable. The difficulty is to find some measurable quantity which is directly proportional to the deceleration.

If deceleration from a standard velocity of say 30 m.p.h. is plotted against time taken for the car to stop, the curve is obviously a rectangular hyperbola, the time to stop increasing as the deceleration power of the car worsens. If a charged capacitor is discharged through a resistor then the voltage across the capacitor will of course fall exponentially with time. By

arranging for the time constant to be different over different portions of the discharge curve a reasonable approximation to a hyperbola can be obtained. If the capacitor is discharged during the deceleration period the voltage remaining on the capacitor at the end of this time will be almost directly proportional to the deceleration. This is illustrated in figure 1.

Figure 2 shows a practical circuit for a brake efficiency meter. When the reset button is pressed the outputs of flip-flops N1/N2 and N3/N4 go low, C1 is charged to about 5.1 V via T1, and T2 is turned off. The car is driven along a level road at 30 m.p.h. (48 km/h). The brakes are then applied and the inertia switch changes over, triggering both flip-flops, turning off T1 and turning on T2. C1 now discharges until the car stops, when the inertia switch changes back again, resetting flip-flop N3/N4 and turning off T2.

1

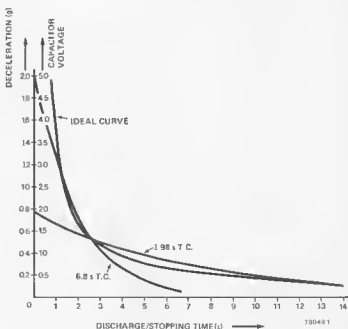

Due to the two diodes in series with P1 and R3, C1 will discharge down to about 1.2 V with a time constant of approx. 2 seconds. Below this voltage D2 and D3 do not conduct and the time constant increases to about 7 seconds. Over the range of about 1.4 to 14 seconds, which corresponds to a deceleration range of 1 g to 0.1 g, the discharge curve is a reasonable approximation to an hyperbola, so the voltage remaining on C1 is proportional to the deceleration. This voltage may be measured with a conventional voltmeter or a LED voltmeter such as the UAA 170.

The inertia switch can be a lever microswitch with a weight attached to the lever, a mercury tilt switch, or

any other suitable arrangement that will operate whenever the car brakes. To calibrate the circuit, P2 is set to its mid-position, the inertia switch is closed manually and P1 is adjusted until it takes 2.75 seconds for a reading of 0.5 g (1.25 V) to be reached. The procedure is repeated and P2 is adjusted until it takes 13.75 seconds for a reading of 0.1 g to be reached.

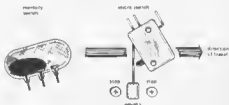

2

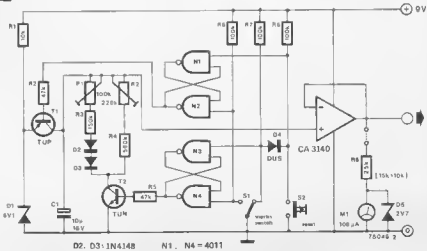

95 frequency synthesiser controller

In transceivers the desired frequency is often dialled into a frequency synthesiser by means of thumbwheel switches. This type of switch is not particularly cheap, so the alternative proposed here is worth considering. This circuit has the added advantage that a new frequency can be selected by means of two push-buttons which can be mounted next to the push-to-talk button on the microphone – a useful feature, particularly for mobile use.

The basic principle of a frequency synthesiser is fairly straightforward. The output frequency of a voltage controlled oscillator (VCO) is divided by a presettable number. The result is compared with a fixed reference frequency, and some type of control system (usually a PLL) adjusts the frequency of the VCO so that the result of the division has the same frequency as the reference. The net result is that the output of the VCO is equal to the reference frequency multiplied by the division ratio, so that it can be easily and accurately tuned in a succession of fixed steps by altering this division ratio.

In the circuit described here, the VCO output (f_{VCO}) is divided by IC3, IC4 and IC5. These counters are set in the decimal down-count mode. Each time they reach zero (000) the carry-out pulse of IC5 is fed through N10 to the preset-enable inputs of these three ICs. IC3 and IC4 are then preset to the decimal number determined by two further divide-by-ten counters, IC1 and IC2, and IC5 is preset to 1111. The same pulse is fed to one input of the PLL, where it is compared with the reference frequency. The output frequency of the pulses from N10 must therefore be equal to the reference frequency and, since the VCO output is used to clock the counters, the output frequency of the VCO must therefore be equal to the reference frequency multiplied by a number '9XY', where X and Y are the 'preset' values stored in IC2 and IC1 respectively. As an example, if the reference frequency is 1 kHz the tuning range will be from 900 to 999 kHz in 1 kHz steps. If the preset number in IC1 is 4 and the number in IC2 is 6, the output frequency in

this case will be 964 kHz. If IC1 and IC2 were thumbwheel switches, the circuit would be fairly conventional. However, they aren't. As noted earlier, these ICs are decimal counters and they will only 'store' a number as long as they do not receive count pulses. S1 and S2 are used to set up the required count, S1 causing them to count up and S2 resulting in count-down. If either of these buttons is pressed briefly, the count will change by one. However, if the button is held down the count will continue to change in the direction determined by the choice of pushbutton (S1 increasing the count and S2 decreasing it), whereby the rate at which new values occur increases if the button is held down for any length of time. Starting from the pushbuttons, this part of the circuit operates as follows. N6 and N7 suppress contact bounce for S1; similarly N8 and N9 clean up the output from S2. When either of the buttons is operated the corresponding output (from N6 or N8) goes low, so the output of N5 goes high and N3 is enabled. This

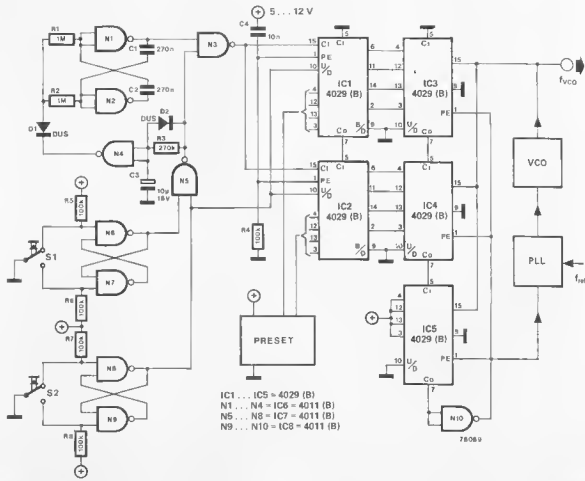

gate will now pass the output of the voltage-controlled squarewave generator, consisting of N1 and N2, to the clock inputs of IC1 and IC2. The clock frequency from N1 and N2 depends on the output state of N4. If this output is high the clock frequency is low and vice versa. Initially, C3 is discharged, the output of N4 is high, and the clock frequency is low. However, if a pushbutton is held down the output of N5 will remain high, charging C3 through R3. After a short time C3

will have charged sufficiently for the output of N4 to change state and the clock frequency will increase. As soon as the button is released C3 will discharge rapidly through D2 and N5. When S1 is operated, the output of N6 is low and the output of N8 is high, so IC1 and IC2 are in the up-count mode. When S2 is operated, the output of N6 is high but the output of N8 is low; this output state switches both counters into the down-count mode. Both IC1 and IC2 can be preset at

initial switch-on of the circuit. To this end C4 and R4 are included; these components enable the preset inputs of these counters briefly when power is first applied. Any desired initial setting can be programmed (in BCD) by connecting the preset inputs of IC1 and IC2 to positive supply or supply common. This possibility is symbolised in the circuit by the rectangle labelled 'preset'.

limiter/compressor

96

The circuit shows an application of Cadac's V-Cat or Voltage Controlled Attenuator as a Limiter/Compressor control element.

In operation P1 sets the input to the circuit. P3 adjusts the threshold at which gain control commences for both limiting and compression. P4 sets the point at which limiting only will commence to allow for two slope control, where the limiting circuit cuts in after compression of an increasing input has started. P5 sets the attack time on both compression and limiting and P6 adjusts the time for the circuit to recover after an overload. P2 sets the rate of compression of the audio path. At the minimum resistance end the circuit will compress a change of about 20 dB at the input into a 4 dB change at the output while at the other end of the pot, the ratio is more like 2:1 (20 dB to 10 dB). When limiting starts, the ratio of

input change to output change starts at about 5:1 at maximum slope control resistance, going to about 40:1 at minimum resistance. P7 controls the threshold at which an external audio input starts to control the main chain's attenuation and may be connected to the input if inverse limiting is required. With this connection an input increasing over the threshold will produce a falling output level resulting in some fairly bizarre effects on programme. Apart from the V-Cat card itself, no particularly unusual components are used. A Harris 46 05-5 Quad IC was used with the prototype to allow the full ± 22 Volt rail capability of the V-Cat to be used. However, if ± 15 volt supplies are to be used and a limited clip level can be tolerated, then any Quad 741-type of IC can form the DC control blocks required. Another prototype functions almost equally well using an LM324 so the

design is tolerant of IC type. The basic specification of the circuit is as follows:
 Signal input: up to +24 dBm
 Signal output: up to +24 dBm
 Threshold: from -20 dBm
 Attack time: 100 μ s to 500 msec
 Release time: 500 ms to 5 sec
 Input impedance: 10 k - 100 k depending on input control position.
 Output load: 47 k
 (A Unity gain buffer should be incorporated to drive line loads.)
 Frequency response: 10 Hz to 100 kHz ± 1 dB.
 Distortion: less than 0.1% at any frequency 40 Hz to 10 kHz from no limiting to full limit and 1 second release time.
 Output noise: less than 25 μ V, 10 Hz to 10 kHz bandwidth.
 Supplies: ± 22 V (Can be used on ± 15 V without modification but dynamic range suffers.)
 (Cadac V-Cat Application note)

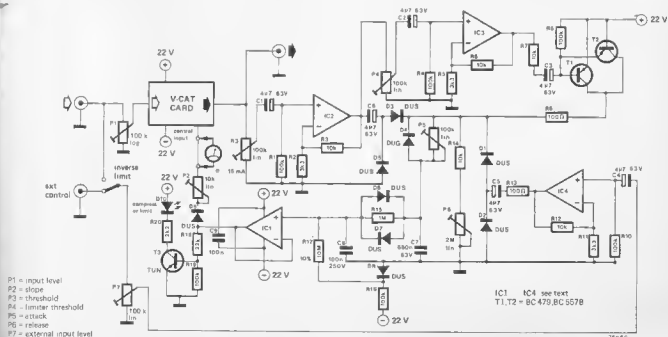

97 programmable address decoder

This circuit can prove useful when experimenting with microprocessor systems. It will recognise a preset 16-bit address from a maximum of 64 k of memory. The address of the data byte which is to be checked is set up on switches S1 and S2. As soon as the desired address appears on the address bus, the output of the circuit goes high. An inverted (active low) version of the output signal is also available.

If desired, sections of the circuit can be used to decode pages of a certain size. If, for example, IC1 and IC2 are omitted, then the circuit will address memory blocks of 1/4 k.

It should be noted that, because of the fairly high fan-in of IC1...IC4, the circuit can only be used in conjunction with systems which have a buffered address bus unless low-power Schottky types (74LS85) are used.

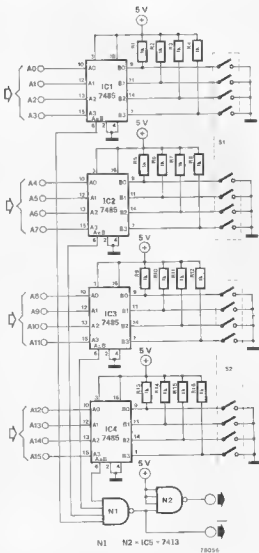

98 squarewave oscillator

Using almost any operational amplifier it is possible to build a simple and reliable squarewave oscillator. The design is free from latch-up problems sometimes experienced with conventional multivibrators, the frequency is independent of supply voltage and the circuit uses only six components. Operation of the circuit is as follows: at switch-on C1 is discharged. The inverting input of IC1 is thus at zero volts while the non-inverting input is held positive by R1 and R2. The output of IC1 therefore swings

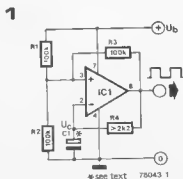

positive, so that the non-inverting input is held at about 2/3 supply voltage by R1, R2 and R3. C1 now charges from the output of IC1 via R4 until the voltage across it exceeds the voltage at the non-inverting input, when the output of IC1 swings down to about zero volts. The exact positive- and negative-going output swing achieved depends on the type of op-amp used. The non-inverting input of IC1 is now at 1/3 supply voltage. C1 now discharges through R4 into the output of IC1 until its voltage

falls below that on the non-inverting input, when the output of IC1 again swings positive and the cycle repeats. Since variations in supply voltage equally affect the charging of C1 and the threshold levels at which the op-amp output changes state, these two effects cancel and the oscillation frequency is independent of supply voltage.

The frequency of oscillation is given

$$f = \frac{1}{(1.4) R_4 C_1}$$

where f is in Hertz

R_4 is in Ohms

C_1 is in Farads

Alternatively, if R_4 is in kilohms and C_1 is in microfarads then f will be in kilohertz.

Practically any op-amp may be used in this circuit and table 1 lists several popular op-amps, together with the supply voltage range over which each may be used and the maximum

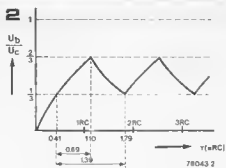

Table 1.

Op-amp	lowest supply voltage	highest supply voltage	highest frequency
709	5 V	36 V	325 kHz
741	3.5 V	36 V	100 kHz (triangular output above 30 kHz due to slew-rate limiting)
CA3130	3 V	16 V	275 kHz
CA3140	5 V	36 V	200 kHz
CA3150	8.5 V	36 V	275 kHz
LF357	3 V	36 V	325 kHz
LM301	3 V	36 V	325 kHz

oscillation frequency which is typically obtainable. The duty-cycle of the squarewave should be 50%, but due to slight asymmetry in the output stages of the op-amps this will not be the case. The only op-amp amongst those listed which will give a duty-cycle of exactly 50% is the CA 3130. At low supply voltages it may also be found that the frequency changes with supply voltage due to variations in the output characteristics of the op-amps. However, with supply voltages greater than 10 V this should not be a problem.

The working voltage of C_1 must be at least 2/3 of the supply voltage.

temperature-compensated reference voltage 99

The popular 723 IC regulator has an on-chip reference voltage with a fairly low temperature coefficient. By using a simple gimmick the 723 can be used as an 'oven' to maintain itself (and hence the reference voltage) at a virtually constant temperature, thus practically eliminating the temperature dependence of the reference voltage. The 723 is connected as a unity-gain non-inverting amplifier, to whose input is fed a voltage

$$\frac{U_{ref} \times R_4}{R_3 + R_4}$$

This causes a current to flow through load resistor R_5 via T_1 and T_2 , the output transistors of the 723. The power dissipated in these transistors causes the chip temperature to rise. The temperature of the current sense transistor, T_3 , which is on the chip, also rises, with the result that its base-emitter voltage falls. When it falls below the value set by P_1 then T_3 will turn on, cutting off the output current until the chip temperature has fallen sufficiently for T_3 to turn off again.

The result is that the chip, and hence the reference voltage, is held at a virtually constant temperature. Obviously the chip temperature must be maintained considerably higher than ambient for correct operation (since the circuit cannot cool the chip to a temperature below ambient)

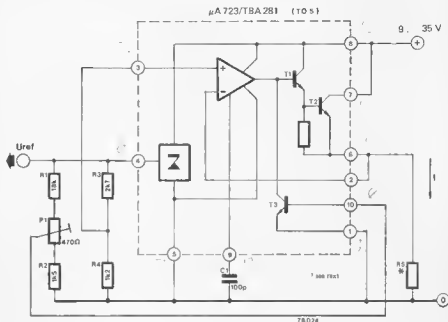

and P_1 is provided to adjust the chip temperature. P_1 should be adjusted until the case temperature of the IC is between 60 and 70°C, i.e. just bearable to the touch. The adjustment procedure may take some time as it will be necessary to allow the chip temperature to stabilise after each adjustment of P_1 . The best

procedure is to turn the wiper of P_1 towards R_1 , switch on and allow to stabilise, measure the temperature, readjust P_1 , allow to stabilise etc. The value of R_5 is dependent on the supply voltage used and should be 33 ohms for voltages between 9 V and 15 V, 68 ohms for 15 V to 25 V and 100 ohms for 25 V to 35 V.

100 touch dimmer

The novel feature of this lamp dimmer is that the circuit is totally solid-state and uses no mechanical switches nor potentiometers. The lamp can be switched on and off and faded up and down simply by placing a finger on a touch plate.

The heart of the circuit is a Siemens S566B IC. This IC is basically a triac phase-controller, i.e. the lamp brightness is controlled by varying the point in the mains cycle at which the triac triggers, as shown in figure 1. The sooner the triac is triggered the greater the conduction angle of the triac and the more power is delivered to the lamp. The later that the triac triggers the less power is delivered. Varying the conduction angle of the

triac from 30° to 150° gives control from almost full power down to almost zero.

Figure 2 shows how the S566B varies the triac conduction angle in response to finger contact with the touch plate. Touching the plate briefly (60 to 400 ms) switches the lamp on at the brightness it was set to when last used. Touching the plate briefly a second time switches the lamp off.

If the plate is touched for longer than 400 ms the lamp will come on and then start to fade up and down as the IC periodically increases and decreases the conduction angle. When the finger is removed from the touch plate the lamp will stay at whatever brightness it has reached. The complete circuit of a touch dimmer using the S566B is shown in figure 3. This also shows alternative possibilities for controlling the circuit, such as replacing the touch plate by a pushbutton or using multiple touch contacts.

(Siemens application)

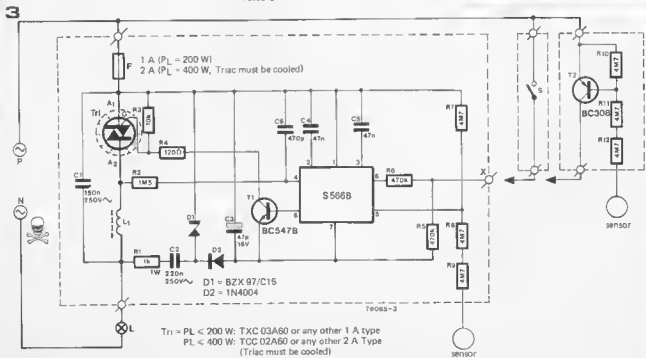
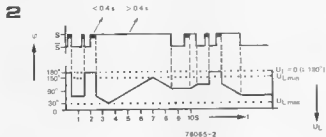
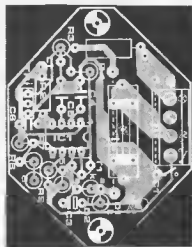
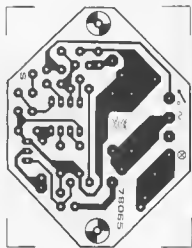

Tri = PL < 200 W: TXC 03A60 or any other 1 A type
PL < 400 W: TCC 02A60 or any other 2 A type
(Triac must be cooled)

L1 = Toroid choke coil, 50 . . . 100 μH

hexadecimal display 101

H.H. Arends

When working with microprocessors hexadecimal notation is frequently used to enter and read out data. Hexadecimal digits can be decoded and displayed in a number of ways. The first method is to use a commercial HEX display with built-in decoder, such as the Hewlett-Packard 5082-7340. However, these devices are fairly expensive. The second approach is to programme a display routine into the microprocessor. However, this must be stored in a ROM and occupies approximately 200 bytes of memory, depending on the microprocessor type.

The method described here uses a normal BCD to seven-segment decoder-driver to decode digits 0 to 9 in the conventional manner, whilst digits A to F are taken care of by a dual 1-of-4 decoder and a simple diode decoding matrix. This approach is considerably less expensive than commercial HEX decoders and does not require memory space nor a special ROM, which is the case with the software method.

The circuit of the HEX decoder is given in figure 1. To decode digits 0 to 9 a 7448 decoder is used with a common-cathode LED display instead of the more usual 7447 and common-anode display. This is to allow a wired-OR function between the outputs of the 7448 and the outputs of the 74155, which decodes A to F. The 7448 has active-high outputs. This means that when a particular segment of the display is not lit the relevant output transistor of the 7448 is turned on, shorting out the segment. When a segment is lit the output transistor of the 7448 is turned off, so current flows through the display segment via one of the series resistors R1 to R8. Digits 0 to 9 are decoded in the usual manner by the 7448. Gates N1 and N2 perform the Boolean function $F = (B + C)D$. As can be seen from the truth table the output of N2 is high for digits 0 to 9. This inhibits the 74155, so that all outputs of the 7407 buffers are turned off.

For digits A to F the output of N2 is low. This activates the lamp test input of the 7448 so that all outputs are switched off. This would result in all segments of the display being lit, but the 74155 is now active. Outputs 2 to 7 go low in turn for digits A to F, and via a diode matrix shown in figure 2 these outputs are used to

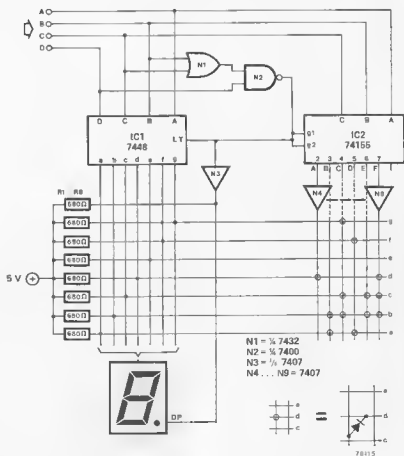

Table 1

	D	C	B	A	F	output 74155						
	2	3	4	5	6	7						
0	0	0	0	0	1	1	1	1	1	1	1	1
1	0	0	0	1	1	1	1	1	1	1	1	1
2	0	0	1	0	1	1	1	1	1	1	1	1
3	0	0	1	1	1	1	1	1	1	1	1	1
4	0	1	0	0	1	1	1	1	1	1	1	1
5	0	1	0	1	1	1	1	1	1	1	1	1
6	0	1	1	0	1	1	1	1	1	1	1	1
7	0	1	1	1	1	1	1	1	1	1	1	1
8	1	0	0	0	1	1	1	1	1	1	1	1
9	1	0	0	1	1	1	1	1	1	1	1	1
A	1	0	1	0	0	1	1	1	1	1	1	1
8	1	0	1	1	0	1	0	1	1	1	1	1
C	1	1	0	0	0	1	1	0	1	1	1	1
D	1	1	0	1	0	1	1	1	0	1	1	1
E	1	1	1	0	0	1	1	1	0	1	1	1
F	1	1	1	1	0	1	1	1	1	1	1	0

short out the segments that are not required in each character. One small disadvantage of this circuit is that, since the 7448 decodes a 6 without lighting segment 'a', the 6 is indistinguishable from b. To overcome this problem the decimal point of the display is lit for digits 0 to 9 and extinguished for A to F.

References

1. Kartalopoulos, S.V. 'Display letters and symbols on a seven-segment display'. Electronic design 25, December 6th 1976, page 108.
2. Wesselhoeft, U. 'Mikrocomputer daten und adressen schrittweise angezeigt'. Mikroprozessoren hardware, p-p 139/140.
3. Kampschulte, H. Experimenting with the SC/MP. Elektor 34, February 1978, p-p 228-238.

102 slide-tape synchroniser

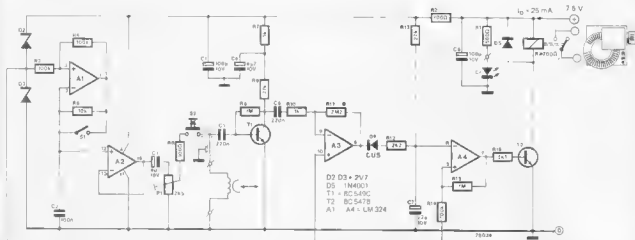

This circuit can be used with tape recorders which have an audio-visual (AV) socket for synchronisation of a slide show with a recorded commentary. AV tape recorders are equipped with an extra head which is used to record a synchronisation signal on a separate track from the audio signal. On playback this sync signal is used to control the automatic slide projector. If the tape recorder is equipped with an AV socket but not with sync signal generator and detector circuits then a separate slide synchroniser is required.

A 1 kHz oscillator built around A1 provides the sync signal as long as S1 is open. When a slide change is required pushbutton S2 is pressed and the signal is led out to be recorded on the tape. On playback the recorded signal is picked up by the record/playback head and amplified by T1 and A3. C7 is normally charged via R13, so the output of the Schmitt trigger built around A4 is low, T2 is turned off and the relay contacts are open. When a sync signal is present C7 discharges through D4 and R12 due to the output of A3 going alternately high and low. The output of A4 goes high, T2 turns on, the relay contacts close and the slide is changed. During playback S1 should be closed to prevent signals inadvertently being recorded on the tape should S2 accidentally be pressed.

Since the control signal fed to the slide projector must be of the correct duration for reliable operation the projector should be hooked up to the sync unit whilst recording the commentary to check this. The projector will then be controlled by the signal which is being recorded. P1 is used to vary the level of the recorded signal. It may be found

that, due to the high gain of T1 and A3, the circuit is triggered by tape noise. In this case the value of R11 should be reduced to, say, 1 M and P1 should then be adjusted until an adequate signal level is recorded on the tape.

If the AV socket of the tape recorder

has a 7.5 V DC output, as some models have, then the circuit may be powered from this. Otherwise, a mains power supply must be used

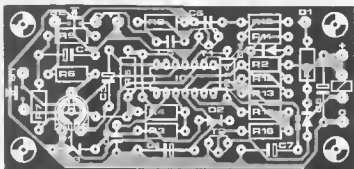
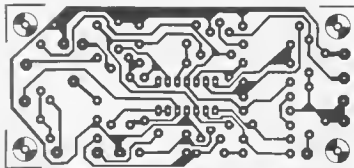

Parts list

Resistors:

R1 = 560 Ω
 R2, R6 = 100 Ω
 R3, R4, R14 = 100 k
 R5 = 10 k
 R7, R10 = 1 k
 R8, R15 = 1 M
 R9 = 27 k
 R11 = 1 M ... 2M2
 R12 = 2k2 (see text)
 R13 = 22 k
 R16 = 2k7

Capacitors:

C1, C8 = 100 μ /10 V
 C3 = 4 μ 7/10 V
 C4 = 4 μ 7/6 V
 C7 = 22 μ /10 V
 C2 = 100 n
 C5, C6 = 220 n

Semiconductors:

D1 = LED
 D2, D3 = 2V7
 D4 = DUS

D5 = 1N4001

T1 = BC549C

T2 = BC547B

A1 ... A4 = LM 324

Miscellaneous:

S1 = on/off switch

S2 = pushbutton switch

Relay = 6 V,

coil resistance

greater than 700 Ω

frequency synthesiser 103

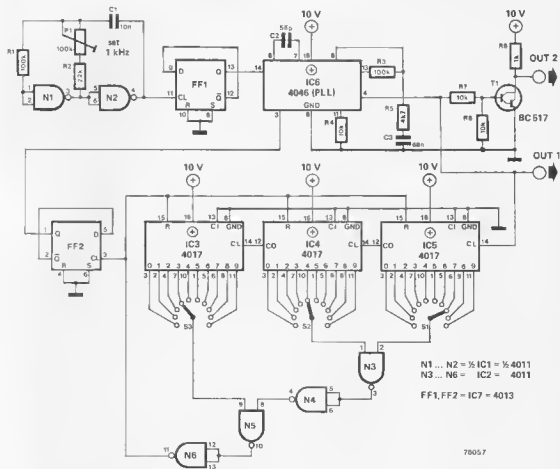

78057

The output frequency of this squarewave generator can be programmed in 1 kHz steps from 1 kHz to 999 kHz. The heart of the circuit is a 4046 CMOS phase-locked loop which has an extremely wide capture range.

The output of a 1 kHz clock generator, N1/N2, is divided down by FF1 to give a symmetrical 500 Hz squarewave output, which is fed to one of the phase comparator inputs of the 4046 (IC6). The Voltage Controlled Oscillator (VCO) output

of IC6 is fed to the second input of the phase comparator via a programmable frequency divider (IC3-IC5) and FF2.

The VCO output frequency of the PLL adjusts itself until the output of FF2 has the same frequency and phase as the clock output from FF1. If the division ratio set on switches S1 to S3 is n then the VCO frequency must obviously be n times the 1 kHz clock frequency. Setting a number n on switches S1 to S3 therefore gives an output

frequency of n kHz. The VCO output from pin 4 may be used to drive CMOS circuits direct, however, for other applications a transistor buffer may be required.

If greater frequency accuracy is required then the clock oscillator may be replaced by a more stable 1 kHz reference frequency such as the divide-by- 10^3 output of the IC counter timebase described elsewhere in this issue.

many hands make light work 104

H. Gohlisch

This simple circuit can be used as a party trick which should completely flummox anyone who has little knowledge of electronics. At first

sight the circuit appears to consist of two switches and two lamps connected in series, with a power supply connected across the whole

chain. When both switches are closed both lamps light, as would be expected. However, when one switch is opened only one of the lamps is

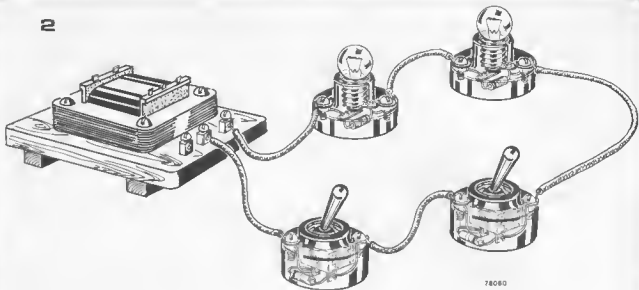

extinguished. If the other switch is opened then the second lamp goes out, whilst both switches must be open to extinguish both lamps. Furthermore, if either lamp is removed from its holder the other lamp, if lit, will remain lit. The circuit (figure 1) is extremely simple, consisting only of a transformer and four diodes in addition to the lamps and switches. When S1 and S2 are both open then D4 is reverse-biased on the positive half-cycle of the mains waveform, whilst D3 is reverse-biased on the negative half-cycle, so no current can flow in either direction. If S1 is closed then D3 is shorted out and current can flow anticlockwise round the loop (during the negative half-cycle) through D4, D2 and L1, lighting L1. A small current also flows through L2 due to the forward voltage of D2, but not enough to light it. If S2 is closed then D4 is shorted out and current can flow clockwise round the loop through D3, D1 and L2. When both switches are closed then both lamps light.

1

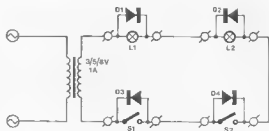

D1, D4—1N4001
L1, L2—6V/0.3A

Figure 2 shows a suggested layout for the circuit, which should be mounted on a board with the connecting wire clearly visible so that there can be no suspicion of skulduggery. If batten-mounting MES lampholders are used then diodes D1 and D2 can be concealed in their bases, and if surface-mounting toggle switches are used diodes D3 and D4 can be concealed inside them. A variation on this construction is to mount D1 and D2 inside the screw bases of the lamps, though this calls for a little care in dismantling the

lamps without damaging them. If either lamp is then unscrewed the other lamp will extinguish, further confirming the illusion that the circuit is simply a series connection. Furthermore, if the lamps are changed over then L2 will still be controlled by S1 and L1 by S2, even though they are now in different sockets. As the circuit may be used by children the accent should be on safety, with a double-bobbin transformer such as a bell transformer being used.

105 LED X-Y plotter

The steady fall in the price of LEDs now makes it an economic proposition to construct an X-Y display using a LED matrix. Two UAA 170 ICs are used to drive a 10 x 10 matrix of LEDs. Since the UAA 170 is normally intended to drive 16 LEDs arranged in a 4 x 4 matrix, the outputs of the UAA 170s must first be decoded to give a 1 of 10 output,

using transistors T1 to T10 and T11 to T30.

A voltage applied to IC2 (U_y) will drive the vertical axis of the display, whilst a voltage applied to IC1 (U_x) will drive the horizontal axis of the display. At any time one LED in the display will be lit at the intersection of the row and column outputs which are active at that time. As the

circuit stands the input voltage range is +0.25 to +2.5 V which is set by P1 and P2. However, the upper limit can be increased by the use of attenuators on the inputs. Low frequency AC signals may be displayed as Lissajous figures by AC coupling the inputs and DC biasing pin 11 of each IC such that the centre LEDs of the display light with

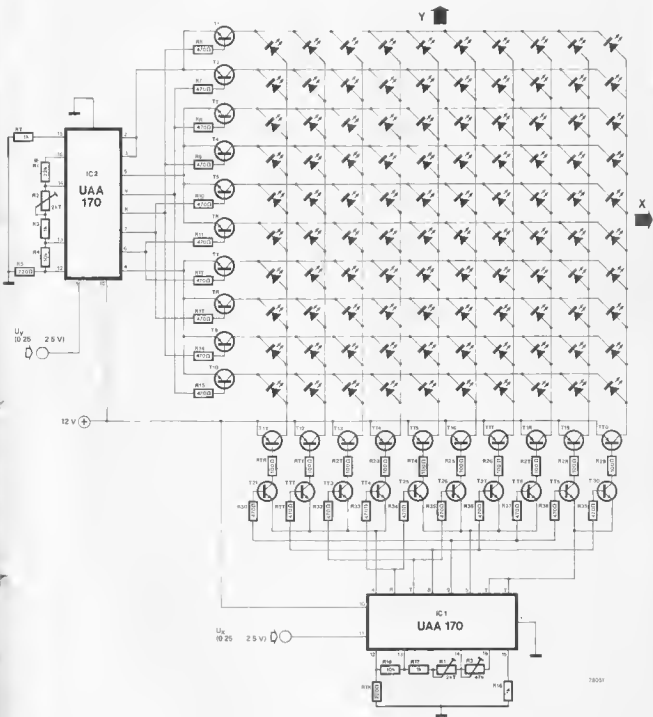

T1 T10 = TUN
 T11 T20 = TUP
 T21 T30 = TUN

* See text

no input signal. By feeding a sawtooth waveform into the X input and a signal into the Y input the display may also be used as a simple low-frequency oscilloscope (maximum input frequency 1 kHz).

Literature:
 Siemens 'Bauteile Report' 6/77, *Elektron* No 12, April 1976 p. 441 'LED meters'.

Editorial note: tests show that the maximum input frequency quoted is

optimistic, 50 Hz being nearer the truth. At higher frequencies display 'splash' occurs (this can be reduced by using faster transistors), and display brightness suffers (this can be improved by reducing the value of R1 to 2k2).

market

Communications receivers

Redifon Telecommunications have just released a complete new range of versatile communications receivers designed to fulfill all operational requirements whether they be land-based, naval or mercantile marine. Designated the R1000 Series, these high-grade receivers provide fast, continuous, frequency synthesis tuning over the range 15 kHz to 30 MHz and offer full remote control capability.

Using a single rotary control, the receivers can be tuned in either direction at a fast or slow rate. An associated push button electromechanically disengages the tuning control and locks the receiver. Readout of frequency down to 10 Hz is provided by a seven figure LED display.

An important feature of the R1000 Series is its 20-channel memory store. This permits the frequency, service and bandwidth data for up to nineteen operational channels to be stored for rapid recall, reducing operator fatigue and improving efficiency. The remaining channel is dedicated to power-off conditions, so that in the event of power failure to the receiver the operational status information is automatically stored in the memory and recalled on power restoration.



Of interest in many applications is the scanning facility, which permits scanning of any of the channels held in store. Either of two groups of up to nine channels can be scanned, with channel dwell times adjustable between 0.1 and 15 seconds.

The outstanding performance of the R1000 Series under all operating conditions is largely due to the a.g.c. system employed,

providing exceptional dynamic range and excellent blocking and cross modulation characteristics. The receiver input circuits are fully protected against strong signals from adjacent transmitters. The extended and remote control facilities permit a high degree of system flexibility. Full duplication of all receiver controls and displays, including tuning and ancillary functions such as selection of antenna, are provided for the remote operator. Moreover up to sixteen receivers can be controlled in this way from a single control unit, and an indication of the receiver selected provided.

The marine version of the R1000 Series has received UK type approval to MPT 1201 and is designed to meet other European specifications.

Redifon Telecommunications Ltd, Broomhill Road Wandsworth, London SW18 4JQ, England

(771 M)

SOS COSMOS RAMS

New from RCA Solid State, the MWS5101D and CDP1822D are 256-word x 4-bit static random-access semiconductor memories fabricated using silicon-on-sapphire (SOS) technology for applications where a combination of high speed, low power and simplicity of use is required. The memories have separate data inputs and data outputs, and utilise a single power supply of 4.5... 5.5 V for the MWS5101D and 4.5... 10.5 V for the CDP1822D.

Two chip-select inputs are provided to simplify system expansion. An output-disable control provides wired-OR capability and is also useful in common input/output systems. The read/write input or output-disable input allows these random-access memories to be used in common data input/output systems by forcing the output into a high-impedance state during a write operation,

irrespective of the chip-select input conditions. After valid data appear at the output, the address inputs may be changed immediately. These output data will be valid until either the output-disable input or the chip-select input is high, or the new data of the next memory cycle are applied.

The silicon-on-sapphire C-MOS technology used in the memories is characterised by its immunity to relatively high noise levels — up to 20% of the drive voltage. For TTL interfacing at 5 V operation, excellent system noise margin is preserved by using a pull-up resistor at each input. Memory retention is provided for a minimum standby battery voltage of 2 V, and a 3-state data output is available for bus-oriented systems. The MWS5101D and CDP1822D are supplied in 22-lead hermetic dual-in-line side-brazed ceramic packages.

RCA Solid State, Sunbury-On-Thames, Middlesex, TW16 7HW, England

(764 M)

Alphanumeric

Monsanto has announced a new 8-character alphanumeric display that is expected to have wide use in the computer terminal industry. The new display, designated MAN 2815, consists of eight 3.43 mm, red characters. Each character is a 14-segment display, capable of presenting all alphabetical and numeric symbols, as well as 26 additional characters that would be of use in the presentation of intelligent information.

The new unit features very low power consumption, as low as 0.5 mA forward current, or 1.0 mW per segment. This low power feature makes the unit easily compatible with microprocessors and related circuitry. The average luminous intensity per segment is 100 microcandelas, typical, and 60 microcandelas, minimum, at a forward current of 2.5 mA. In addition, the intensity is controlled, segment-to-segment and character-to-character within a module to a ratio of 2 to 1. The

units are internally wired for multiplexing. Physically, the unit measures 35.3 mm, end-to-end, with a character spacing of 4.45 mm. This allows as many as 32 characters in a 142.2 mm panel space, since the modules are stackable end-to-end. The MAN 2815 digits are capable of a peak forward current per segment of 250 mA, maximum, and an average forward current per segment of 10 mA maximum. Maximum average power dissipation for the total package is 1200 mW at an ambient temperature of 50°C. Applications for the MAN 2815 display system are expected in computer terminals, test and measurement equipment, desk top calculators, automotive instrumentation, communication message centres, and verification systems.

Monsanto Limited, 10-18 Victoria Street, London SW1H 0NQ, England

(774 M)

PA IC

RCA Solid State has introduced a new integrated circuit audio power amplifier, the CA2002, specifically designed for applications in automotive radio and other mobile radio systems. The 8W class B amplifier, which uses RCA's hermetic Gold-CHIP encapsulation, is designed for driving loads as low as 1.6 Ω. The CA2002 provides a high output current capability (up to 3.5 A), very low harmonic and crossover distortion, and load-dump voltage-surge protection. Output short-circuit and thermal overload protection are also incorporated.

The circuit is supplied in a 5-lead plastic TO-220 style (Versa V) package. All leads (except ground) are electrically insulated from the mounting flange, eliminating the need for insulating hardware.

RCA Solid State, Sunbury-on-Thames, Middlesex, TW16 7HW, England

(768 M)



market

DPM

Verospeed have introduced a range of LED and LCD Digital Panel Meters and Count Display Modules.

A 3½ Digit DPM Module is available with both LCD and LED displays. The four Digit Count Display Module has a 0.43 inch Red LED display and features reset zero and display latches, muted zero suppression and multiplexed BCD outputs. An add-on module is also available to

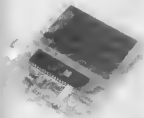

convert this module into a digital frequency meter with ranges 0-9.999 kHz and 0-99.99 KHz. The six digit counter module has many features which makes it one of the most powerful Count/Display Systems available. Besides normal up/down counting from input pulses, the module may also be loaded from external comparator output. An 'equals' output is produced when the contents of the counter and the register are equal. Thumbwheel switches with BCD outputs can be used to set levels in both cases.

Verospeed, Barton Park Industrial Estate, Fastleigh, Hampshire, SO5 5RR England.

(835 M)

Miniature bridge

Micro Electronics Ltd. has introduced a miniature 1.5 A bridge-phase bridge rectifier, the 'Handy' Series, designed for printed-circuit mounting without heat sinking. The circular wire-ended



bridge measures only 9.5 mm in diameter and 7.1 mm in depth, with a minimum lead length of 28 mm.

Versions are available with repetitive peak reverse voltage ratings from 50 V to 800 V, nonrepetitive peak reverse voltage ratings of 100-1000 V, and sinusoidal rms input voltage from 35 to 560 V. Average d.c. output current is 1.5 A, and peak surge current for one cycle at 50 Hz is 50 A.

Maximum forward voltage drop per diode is 1.1 V at 1 A, and maximum reverse current is 10 µA. Operating and storage temperature range is -50°C to +150°C.

Micro Electronics Ltd., York House, Empire Way, Wembley, Middlesex, England.

(838 M)

Desoldering tools

Lee Green Precision Industries are now offering a new range of precision made, economically priced, Desoldering Tools. The first one to be released is the 'Handy' type which is only 150 mm long making it very easy to handle by women and has obvious advantages for continuous fast flow production lines.

An easily operated hand plunger produces maximum suction and minimum backstroke. All metal construction makes these tools virtually indestructible; replaceable teflon nozzles are available and as all the 'O' ring

seals are standard sizes, they are easy to replace. Each tool is available in a selection of colours: red, gold, black or white.

One of the major advantages is the low re-coil which eliminates solder being thrown back down the nozzle after it has been sucked up.

A typical 10 off price would be £ 5.96 each.

Lee Green Precision Industrie Ltd., Grotes Place, Blackheath, London, SE3 0RA England.

(834 M)

Keyboards

A complete new keyboard family from Grayhill, inc. offers choice of 12 button or 16 button arrays plus choice of circuitry, mounting means, and legending. Circuitry options include matrix coding,

single pole/common bus switching, 2 out of 7 code or 2 out of 8 code. Either the 3x4 or 4x4 array is available with post mounting or screw type flange mount. Both styles are adaptable to front panel or sub-panel mounting. Additionally, the post mounted version can be specified with .55" or .750" button centers. Legend choices include standard keyboard arrangements with milled-in legend, hot-stamped legends to customer order, and snap-on caps for self-legending of prototypes. A legend sheet to assist in completing prototypes is available.

Each of these variations incorporates a dome type contact system which provides excellent audio and tactile feedback to the operator. The contact system has been tested for over 3,000,000 operations per button and is readily interfaced with logic circuitry with standard buffering techniques. The keyboard housing and buttons are molded of durable ABS plastic to withstand stringent use and environmental conditions. The design incorporates recessed buttons to prevent accidental actuation and to avoid contact with more than one button at a time.

Price is dependent upon the number of buttons, button centers, type of mounting, and circuitry.

Grayhill, inc., 561 Hillgrove Avenue, La Grange, Illinois, USA.

(829 M)

