

**ES7**  
may 1978  
**ELECTOR**  
up-to-date electronics for lab and leisure

DM 5,50  
U.S.A./CAN. \$1,50

satellite antenna  
digital reverberation  
mini shortwave  
receiver

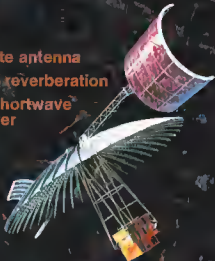

Author  
Editor  
Printer  
Folio  
German  
English  
ISSN  
Subscription

*Sounds by*  
**ELEKTOR**  
**1977 ISSUES**

In 1977 we published over 200 different designs in Elektor which included approx. 29 Audio articles, 6 Car articles, 18 Design ideas, 18 Domestic circuits, 10 Fun, games and model building Circuits, 18 Information articles . . . . . microprocessors . . . . . 13 music circuits, . . . . . 12 Paranormal circuits . . . . . 13 Power supply circuits, 17 R.F. circuits, 37 Test and Measuring Equipment circuits, 7 Time, Timers and counters, circuits, and 11 miscellaneous designs . . . . .

Due to our increased circulation and popularity of these articles, only limited amounts of 1977 back issues are available so please order your set of issues 21-32, while our stocks last (issues 29,30 & 31 already sold out) we would hate to disappoint you . . . . .

A more detailed cumulative index for 1977 is published in the December 1977 issue number 32. A list of available printed circuit boards and their prices can be found in the EPS list at the front of this issue

To order these, please refer to 'Elektor readers service order form' in this issue



**please don't  
 leave your  
 issues of  
 elektor  
 just  
 lying  
 about**

a professionally produced magazine deserves to be well kept, so keep your elektors in a binder. order your 1978 binder now. available from elektor publishers Ltd.

These smart green binders will keep your copies of Elektor clean and tidy. Each issue is easily removed for reference.



**PRICE**  
**£2.30**  
 (incl. p&p)  
 U.S.A. and Canada \$4.00

To order these, please refer to 'Elektor readers service order form' in this issue

# elektor 37 decoder

Volume 4

Number 5

Editor : W. van der Horst  
 Deputy editor : P. Holmes  
 Technical editors : J. Barendrecht, G.H.K. Dam,  
 E. Krepelsauer, G.H. Nachbar  
 A. Nachtmann, K.S.M. Walraven

Subscriptions : Mrs. A. van Meyel

International head offices: Elektor Publishers Ltd.  
 Bourgognestr. 13a  
 Beek (L), Netherlands  
 Tel. 04402-4200  
 Talax: 56617 Elakt NL

U.K. editorial offices, administration and advertising:  
 Elektor Publishers Ltd., Elektor House,  
 10 Longport Street, Canterbury CT1 1PE, Kent, U.K.  
 Tel.: Canterbury (0227)54430. Telex: 965504.  
 Please make all cheques payable to Elektor Publishers Ltd.  
 at the above address.

- Bank: 1. Midland Bank Ltd., Canterbury, A/C no. 11014587  
 Sorting code 40-16-11, Giro no. 3154254.  
 2. U.S.A. only: Bank of America, c/o World Way  
 Postal Center, P.O. Box 80689, Los Angeles,  
 CA 90080, A/C no. 12350 04207.  
 3. Canada only: The Royal Bank of Canada,  
 c/o Lockbox 1969, Postal Station A, Toronto,  
 Ontario, M5W 1W9, A/C no. 160-269-7.

Assistant Manager and Advertising : R.G. Knapp  
 Editorial : T. Emmens

ELEKTOR IS PUBLISHED MONTHLY on the third Friday of each month.

- U.K. and all countries except the U.S.A. and Canada:  
 Cover price £ 0.50.  
 Number 39/40 (July/August), is a double issue,  
 'Summer Circuits', price £ 1.—.  
 Single copies (incl. back issues) are available by post from our  
 Canterbury office, at £ 0.60 (surface mail) or £ 0.95 (air mail).  
 Subscriptions for 1978, January to December incl.,  
 £ 6.75 (surface mail) or £ 12.00 (air mail).
- For the U.S.A. and Canada:  
 Cover price \$ 1.50.  
 Number 39/40 (July/August), is a double issue,  
 'Summer Circuits', price \$ 3.—.  
 Single copies (incl. back issues) \$ 1.50 (surface mail) or  
 \$ 2.25 (air mail).  
 Subscriptions for 1978, January to December incl.,  
 \$ 18.— (surface mail) or \$ 27.— (air mail).  
 All prices include post & packing.

CHANGE OF ADDRESS. Please allow at least six weeks for change of address. Include your old address, enclosing, if possible, an address label from a recent issue.

LETTERS SHOULD BE ADDRESSED TO the department concerned: TO = Technical Queries; ADV = Advertisements; SUB = Subscriptions, AOM = Administration; ED = Editorial (articles submitted for publication etc.); EPS = Elektor printed circuit board service.

For technical queries, please enclose a stamped, addressed envelope or a self-addressed envelope plus an IRC.

THE CIRCUITS PUBLISHED ARE FOR domestic use only. The submission of designs or articles to Elektor implies permission to the publishers to alter and translate the text and design, and to use the contents in other Elektor publications and activities. The publishers cannot guarantee to return any material submitted to them. All drawings, photographs, printed circuit boards and articles published in Elektor are copyright and may not be reproduced or imitated in whole or part without prior written permission of the publishers.

PATENT PROTECTION MAY EXIST in respect of circuits, devices, components etc. described in this magazine. The publishers do not accept responsibility for failing to identify such patent or other protection.

NATIONAL ADVERTISING RATES for the English language edition of Elektor and/or international advertising rates for advertising at the same time in the English, Dutch and German issues are available on request.

DISTRIBUTION IN U.K.: Spotlight Magazine Distributors Ltd., Spotlight House 1, Bantwell Road, Holloway, London N7 7AX.

DISTRIBUTION IN CANADA: Gordon and Gotch (Can.) Ltd., 55 York Street, Toronto, Ontario, M5J 1S4.

Copyright © 1978 Elektor publishers Ltd — Canterbury.

Printed in the Netherlands.

What is a TUN?  
 What is 10 n?  
 What is the EPS service?  
 What is the TC service?  
 What is a missing link?

#### Semiconductor types

Very often, a large number of equivalent semiconductor exist with different type numbers. For this reason, 'abbreviated' type numbers are used in Elektor wherever possible

• '741' stand for  $\mu$ A741, LM741, MC641, MIC741, RM741, SN72741, etc.  
 • 'TUP' or 'TUN' (Transistor, Universal, PNP or NPN respectively) stand for any low frequency silicon transistor that meets the following specifications:

UCEO, max	20V
IC, max	100 mA
I <sub>fe</sub> , min	100
Prot, max	100 mW
f <sub>T</sub> , min	100 MHz

Some 'TUN's are BC107, BC108 and BC109 families; 2N3856A, 2N3859, 2N3860, 2N3904, 2N3947, 2N4124. Some 'TUP's are BC177 and BC178 families. BC179 family with the possible exception of BC159 and BC179, 2N4122, 2N3251, 2N3906, 2N4126, 2N4291.

• 'DUS' or 'DUG' (Diode Unvarsal, Silicon or Germanium respectively) stands for any diode that meets the following specifications:

	DUS	DUG
UR, max	25V	20V
IF, max	100mA	35mA
IR, max	1 $\mu$ A	100 $\mu$ A
Prot, max	250mW	250mW
CD, max	5pF	10pF

Some 'DUS's are BA127, BA217, BA218, BA221, BA222, BA317, BA318, BA31X, BA561, 1N914, 1N4148.

Some 'DUG's are OA85, OA91, OA95, AA116.

• 'BC107B', 'BC237B', 'BC547B' all refer to the same 'family' of almost identical better-quality silicon transistors. In general, any other member of the same family can be used instead.

BC107 (-8, -9) families.  
 BC107 (-8, 9), BC147 (-8, 9),  
 BC207 (-8, 9), BC237 (-8, 9),  
 BC317 (-8, -9), BC347 (-8, -9),  
 BC547 (-8, -9), BC171 (-2, -3),  
 BC182 (-3, -4), BC382 (-3, -4),  
 BC437 (-8, -9), BC414

BC177 (-8, 9) families  
 BC177 (-8, 9), BC157 (-8, 9),  
 BC204 (-5, -6), BC307 (-8, -9),  
 BC320 (-1, -2), BC350 (-1, -2),  
 BC557 (-8, 9), BC251 (-2, -3),  
 BC212 (-3, -4), BC512 (-3, -4),  
 BC261 (-2, -3), BC416

Resistor and capacitor values  
 When giving component values, decimal points and large numbers

of zeros are avoided wherever possible. The decimal points are usually replaced by one of the following abbreviations:

p (pico-) =  $10^{-12}$   
 n (nano-) =  $10^{-9}$   
 $\mu$  (micro-) =  $10^{-6}$   
 m (milli-) =  $10^{-3}$   
 k (kilo-) =  $10^3$   
 M (mega-) =  $10^6$   
 G (giga-) =  $10^9$

A few examples  
 Resistance value 2k7 2700  $\Omega$   
 Resistance value 470 470  $\Omega$   
 Capacitance value 4p7 4.7 pF, or 0.000 000 000 004 7 F  
 Capacitance value 10n this is the international way of writing 10,000 pF or 0.01  $\mu$ F, since 1 n is  $10^{-9}$  farads or 100 pF.  
 Resistors are  $\frac{1}{2}$  Watt 5% carbon types, unless otherwise specified. The DC working voltage of capacitors (other than electrolytic) is normally assumed to be at least 60 V. As a rule of thumb, a safe value is usually approximately twice the DC supply voltage.

#### Test voltages

The DC test voltages shown are measured with a 20 k $\Omega$ /V instrument, unless otherwise specified.

#### U, not V

The international letter symbol 'U' for voltage is often used instead of the ambiguous 'V'. 'V' is normally reserved for 'Volts'. For instance  $U_B = 10$  V, not  $V_B = 10$  V.

#### Maing voltages

No mains (power line) voltages are listed in Elektor circuits. It is assumed that our readers know what voltage is standard in their part of the world! Readers in countries that use 60 Hz should note that Elektor circuits are designed for 50 Hz operation. This will not normally be a problem; however, in cases where the mains frequency is used for synchronisation some modification may be required.

#### Technical services to readers

• **EPS service** Many Elektor articles include a lay-out for a printed circuit board. Some — but not all — of these boards are available ready-etched and predrilled. The 'EPS print service list' in the current issue always gives a complete list of available boards.  
 • **Technical queries** Members of the technical staff are available to answer technical queries (relating to articles published in Elektor) by telephone on Mondays from 14.00 to 16.30. Letters with technical queries should be addressed to Dept. TD. Please enclose a stamped, self-addressed envelope; readers outside U.K. please enclose an IRC instead of stamps.

• **Missing link** Any important modifications to, additions to, improvements on or corrections in Elektor circuits are generally listed under the heading 'Missing Link' at the earliest opportunity



Artificial reverberation is an extremely useful sound effect which can be used to compensate for the small dimensions of most listening rooms by using a delay line to increase the proportion of 'reflected' sound heard by the listener. Of the many different methods of constructing a delay unit, the digital reverberation unit is the most advanced.

p 5-08



Although hardly quite 'fitting' for the accolade of 'state-of-the-art', the mini short-wave receiver, which employs a single tuned circuit and a regenerative detector, boasts a number of attractive features.

p 5-17



By comparatively simple means it is possible to extend a circuit which generates a monochrome video signal so as to add the extra dimension of colour. The colour modulator can be used with, for example, a monochrome TV games circuit to provide a composite colour video signal which can be fed direct to any UHF modulator.

p 5-28



The ever increasing use of satellites for tele communications purposes has focused considerable interest on the problem of designing suitable aerial systems for the reception of these extremely high frequency transmissions. This month, some of the more commonly employed types of receiver aerials are discussed and in particular a newly developed system, the so-called 'Vokurka aerial'.

# contents

selector	5-01
aerial systems for satellite communication	5-04
digital reverberation unit	5-08
mini short wave receiver	5-17
selector	5-20
TV scope ring buffer to enable memory	
<b>voice (2) — C. Chapman</b>	<b>5-21</b>
The first part of this article provides a general overview of the basic principles of speech synthesis and coding. The second part makes a more detailed look at the various features of a speech synthesizer such as the 'free blank' words, a word detector and a word length limiter. The third part of the article discusses the various methods of speech synthesis which are available.	
missing link	5-26
input signal preamp (electromechanical)	
perceptron switch	5-28
Designing the perceptron switch which can automatically provide an output signal which is either 'on' or 'off' for any of the 16 possible combinations of the 4 input signals. The perceptron switch which can be used in any of the 16 possible combinations of the 4 input signals. The perceptron switch which can be used in any of the 16 possible combinations of the 4 input signals.	
colour modulator	5-28
circuit boards and soldering	5-34
If you are a beginner in the world of electronics, you will have found it hard to find a good book to read. In the last few years of my career, I have found a number of books which are well worth reading. These books are: 'The Art of Electronics' by Horowitz and Hill, 'The Art of Electronics' by Horowitz and Hill, 'The Art of Electronics' by Horowitz and Hill.	
universal logic tester — J. Sargant	5-38
The logic tester can be used to test logic ICs and CMOS ICs. It is well suited to other basic test kits which include a logic chip tester. It is designed to provide a high level of logic test. It includes a built-in logic test and a built-in logic test.	
market	5-39
advertisers index	UK 26

# The choice is yours

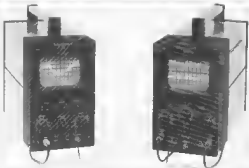

Prices as Feb 78

D61a. £190 plus VAT and Nominal Delivery Charge

D61b. £220 plus VAT and Nominal Delivery Charge

When it comes to deciding on a general purpose oscilloscope for the laboratory or the service department, you have a choice between a single or dual trace model and medium or high bandwidth.

Tekquipment's D61a is an excellent instrument for the service bench, particularly for TV work when dual trace 10MHz bandwidth and special triggering features are needed.

For less demanding applications, the single trace 6MHz S61 will make most of your routine measurements.

You will get the same Tekquipment reliability and Tekquipment value - whatever your choice.

**TELEQUIPMENT** <img alt="Tekquipment logo: a circle containing a stylized 'T' and 'E' with a horizontal line through them." data-bbox="630 878 710 902"/>

Teknika UK Ltd, P.O. Box 65, Coltham Lane, Harpenden, Herts.  
Tel. 06827 62141 Telex 21668

# selektor

improvement in sound localisation is obtained, particularly for side and rear images.

Q-Biphonic recordings can be made using two dummy-heads instead of one, where the signals from the front head feed the front loudspeaker pair and the signals from the rear head feed the rear pair. In other words, the recording is made using four ears (the obvious solution to the two-ear-four-loudspeaker paradox?!).

A Q-Biphonic processor has also been developed, offering multi-mike and pan-potting facilities.

It is perhaps interesting to note that JVC are also the originators of the CD-4 quadrophonic system. Since the Q-Biphonic system offers distinctly better image localisation than conventional Pair-Wise Mix, and since the Q-Biphonic system requires four transmission channels which can be accommodated on a CD-4 disc, it seems reasonable to assume that JVC have exactly that in mind!

*Victor Company of Japan Ltd.,  
European liaison office,  
Kiesstraße 20,  
6 Frankfurt/M. 90, W-Germany*

(309 S)

## Soundfield microphone: a new way to record

The Calrec Sound Field Microphone Type CM4050 caused quite a stir among professional recording engineers when it was presented at the recent AES Convention in Hamburg. Developed primarily for the Ambisonics Surround Sound System, it gives unprecedented operational flexibility in 'conventional' stereo recording as well.

The microphone is used in conjunction with a special equalisation unit, and provides four output signals: the soundfield pressure (equivalent to the output of an omnidirectional mono microphone) and three 'velocity' outputs. The

latter outputs correspond to the three components of the pressure gradient in the sound field: left minus right, front minus back and up minus down. Together, these four signals correspond to the Ambisonics B-Format signals. Also, together they completely define the sound field present at the microphone - and this is where things begin to get interesting!

In order to visualise the exceptional capabilities inherent in this system, it may be helpful to imagine the following experiment. It has been stated that the B-Format signals completely define the sound field present at the microphone. If these B-Format signals are recorded and then played back at a later date through the same microphone (assuming that were possible!) the result would be to exactly recreate the original sound field at that point in space. Any conventional microphone could now be placed in this field, pointing in any desired direction, and its output would be exactly the same as if it were placed in the same position during the original recording!

In practice, of course, there is no need to first reproduce the sound field and then re-record it. The same result can be obtained by electronically blending the four B-Format signals. This is achieved with the aid of a 'soundfield signal control unit'. This unit contains controls with which any first-order microphone characteristic can be synthesised: that is the complete range from omnidirectional, through cardioid and hypercardioid to figure-of-eight. In theory, any number of such microphones can be synthesised simultaneously, but the Calrec unit provides a mono output, a stereo pair, conventional 'quadrophonic' outputs and Ambisonic B-Format periphonic or horizontal outputs.

Controls are provided which allow the synthesised microphones to be rotated and/or tilted, and the directivity may be varied from cardioid to hyper-cardioid. Furthermore, in stereo the angle between the two microphones of the synthesised pair may be varied at will. All these facilities are available both during the live recording session and in post-session processing of the B-Format tape. This means that after having made the recording it is still possible to 'aim' the microphone at a soloist, and even 'zoom in' by selecting the extreme hyper-cardioid characteristic! All in all, the soundfield microphone should prove to be a welcome and powerful tool for those who are interested in high-quality sound recording.

*Calrec Audio Limited,  
Hangingroyd Lane,  
Hebden Bridge,  
West Yorkshire HX7 7DD,  
England*

## Four-ear quad

Reproduction of sound with directional information can be done with two-channel systems. Of these, there are two basic types: conventional stereophony and the binaural system. By far the best-known is conventional stereo; basically, this can be described as the reproduction of two mono signals through two loudspeakers, whereby amplitude differences between the two channels determine the position of the 'phantom' image in the total stereo picture. In recent years, an alternative system has been discussed extensively: the binaural system, or dummy-head stereo as it is popularly referred to. As the name implies, dummy-head recordings are made with an artificial head that has microphones inside its ears.

Both systems have their disadvantages. Localisation in conventional stereo is not particularly good: the amplitude differences between two channels are not sufficient for precise and accurate image localisation. Dummy-head recordings, on the other hand, suffer from the drawback that conventional mixing and panpotting in the recording studio cannot be used; furthermore, the system is only suitable for reproduction through headphones - loudspeaker reproduction is distinctly inferior even to conventional stereo. The reason for this is that 'acoustic crosstalk' occurs, with sounds from the right-hand loudspeaker reaching the left ear and vice versa. It is probably no coincidence that the most fervent proponents of dummy-head stereo happen to be manufacturers of headphones!

Most of the problems associated with dummy-head recordings have been solved in the so-called Bi-phonic system proposed by JVC. A special processor in the recording studio offers multi-mike and panpotting facilities, and produces two output signals that will tolerate a normal amount of acoustic crosstalk.

JVC have now announced a further extension of this principle. The Q-Biphonic system is intended for reproduction using four loudspeakers instead of two. In this way, a major



# selektor

## This is your captain speaking . . .

A Public Address installation is useless if it cannot be clearly heard in spite of background noise. This can be quite a problem when the system has to compete with really high background noise levels, such as on board jet aircraft, in supermarkets and in factories. On the one hand, clear intelligibility can be vital, especially in case of emergency; on the other hand, simply boosting the power until speech or music-while-you-work is clearly audible will well increase the already high sound level to the point where it becomes completely unacceptable.

Obviously, the requirements placed on this type of installation have very little in common with those for a hi-fi installation. Low distortion and flat frequency response are relatively

unimportant; the main thing is to get the message across clearly. The portion of the frequency spectrum that contains most of the speech (or music) information must be raised above the background noise level, and at the same time the peak level must be kept as low as possible in order to minimise the danger of hearing damage. After extensive research, Philips have recently demonstrated a system that goes a long way towards satisfying these demands.

The proposed system utilises the fact that there is a marked difference between the power spectrum and the 'intelligibility spectrum' of speech. If the speech band is subdivided into eight octave bands, it is possible to determine the average power in each band and the contribution of each band to the intelligibility. The result of this type of analysis is well-known: most of the power goes into the lower bands, whereas the higher bands are more important for intelligibility. This means that if speech is fed through a high-pass filter with a suitable cut-off frequency, the power may be drastically attenuated without losing much in intelligibility. For example, if a cut-off frequency of 1 kHz is used, the power will be reduced to 25% and the intelligibility to 92% of the original values. Or, to take an even more extreme case: a cut-off frequency of 1400 Hz will reduce the power to 14% and the intelligibility to 87%.

If this was the only proposal, the system could hardly be called revolutionary.

But there is more. The dynamic range of normal speech (the difference between highest and lowest levels) is approximately 35 dB — a power ratio of some 3500:1. It has been shown that intelligibility hardly suffers if this range is drastically compressed to approximately 5 dB — 3.5:1! This means that if the lowest levels are boosted to just above the background noise, the highest peaks need not be more than 5 dB higher.

The way in which Philips has utilised these two approaches in one system is illustrated in figure 1. Figure 1A shows the frequency spectrum and dynamic range of normal speech. The dotted line approximates a hypothetical background noise level; the 3 dB/oct. roll-off (pink noise) is usually encountered in practice. This dotted line can be considered as threshold of audibility: any speech signal below this level will be unintelligible. Using a conventional PA installation, even boosting the peak level to 35 dB above the background noise at 400 Hz will not be sufficient to guarantee good intelligibility!

Figures 1B, 1C and 1D illustrate the three main steps in the new speech processing system. First, the bass is cut and the treble is boosted, so that the spectrum becomes essentially flat above approximately 1500 Hz (figure 1B). Drastic compression is now applied (figure 1C), reducing the dynamic

range to 5 dB. Finally, a treble roll-off is applied (—3 dB/oct. above 1500 Hz), bending the characteristic down onto the background noise and avoiding unnaturally pronounced 'S' sounds (figure 1D).

Comparison of figure 1A with figure 1D shows the drastic reduction in power. It seems scarcely credible that the intelligibility should actually be improved by such a drastic approach! However, the demonstration given by Philips was very convincing. They simulated part of the cabin of a jet passenger aircraft, with a row of loudspeakers down one side reproducing the noise normally heard during take-off, and the normal overhead loudspeaker mounted above each row of seats. An announcement read over the conventional installation was, as usual, virtually unintelligible. Anybody who has ever travelled by air will know the effect . . . They then switched over to the new system — and suddenly every word came out loud and clear. The peak power available for each overhead loudspeaker was 50 milliwatts! Music can, of course, be dealt with in the same way. However, in that case the low end of the frequency spectrum will have to be extended and the dynamic range compression cannot be quite as drastic.

Philips Electro-Acoustic Division,  
Breda, Netherlands.

(308 S)

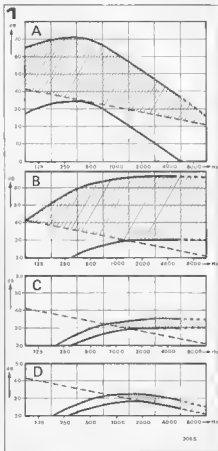

## XY recorder helps stroke victims

Tracking responses plotted on a Bryans XY recorder can help in the rehabilitation of stroke patients, as a result of a pioneering research programme in Bristol. The recorder is providing hard copy records of experimental results gathered by computer at the Avon Stroke Unit at Frenchay Hospital. The recorder in use is a 26000 series model from Bryans Southern with A4 plotting area, rack mounted as part of the PDP-11 online digital computer system.

The Bristol research team set out to explore ways of measuring and recording the degree of dynamic control loss in the affected limbs of stroke patients. To do this, they applied the 'tracking task' principle usually associated with the study of man/machine relationships in critical areas such as high performance aircraft and spacecraft design. In their experimental setup, the computer supplies target and operator symbols on an oscilloscope screen in front of the patient. While the target disc moves in a random one-dimensional manner across the display, the second symbol, a cross, shows the patient's response in tracking it. The patient's forearm is supported in a pivoting rest with a potentiometer attached. Through the one minute test period, the Bryans XY recorder is

# selektor

works on order producing permanent plots of the patient's response performance in its system. At the same time the computer is processing the gaze/time diary information for storage and subsequent analysis via a teletype network.

The research programme is continuing work to ripple into the reasons for loss of limb control in the patient. However, the basic point has already been established, that reliable and objective measurements can be made by this system, to assess the effectiveness of treatment.

**Lankfordrow Martin & Associates Limited, Woodbridge House 48 Cheshamwell Green London, SE18 6EN**

129030

even at very low power. Well these painless and also aseptically prepared in a sterile state good candidates for acupuncture?

On the basis of the laser beam beams and near laser beams with a wavelength of 632 nm are obtained. For this range of the spectrum the full transparency of the human skin is its greatest, so that perceptible effect is not obtained even with maximum irradiation power. A therapy most advised by the manufacturer Sellow Lichten GmbH needs the designation: selektor laser system. It is a tube (LGM 7021) whose laser power with a beam diameter of 1 mm is only 2 mW yet which has powerful beams of 5 and 10 milliwatts depending on the type of laser.

For in the tube, the laser beam is guided via a glass-fiber cable into the thin, transparent part, which can be placed directly on the skin. The concentration of laser light is a great advantage to apply its action exactly to points on the body which according to the laws of acupuncture, reflect the various organs of the body in a diagram of this type of acupuncture treatment. The results of the studies show how the experiment can be used in the treatment of skin diseases. The method can be performed in primary pain locations as well as on distant symptoms. Depending on individual tolerance the irradiation power of the HeNe tube is adjusted to values between 1 mW and 100 mW. The duration of action may be up to 60 s.

**Siemens AG, Division for Laser and Optics, Postfach 103, D-8000 München 1, Federal Republic of Germany**

131851

# coming soon

## Elektor Software Service



AND

Summer circuits issue with over 100 circuits

- touch key control
- running lights
- dishwashers watches
- A/D converter
- car voltage monitor
- bicycle speedometer
- bit receiver
- model railway lights
- IR light gate
- universal data-bus buffer
- burglar alarm
- FM tones
- two signal gate outputs
- power supplies
- stereo 101





# aerial systems for satellite communication

There is no doubt that the role of satellites in the field of telecommunications is becoming ever more significant. The immediate future promises the widespread appearance of TV satellites, whilst in America the Satellite Business System will open the way for large business concerns to communicate with their transcontinental or foreign affiliates by 'buying' satellite time. The expected increase in the volume of satellite transmissions means that in order to utilise to the full the capacity of the satellites, ever higher frequencies will be used. Since the transmission frequencies which are currently employed already extend up into the 14 GHz (!) waveband, it is clear that designing a suitable receiver aerial is no easy task.

## Effective parameters of satellite aeriels

The most important parameters for the performance of satellite aeriels are the gain,  $G$ , of the aerial, which partly determines the strength of the received signal, and the noise temperature,  $T$ , which largely determines the amount of noise (interference) in the signal. It is the ratio between these two figures which effectively defines the obtainable quality of reception.

As far as gain is concerned, it is measured with respect to a so-called *isotropic* aerial, i.e. one which receives signals equally well from all directions (or radiates a signal equally in all directions). The gain of such an aerial is, by definition, 0 dB. Isotropic aeriels are frequently used as a reference in order to express the gain or directivity of another aerial. For example, the gain of a dipole is 2.15 dB (1.64 times greater) with respect to an isotropic aerial. Generally speaking, the higher the gain, the larger the dimensions of the aerial. Unfortunately, a larger aerial is not only more expensive, it also places greater demands upon the mechanical construction and alignment controls.

For satellite transmissions, the gain of the receiver aerial must obviously be sufficient to ensure an acceptable signal-to-noise ratio. In most cases a low-noise aerial preamplifier is also necessary. The cost of such a preamplifier however, rises sharply in relationship to the

The ever-increasing use of satellites for telecommunications purposes has focused considerable interest on the problem of designing suitable aerial systems for the reception of these extremely high frequency transmissions. This article takes a look both at some of the more commonly employed types of receiver aeriels, and also at a newly developed system, the so-called 'Vokurka aerial', which, it is claimed, not only offers improved reception, but is simpler and cheaper to construct than conventional aeriels.

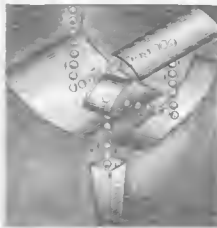

desired performance, so that a balance has to be struck between the size of the aerial and the type of preamplifier.

In addition to the received signal, the aerial output also contains noise which has been generated by the receiver itself. Were the aerial directed towards the 'warm' earth, then it would generate the same level of noise as an (ohmic) resistance which was at earth temperature. The noise power of a resistance is proportional to its absolute temperature,  $T$  (in degrees Kelvin). Thus if the temperature of the earth were  $20^{\circ}\text{C}$  ( $= 20 + 273^{\circ}$  Kelvin) the noise temperature of an aerial so directed would be  $290^{\circ}$  Kelvin.

A satellite aerial however, is, of course, directed into space, not at the earth, and the temperature of the former is virtually  $0^{\circ}$  Kelvin. An ideal satellite aerial would therefore have a noise temperature of  $0^{\circ}$  Kelvin and produce no noise voltage at all. In practice however, a satellite aerial does not have an ideal directivity, and hence, to a certain extent, still 'sees' the 'warm' earth, with the result that it has a significant noise temperature and generates an appreciable noise voltage.

Thus to resume briefly: a satellite aerial must have a high gain,  $G$ , and a low noise temperature,  $T$ . The sensitivity of the aerial can be expressed in the ratio  $G/T$ , whereby the greater this ratio, the better the aerial.

The above text mentions the concept of 'directivity'. This is illustrated in the diagram of figure 1, which consists of a large radiation pattern which is oriented in a particular direction, and several smaller peripheral 'lobes'. These side lobes should be as small as possible to prevent noise or interference being picked up from earth connections or indeed other satellites. As was already mentioned, the noise temperature of the aerial also depends upon the size and number of these lobes.

Finally, it is important that the aerial have a high cross polarisation rejection figure. In order to fully utilise the available space in the frequency bands, two signals which have opposite polarisation (e.g. vertical or horizontal) are transmitted and received on the same frequency. In order for this method of

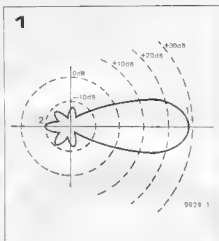

transmission to operate successfully, cross-polar rejection must be at least 30 dB.

**Aerial types**

Satellite aerials usually employ a reflector, of which there are a number of different types, but the most common of which is the parabolic reflector. The principle involved is simple: the reflector 'gathers in' the high frequency electromagnetic waves and focuses them to a spot (or a beam) where the actual tuned aerial or feed, as it is called, is situated. Figures 2, 3, 6 and 7 illustrate different types of aerial reflectors. They are respectively, the front-fed parabola, the cassegrain-parabola, the short-backfire, and the corner-reflector. Professional satellite receiving stations usually use one of the first two types.

The cassegrain aerial has the best (lowest) noise temperature, since the feed only receives spurious radiation from space (see figure 3). However the shadow effect of the subsidiary reflector proves a disadvantage. This can be avoided by using only a section of the reflector surface and arranging the position of the feed so that it receives radiation only from that part of the reflector. The resulting set-up is known as an offset aerial. It is also possible to use this arrangement with a front-fed parabola, and figures 4 and 5 illustrate these types of offset-parabolas.

Radio amateurs wishing to receive satellite transmissions are faced with the considerable problems which are involved in constructing a perfectly smooth parabolic surface. For example, in the case of a 4 GHz parabolic reflector, an irregularity of 2 mm in the surface of the reflector can cause a decrease in the aerial gain of 1 dB (11%). This is where the short-back-fire and corner-reflector can prove advantageous, since they employ plane reflectors, which are much easier to accurately make at home. The snag is however, that they have a limited gain. Increasing the surface area of the reflector does not produce the same improvement in the gain of the aerial as is the case with parabolic reflectors. The short-back-fire has a maximum gain of approx. 13 dB with a reflector diameter of 2λ (at

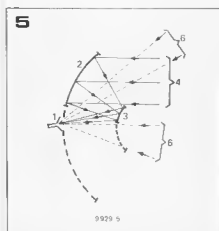
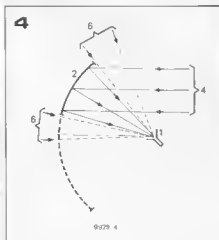
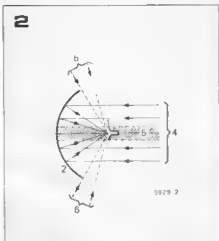

Figure 1. The diagram shows the directivity of an anisotropic aerial. The side loops (2) should be as small as possible compared to the main loop (1)

Figure 2. The front-fed parabola.

Figure 3. The cassegrain aerial.

Figure 4. The offset front-fed parabola (without shadow effect)

Figure 5. Offset cassegrain aerial (without shadow effect).

**Key to figures:**

- 1 = feed system
- 2 = parabolic reflector
- 3 = hyperbolic subsidiary reflector
- 4 = desired electromagnetic radiation (RF) from the satellite
- 5 = shadow region (no reception by feed)
- 6 = undesired radiation (earth noise, etc.)

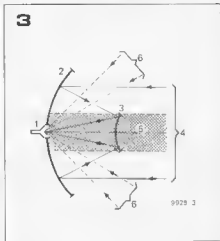

4 GHz the wavelength λ is 1/f.v = 8.3 cm). A larger reflector is only worthwhile if the number of dipoles is also increased. This however causes problems with the mutual coupling of different dipoles (see references 1). The maximum gain of the corner-reflector is restricted to approx. 15 dB, although the mechanical construction is slightly simpler than the short-back-fire aerial. In general, therefore, it can be said that both these latter types of aerial are inferior with respect to the G/T ratio, the level of side radiation and/or the degree of cross-polar rejection.

**The Vokurka aerial**

Until recently satellite aerials were designed by adapting existing types of aerial for the special requirements of satellite transmissions. Dr. Vokurka, however, working in collaboration with a research team at the Technical University of Eindhoven in Holland, has produced a satellite aerial which is of a completely new design. In his doctoral thesis (see references) he describes a type of reflector aerial which, at first sight, satisfies all the above-mentioned requirements. (Patent applications already exist with respect to all of Dr. Vokurka's designs.)

In the Vokurka aerial, the reflector is formed by a parabolic cylinder, which concentrates the electro-magnetic field into a narrow beam (rather than focusing it to a point, as is the case in normal parabolic aerials). The feed, for which a slotted waveguide is suitable, is then positioned in the line of the beam. If desired, a second reflector can be used to further focus the field, so that point-shaped feeds (such as e.g. the open end of a waveguide) can also be used (see figure 8a).

The aerial system is also suitable for offset-applications, and the received radiation from the feed can be completely screened by the use of metal plates, so that only the main reflector is illuminated. Dr. Vokurka also describes an aerial system which uses four reflectors (see figure 8b).

It is not difficult to manufacture the cylindrical reflectors used in the Vokurka aerials with a high degree of accuracy

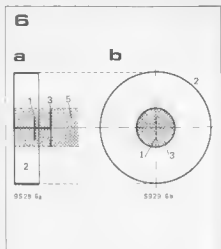

Figure 6. Side (6a) and front (6b) view of the short-back-fire aerial.

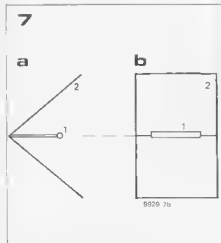

Figure 7. Side (7a) and front (7b) view of the corner-reflector aerial.

Figure 8. Two Vokurka aeriels, one with two (8a), and the other with four reflectors (8b).

Figure 9. This map shows the proposed coverage areas of the aerial systems onboard the second Orbital Test Satellite (OTS). The first OTS failed to reach orbit due to a failure of the launch vehicle. The second OTS is due to be launched this month.

Figure 10. An example of a cassegrain parabolic aerial (diameter 17 m). This aerial forms part of the OTS ground station at Fucino, Italy.

Figure 11. A front-fed parabolic aerial of the type depicted in this photo (diameter approx. 1.5 m) provides sufficient gain to receive transmissions from a TV satellite, but is difficult to construct from the point of view of an amateur. The 'shepherd's crook' serves to correctly position the feed and to carry the received signal to the receiver proper.

**Key to figures:**

- 1 = feed system
- 2 = parabolic reflector
- 3 = hyperbolic subsidiary reflector
- 4 = desired electromagnetic radiation (RF) from the satellite
- 5 = shadow region (no reception by feed)
- 6 = undesired radiation (earth noise, etc.)

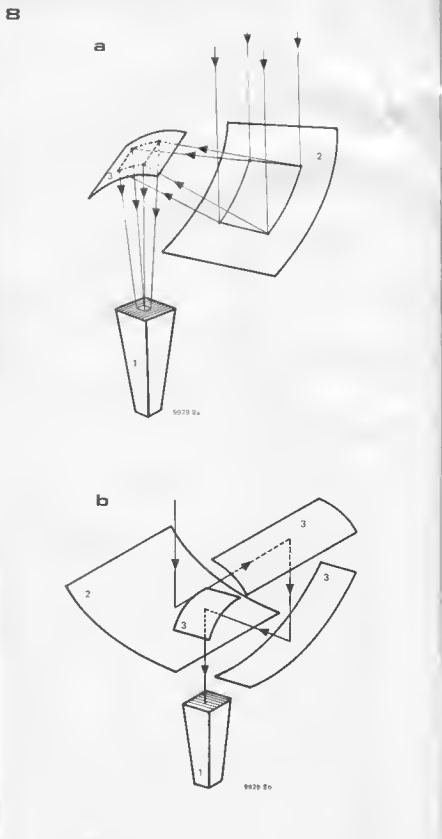

(i.e. surface evenness). One problem which remains however is the feed. The final radiation pattern of the aerial depends to a large extent upon the radiation pattern of the feed. In the Vokurka aerial systems, grooved horns are used, which have the advantage that they can be accurately calculated, so that practical results should correspond closely to theory. However constructing grooved horn aeriels is no easy matter,

and hence for amateur applications some other type of feed, such as smooth horns, may prove worthwhile. In view of the complicated calculations which the use of smooth horns involves, they have as yet not been tried.

The conclusions which can be drawn from Dr. Vokurka's thesis seem to indicate that this new type of aerial could well become standard for the reception of satellite transmissions. In

9

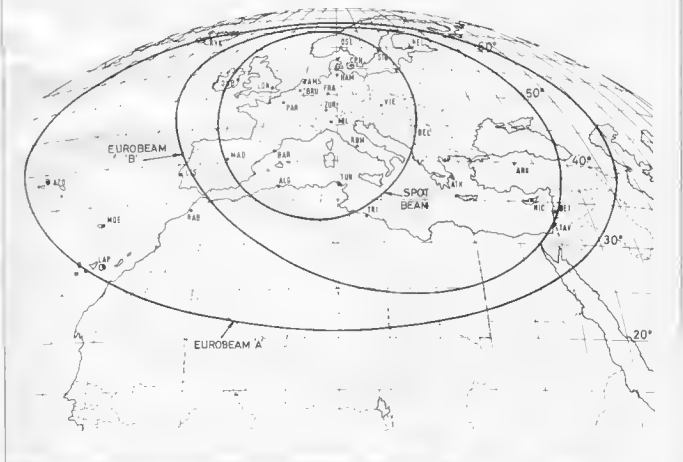

10

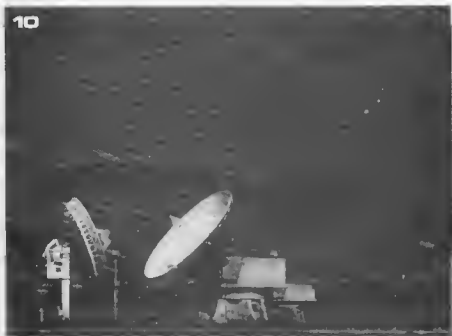

view of the relative ease with which cylindrical reflectors can be made, the Vokurka aerial also appears to offer interesting possibilities for amateur applications. The next stage in the process is the development of a simple feed (the 'true' aerial, which converts the electromagnetic radiation into an electrical signal, which meets the above-mentioned requirements. It is to be hoped that this area will not prove to

be a stumbling block for the use of the Vokurka aerial by amateurs.

#### References:

Doctoral thesis 'Feeds and reflector antennas for shaped beams' Vaclav Vokurka, TH-Eindhoven.

The Antenna Engineering Handbook, H. Jasik, publ. McGraw-Hill, New York  
Das Antennenbuch, K. Rothammel,

11



publ. Franck'sche Verlagshandlung, Stuttgart.

#### Photographs:

Figures 9 and 10: European Space Agency, Noordwijk  
Figure 11: Photographic agency TH, Eindhoven

# digital reverberation unit

One of the problems encountered when attempting to capture the sound of live music, is that such techniques as close-miking deprive the resultant sound of natural reverberation, so that the music loses the 'spacious' quality which is characteristic of 'concert-hall' sound. Similarly, if one is playing, for example, an organ or guitar in a small room, then because of the extremely short time taken for the sound to be reflected back from the walls, the loss of natural reverberation can make the music sound 'flat' or 'dead'. Thus, whether playing an instrument oneself or replaying pre-recorded music, a reverberation unit can restore the natural fullness of live sound and increase the apparent size of the listening room by artificially delaying a portion of the music signal and then summing the direct and delayed signals. At this stage it is perhaps useful to distinguish between reverberation and echo, since although similar they are normally taken to denote separate effects. Both result from mixing an audio signal with a portion of that signal which has been delayed. However echo is said to refer to the successively attenuated audible repetition of a particular sound (e.g. a word or a chord) by reflection, whilst reverberation describes the gradual decay of the signal. Basically, echo has a much longer delay time than reverberation, and since the delay times of the circuit described in this article are fairly short, it is primarily the phenomenon of reverberation in which we are interested here.

The most commonly-used types of delay line, i.e. the electro-mechanical units (incorporating springs, foils, plates etc.) almost all suffer from susceptibility to external sounds and vibration, whilst cheaper systems especially, often produce a metallic 'twangy' sound. The reverberation chambers and plates used in studio applications, which do offer realistic reverberation characteristics, are not only extremely expensive, but also their size and weight often makes them untransportable. Similar problems exist with tape echo/reverberation units: their inherent sensitivity to mechanical disturbance places tremendous demands upon the design and construction of such units — particularly if they are

**Artificial reverberation is an extremely useful sound effect which can be used to compensate for the small dimensions of most listening rooms by using a delay line to increase the proportion of 'reflected' sound heard by the listener. The resultant passage of music is therefore lent that extra dimension of 'spaciousness' or 'body' which is normally only captured during a concert-hall performance.**

**Of the many different methods of constructing a delay unit, this article describes the most advanced, namely a digital delay line.**

intended for professional applications. In view of these facts it is not surprising therefore that the trend is now towards completely electronic reverberation units, since not only are they more reliable, less bulky and lighter, but are able to provide faithful, uncoloured sound quality by relatively simple means. A further advantage — which this article does not explore — is the ability to incorporate such features as phasing or flanging.

The heart of an electronic reverb unit is the delay line, of which there are basically two different types: analogue delay lines (e.g. bucket-brigade memories and path filters) and digital delay lines (shift registers).

In the case of digital delay lines, an analogue signal can be delayed by first using an A/D converter to convert the analogue waveform into a corresponding digital code, which is then changed back into analogue form at the output of the shift register by a D/A converter. Digital delay lines have certain advantages over their analogue counterparts, since in the case of the latter type, the greater the delay time, the greater is the amount of attenuation they introduce into the signal.

The block diagram of a digital reverberation unit is shown in figure 1. The analogue input signal is amplified and then encoded into binary by the A/D converter. This signal is delayed by clocking it through a shift register and then converted back into an analogue waveform by the D/A converter. The delayed analogue signal is attenuated and summed with the original analogue input to produce the output signal. As is apparent, the delayed signal is once more sent 'round the houses', so that the sound is made to decay gradually.

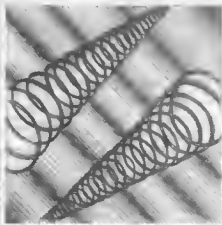

## Delta modulation

There are a large number of ways of converting an analogue signal into a binary equivalent, of which the most well-known is pulse code modulation. This involves sampling the analogue signal (at a frequency at least twice the highest signal frequency) to obtain a binary code which represents the quan-

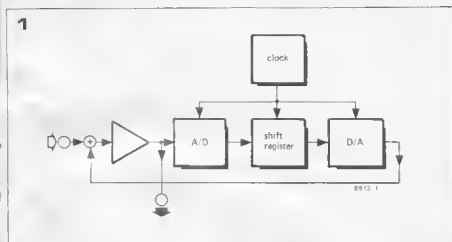

Figure 1. Block diagram of a digital reverberation unit. The analogue input signal is converted into digital form, delayed in a shift register, and then reconverted into analogue form.

Figure 2. An illustration of the process of delta modulation. The modulus  $U_\delta$  indicates whether the feedback signal  $U_y$ , which approximates the original input signal, is increasing or decreasing.

Figure 3. Block diagram of a linear delta modulator. The modulator employs a feedback loop, so that the input signal is compared with the locally demodulated output signal.

Figure 4. Block diagram of an adaptive delta modulator. The step height  $\gamma$  is determined by the envelope of the analogue input signal.

tized value of the instantaneous samples. The resulting binary data can then be processed, e.g. fed through a shift register, either serially or in parallel. This method, of which there are many different variations, does however suffer from several drawbacks. The most serious of these are firstly, the need for a lowpass filter with a fast roll-off to remove the clock frequency components at the demodulator. Secondly, in the case of serial conversion, the need for the demodulator to be exactly synchronised with the serial data output, and finally, the considerable amount of distortion and interference which can be produced as a result of defects in the detection process.

A form of analogue-digital conversion which is less susceptible to the above disadvantages is *delta modulation*. This method is illustrated in figure 2. Basically what happens is that the (low frequency) analogue signal  $U_x$  is approximated by a signal  $U_y$  which is either continuously increasing or continuously decreasing. The output of the delta modulator, the modulus  $U_\delta$ , gives a continuous indication of whether  $U_y$  is increasing or decreasing: if the former is the case, then  $U_\delta$  is a logic '1'; if  $U_y$  is decreasing, then  $U_\delta$  is logic '0'. In this way increments and decrements in the level of the analogue input signal are converted into a row of bits. If the analogue signal is constant, then the delta modulator will output ... 010101 ... etc.

Delta-modulation and, above all, -demodulation is in principle extremely simple. Demodulation in fact consists of nothing more than integrating  $U_\delta$ , and in its simplest form merely requires an RC network.

A block diagram of a delta modulator is shown in figure 3. As can be seen, the circuit employs a feedback network. A local detector (integrator) converts the stream of bits from the output signal  $U_\delta$  into the  $U_y$  signal. The analogue input signal  $U_x$  is compared with  $U_y$ , and if the former is greater, then the output of the comparator swings high, whilst if the level of  $U_x$  is lower than that of  $U_y$  the output of the comparator goes low. At each clock pulse the output of the flip-flop assumes the instantaneous

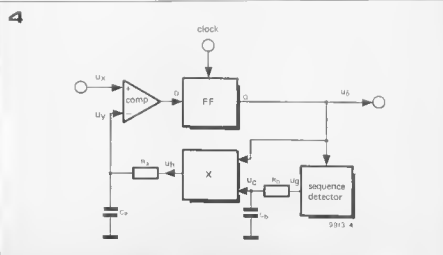
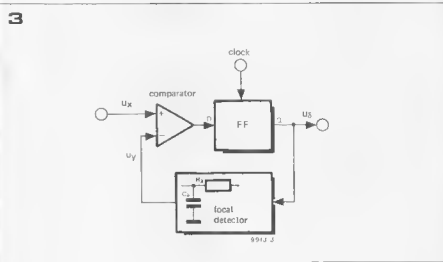
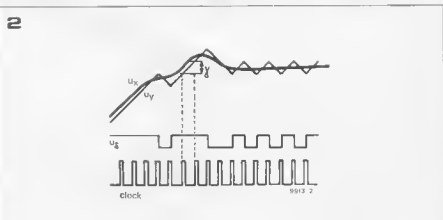

5

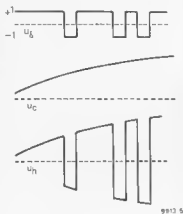

Figure 5. The signal  $U_h$  from the multiplier is the analogue product of the binary signal  $U_b$  and the analogue control signal  $U_c$ .

Figure 6. A simplified internal circuit diagram of the FX 209, which can be used both as a delta-modulator and demodulator.

Figure 7. The FX 209 connected as an adaptive delta modulator.

Figure 8. The same IC, now connected as an adaptive delta demodulator.

Figure 9. The pin-out of the 1024-bit shift register, the AM 2533, AM 2833 or the MM 5058.

Figure 10. Complete circuit diagram of the digital reverberation unit. In principle, the number of shift registers can be increased indefinitely.

Figure 11. Circuit diagram of the double power supply for the digital reverberation unit. Both supply rails are equipped with overvoltage protection. If only the basic version of the circuit is being used the power supply can be scaled down accordingly — see text.

6

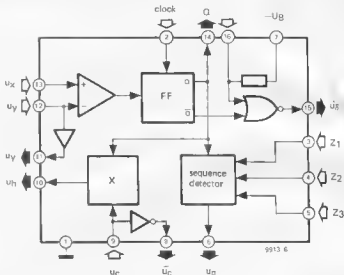

7

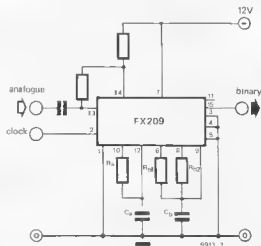

8

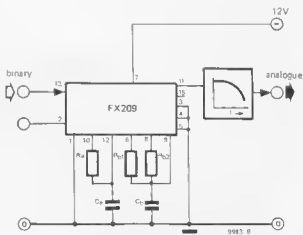

9

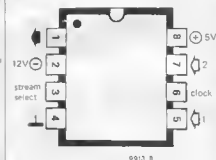

value of the comparator output. The modulator therefore indicates the direction or polarity of the difference between the input signal and the feedback signal from the local detector. Hence the name delta modulator, since the symbol delta is often used in mathematics to denote small differences.

### Adaptive modulator

The system of modulation described above is known as *linear delta modulation*. The extent to which the demodulated signal is distorted with respect to the original signal is determined by the ratio between the level of the input signal  $U_X$  and the step height  $\gamma$  (see figure 2), which corresponds to the increase (or decrease) in the analogue waveform represented by a one bit change in the digital output. If the step height remains constant, then a small

input signal will suffer a greater degree of relative distortion than is the case with a larger input signal. However it is possible to considerably reduce the *average* distortion by making the step height dependent upon the level of the input signal.

The most obvious step would be to let  $\gamma$  vary in direct proportion to the instantaneous value of the input signal - i. e. give the modulator a non-linear transfer characteristic. However it has been established experimentally that for audio applications a better result can be obtained by varying the step height in sympathy with the envelope of the input signal. A modulator in which the step height is dependent upon the envelope of the analogue signal functions in similar fashion to an automatic volume control and is known as an *adaptive or companded modulator*.

Figure 4 shows the block diagram of an

10

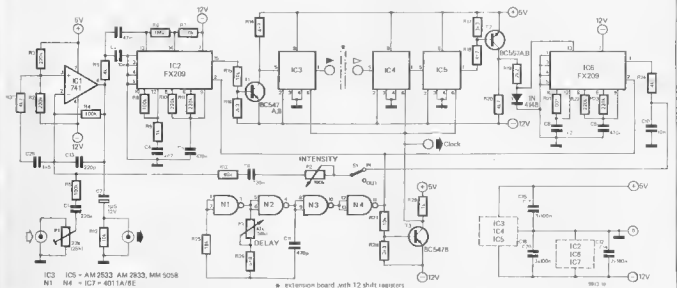

11

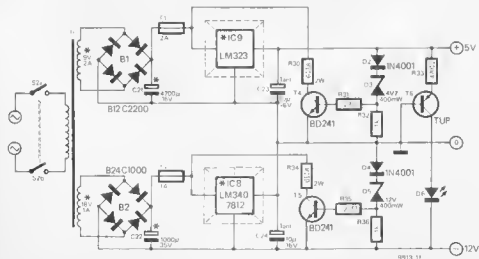

\* see text



Figure 12. Track pattern and component layout of the main board, onto which the circuit of figure 10 and the power supply of figure 11 are mounted (EPS 9913-1).

12

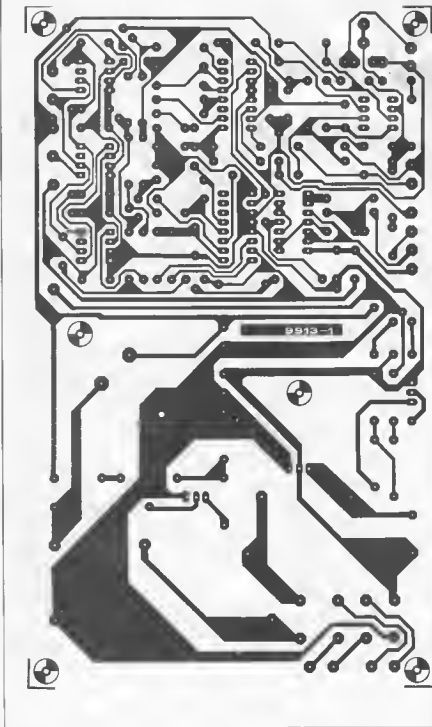

adaptive modulator.  $R_A$  and  $C_A$  form the integrating network of the local detector and fulfil the same function as their counterparts in figure 3, i.e. they convert the pulse train  $U_H$  into the analogue signal  $U_Y$ .

The output signal of the multiplier  $U_H$  is not the same as  $U_6$ , but is the (analogue) product of the binary signal  $U_8$  and the analogue control signal  $U_C$  (see figure 5). The control signal  $U_C$  is derived from a second integrator, namely  $R_B/C_B$ , which has a much larger time constant than  $R_A/C_A$ . The input signal,  $U_G$ , of this second integrator is a binary signal which is taken from a sequence detector and which is determined by the logic

value of  $U_6$  and the preceding pulses. Under certain conditions  $U_G$  will go high and remain in that state for a number of clock pulses. For example this is the case when the last three logic values of  $U_6$  are the same, i.e. all high or all low. The result is that  $U_G$  indicates a marked increase or decrease in the level of the input signal, since for  $U_6$  to remain high for a large number of pulses means that  $U_X$  must be continually increasing, whilst if  $U_6$  remains low, the reverse is true and  $U_X$  is steadily falling, and in both these cases  $U_G$  goes high. When  $U_G$  remains high for a considerable time, i.e. when  $U_X$  is increasing or decreasing very sharply, capacitor  $C_B$  will continue to

charge up. The result of that is to increase the step height of the pulse train  $U_H$  whenever  $U_X$  rises more than it falls, which generally coincides with an increase in the envelope of  $U_X$ .

#### Modulator ICs

The digital reverberation unit incorporates two ICs type FX 209. One forms the adaptive delta modulator and the other the adaptive delta demodulator. The IC, which comes in a 16 pin DIL package, uses negative logic, i.e. a logic '0' is represented by 0 V, whilst logic '1' refers to a negative voltage. Figure 6 shows a simplified internal

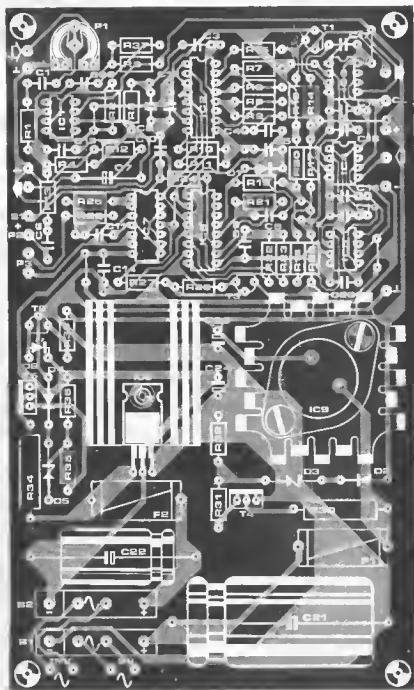

Parts list to figures 10 and 11  
(basic circuit)

**Resistors:**

R1, R4, R8, R21 = 100 k  
 R2, R3, R10, R11,  
 R22, R23 = 220 k  
 R5, R14, R18, R20,  
 R24, R37 = 4k7  
 R6 = 1M2  
 R7 = 270 k  
 R9, R29, R32, R36 = 1 k  
 R12, R15, R27 = 10 k  
 R13 = 68 k  
 R16, R17, R28 = 3k3  
 R19 = 2k2  
 R25 = 18 k  
 R26 = 6k8  
 R30, R34 = 6 $\Omega$ B/2 W  
 R31, R35 = 27  $\Omega$   
 R33 = 470  $\Omega$   
 P1 = 22 k (25 k) preset  
 P2 = 100 k lin  
 P3 = 47 k (50 k) lin

**Capacitors:**

C1, C6 = 220 n  
 C2, C10 = 10 n  
 C3 = 47 n  
 C4, C8 = 2n2  
 C5, C9 = 470 n  
 C7 = 1 $\mu$ 5/12 V  
 C11 = 470 P  
 C12, C14, ... C20 = 100 n  
 C21 = 4700  $\mu$ /16 V  
 C22 = 1000  $\mu$ /35 V  
 C23, C24 = 10  $\mu$ /16 V tantalum  
 C25 = 1n5

**Semiconductors:**

T1 = BC 547A, BC 547B or  
 equivalent  
 T2 = BC 557A, BC 557B or  
 equivalent  
 T3 = BC 547B or equivalent  
 T4, T5 = BD 241  
 T6 = TUP  
 D1 = 1N4148  
 D2, D4 = 1N4001  
 D3 = zener 4.7 V/400 mW  
 D5 = zener 12 V/400 mW  
 D6 = LED  
 IC1 = 741  
 IC2, IC6 = FX 209  
 IC3 ... IC5 = AM 2533,  
 AM 2B33, MM 5058  
 IC7 = N1 ... N2 = 4011  
 IC8 = LM 340, 7B12  
 IC9 = LM 323  
 B1 = 12 V/2 A Bridge rectifier  
 B2 = 24 V/1 A Bridge rectifier

**Miscellaneous:**

Tr = transformer 9 V/2 A,  
 18 V/1 A  
 F1 = 2 A quick-blow  
 F2 = 1 A quick-blow  
 S1 = single-pole switch  
 S2 = double-pole switch

block diagram of the FX 209. Most of the functional units should be readily recognisable from figure 3. A unity-gain amplifier is included to provide a low impedance version of  $U_6$  at pin 11. The binary output  $U_6$  is not only available direct from the Q output of the flip-flop (pin 14), but is also brought out via the Q output and a NOR gate to pin 15. Thus if pin 16 is left floating, the signal at pin 15 is the same as that at the Q output. The inverse of  $U_6$  is accessible at pin 8.

The logic level of the three inputs  $Z_1$ ,  $Z_2$  and  $Z_3$  control the operation of the sequence detector. If all three inputs are earthed and if the Q output remains the

same for three consecutive clock periods, then output 6 will go high for one clock period.

Figures 7 and 8 show how the FX 209 can be connected as an adaptive delta-modulator and -demodulator respectively. In both cases resistor  $R_A$  and capacitor  $C_A$  form the integrating network which functions as a local detector. The second RC-network, which has a larger time constant and is used to derive the control voltage  $U_C$ , is connected to pins 6, 8 and 9. Together with  $C_B$ ,  $R_{B1}$  determines the rise time and  $R_{B2}$  the decay time.

In the case of the modulator circuit, there is a feedback loop from the Q out-

13

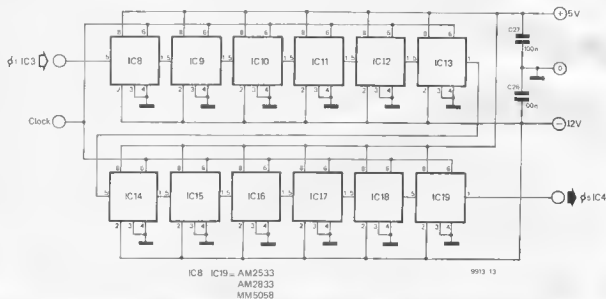

14

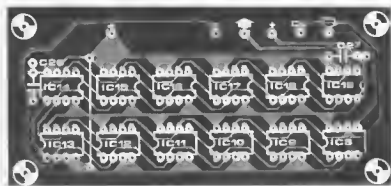
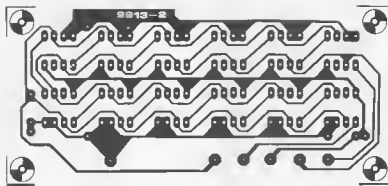

#### Parts list to figure 13 (extension board)

Capacitors:  
C26, C27 = 100 n

Semiconductors:  
IC8 . . . IC19 = AM 2533,  
AM 2833, MM 5058

put (pin 14) to the non-inverting input of the comparator. This is to ensure that in the event of a constant input signal level (e.g. 0 V) the modulator outputs the desired bit stream . . . 010101 . . . In the demodulator, the binary input signal is not fed straight to the flip-flop, but, as was the case in the modulator circuit, is routed to the non-inverting input of the comparator. Since the signal at the inverting input will always be smaller than the binary input signal, the output of the comparator will always follow the input signal of the demodulator. The comparator thus functions as a buffer, whilst the 'detour' taken by the input signal also spares an extra IC connection.

#### Shift registers

The shift register that is used to delay the binary-coded signal requires a certain amount of hardware-investment. It is formed by ICs type AM 2533, AM 2833 or MM 5058. Each IC, which comes in an 8-pin DIL package, contains a 1024 bit shift register. These IC

15

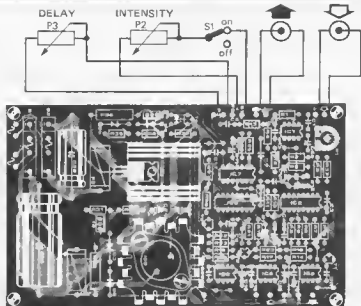

- A 24- 90 ms  
 B 120- 450 ms  
 C 220- 810 ms  
 D 310-1170 ms

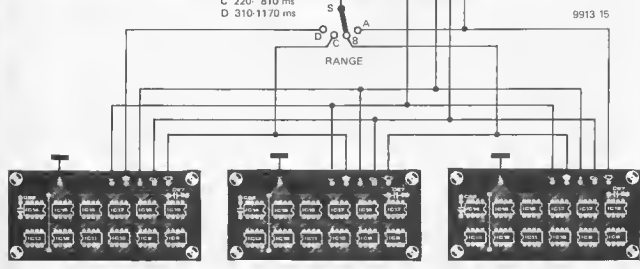

Figure 13. Circuit diagram of the extension board, which contains 12 shift register ICs and two decoupling capacitors.

Figure 14. Track pattern and component layout of the extension board (E9S 9913-2).

Figure 15. The most satisfactory solution is to connect the extension boards to the main board via a RANGE-switch.

use PMOS technology and require two supply voltages, namely +5 V (max. 30 mA per IC) and -12 V (max. 7.5 mA). Logic '0' refers to a voltage of roughly 0 V, whilst logic '1' is represented by approx. +5 V, i.e. TTL logic levels. For this reason a logic level shifter is needed between the shift registers and the FX 209's.

The shift registers require a single-phase clock pulse. When the clock input goes high, data is loaded into the register, and when the clock pulse goes low the data already present in the register is shifted along one bit. The maximum permissible clock frequency is 1.5 MHz. Figure 9 shows the pinout of the IC. The stream select input (pin 3) switches between the two inputs. When the stream select input is low, input 1 (pin 5) is the shift register input; on the other hand when it is high, then input 2 (pin 7) becomes the register input.

#### Circuit diagram

Figure 10 shows the complete circuit diagram of the digital reverberation unit. The input signal is fed to a unity gain

inverting amplifier, IC1, then fed to the adaptive delta modulator IC2. The circuit around this IC can be recognised as that shown in figure 7, the only alteration being the addition of a 1 k resistor (R9). This is included to render the modulator more stable at high frequencies.

The modulator is followed by a level shifter, built round T1, which shifts the logic voltage levels of the modulator output to those used by the shift register ICs. Three of these ICs, IC3, IC4 and IC5, are included in the basic version of the circuit, however additional shift register ICs can be incorporated between IC3 and IC4. For this purpose an extension board, containing 12 extra ICs, has been designed, and one or more of these boards can be used to increase the delay time of the circuit.

The last shift register, IC5, is followed by a second level shifter, built round T2, to adjust the output levels of the shift register to suit the logic voltage swing of the demodulator. Diode D1 is included to protect the FX 209 against large positive voltage peaks. The latter IC,

which is connected as an adaptive delta demodulator, is in turn followed by a simple lowpass filter, consisting of R24 and C10. This filter removes all frequencies above approx. 3.4 kHz.

When S1 is in the 'IN' position, the delayed signal is fed via P2 (which allows the intensity of the reverberation to be varied) back to the input of the op-amp along with the input signal. Thus the output of IC1 consists of the original input signal plus the reverberation or delayed signal and constitutes the output signal of the complete circuit.

The delta-modulator, -demodulator and the shift registers are clocked by a squarewave generator built round NAND's N1 and N2. N3 and N4 function simply as buffers. At the output of N4 is a squarewave signal which varies between 0 and -12 V, and this is used to drive the FX 209's. T3 adjusts the level of the clock pulses to that of the shift registers. The clock frequency, and hence the delay time of the circuit, can be varied between approx. 30 kHz and 120 kHz by means of potentiometer P3 (DELAY). The delay time per shift register (1024 bits) can thus be varied between approx. 8 ms and 30 ms, so that the basic version of the circuit has a delay time of between 24 and 90 ms, whilst the basic circuit supplemented by one extension board (a total of 15 shift registers) will delay the input signal by between 120 and 450 ms. In the latter case the effect produced is very close to echo, a shortish word being clearly repeated.

## Supply

The digital reverberation unit requires two supply voltages, +5 V and -12 V. Figure 11 shows the circuit diagram of a suitable power supply which, in addition to the basic circuit, can provide sufficient current for up to four extension boards. The +5 V supply will provide up to 2.5 A, whilst the -12 V rail will supply over 1 A.

The two voltage regulators (IC8 and IC9) provide both supplies with current limiting and thermal protection. In addition the two supplies are also protected against overvoltage. The latter facility prevents excessively high voltages appearing on the supply lines as a result of a defect in the regulator ICs or faults in the construction. Although this may appear to be an excess of caution, in view of the price and the vulnerability of the ICs used in the circuit, it is well worth investing a little extra and being safe rather than sorry.

The overvoltage protection for the +5 V rail is provided by T4. When the supply voltage exceeds the zener voltage of D3 plus the forward voltage drop of D2 (i.e. greater than  $4.7 + 0.7 = 5.4$  V) T4 will turn on causing fuse F1 to blow. The -12 V rail is protected in exactly the same manner by means of T5 etc. If only the basic version of the circuit is

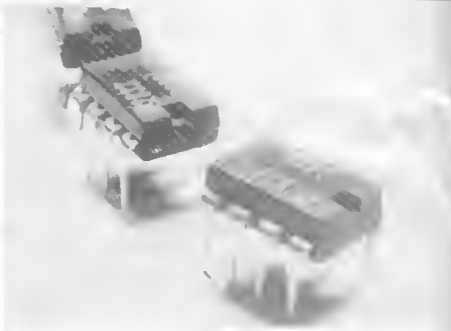

being used (i.e. three shift register ICs) - which nonetheless still produces a clear reverberation effect - then the supply requirements can be scaled down somewhat. The transformer need only deliver 100 mA at 9 V and 50 mA at 18 V. The bridge rectifiers can also be trimmed down: for B1 and B2 a 12 V/100 mA rectifier and a 24 V/100 mA rectifier respectively should prove sufficient. The reservoir capacitor C21 can be reduced to 1000  $\mu$  and C22 to 220  $\mu$  (both retaining the same operating voltage). F1 becomes 150 mA, F2 75 mA, both quick blow, whilst a 7805 can be used for IC9.

## Printed circuit board

The basic version of the circuit, shown in figure 10, and the power supply of figure 11 can both be mounted on the same printed circuit board. The track pattern and component layout for the board is shown in figure 12. The voltage regulators IC8 and IC9 should both be fitted with a heat sink.

Assuming one takes the usual precautions when working with MOS ICs, construction of the circuit should not present any problems. The use of sockets is a must when mounting the ICs. Quick-blow fuses should be used for F1 and F2. If extension boards are not being used then the output of IC3 should be joined to the input of IC4 by a wire link.

The circuit diagram for the extension board is shown in figure 13. As can be seen, this circuit simply contains 12 shift register ICs of the same type as IC3...IC5 and two 100 nF decoupling capacitors. The track pattern and component layout of the board is shown in figure 14.

It is possible to connect several extension boards to the basic version of the circuit, and it is recommended to incorporate at least one complete extension

board in the final version of the reverberation unit. Although the basic circuit produces a clear reverberation effect, sufficient for use in, e.g. an electronic organ, the quality and intensity of the reverberation does not lend itself for more than a limited range of applications. A useful idea is to connect the extension board(s) to the input of IC4 via a switch. Figure 15 illustrates a digital reverberation unit composed of the basic circuit and three extension boards. The range of the DELAY potentiometer P3 can be set by means of switch S. Since increasing the clock frequency also increases the permitted bandwidth of the reverberation signal, this means that the sound quality of the output signal is best when the delay time of the reverberation is relatively short, i.e. when the DELAY potentiometer is set to a relatively small value.

The sensitivity of the circuit can be adjusted by means of the preset potentiometer P1, which should be set to prevent the circuit overloading - this being noticeable by sudden pronounced distortion. The input sensitivity of the circuit can be varied between 10 mV and 3 V<sub>pp</sub>. If the reverberation unit is to be used alternately by a number of different signal sources, then a conventional (logarithmic) potentiometer can be used for P1.

# mini short-wave receiver

This handy short-wave receiver, which covers the frequency band from 3...12 MHz, is one of those projects which are almost simpler - and certainly more fun - to build than to describe! However, not only is the receiver extremely easy to construct, it is also inexpensive, requires no alignment, and offers eminently reasonable performance. Certainly, for a receiver of this type, no-one can complain about a sensitivity of 1  $\mu$ V for 10 dB signal-to-noise ratio over the entire bandwidth. The extremely high input impedance also helps to ensure adequate selectivity using a simple 1 m whip aerial. What is more, since the antenna circuit is untuned, the tuning is not affected by the characteristics of the aerial.

Since this receiver also affords considerable control over the amount of feedback or regeneration, it is possible to adjust the latter to just above the level at which the detector stage starts to oscillate, so that, in principle, the receiver can also be used for CW- and SSB-signals. However, it should be stressed that this receiver is basically intended for AM signals.

One feature of the circuit which will prove popular with many readers is that it requires only one self-wound coil, which, furthermore, is without any taps or coupled windings. Thus the business of actually winding the ring-core coil (sometimes known as toroid cores) should not prove too time-consuming. The final point in this receiver's favour is the moderate current consumption, which means that it will operate quite happily off an ordinary 9 V battery.

## The circuit

The complete circuit diagram of the mini short-wave receiver is shown in figure 1. As can be seen, it consists of a dual-gate MOSFET input stage, a buffer stage (T2) and a detector (T3). The circuit is completed by a simple AF amplifier (T4...T7).

The aerial input signal is fed to one of the gates of MOSFET T1, which functions as a selective input amplifier. The aerial input has a very high impedance, and since there is no aerial tuning the input of the receiver covers a broad band of frequencies.

Although hardly qualifying for the accolade of 'state-of-the-art', this simple little short-wave receiver, which employs a single tuned circuit and a regenerative detector, boasts a number of attractive features.

The only variable tuned circuit is situated in the drain of T1; programme tuning is therefore effected by means of variable capacitor C1.

The input amplifier is followed by an ordinary J-FET (T2), which functions as a buffer. The signal at the drain of T2 is in phase with the input signal, and a portion of the former is fed back to the input of the RF-amplifier T1, thereby providing regeneration. The regeneration considerably improves not only the sensitivity, but also the Q and hence the selectivity of the detector stage, and should be set just below the level at which the detector starts to oscillate. Since the second gate of T1 is used for the feedback signal this has much less effect upon the aerial input, which is coupled to the other gate, than is normally the case. Without further ado, P1 can therefore be set for maximum selectivity and sensitivity.

The detector stage is formed by T3. Volume control is provided by potentiometer P2, which is situated in the collector of this transistor.

The AF amplifier T4...T7 is of a completely conventional design and requires no further explanation. The only point worth noting is that despite using ordinary BC type transistors it nonetheless develops a highly acceptable output volume level.

## Construction

A printed circuit board, the track pattern and component layout of which is shown in figure 2, was designed to accommodate the mini short-wave receiver. As is apparent from the photo in figure 3, construction of the receiver should not prove a particularly arduous or time-consuming task. Even the self-wound coil (L2) should not present any problems. 40 turns of 0.2 mm enamelled copper wire are wound onto a powdered iron ring core approx. 10 mm in diameter, type T50/6 from Amidon. (L2  $\approx$  10  $\mu$ H). The turns should be spaced evenly round the circumference of the ring core, and the coil can then be fixed to the board with a spot of glue. Although in principle any variable capacitor of between 250 and 300 pF

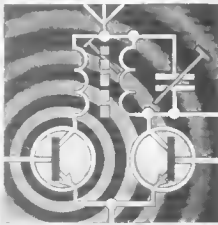

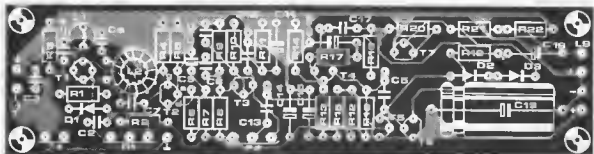
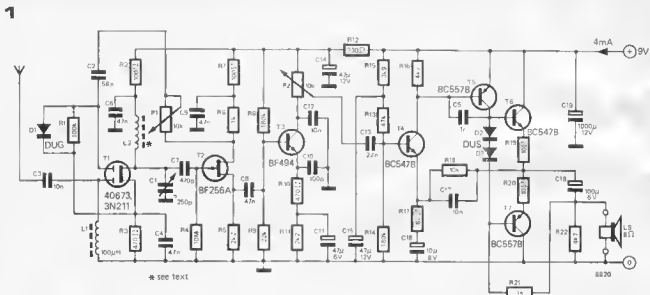

## Parts list to figure 1.

## Resistors:

R1 = 100 k  
 R2, R7 = 100 Ω  
 R3, R10 = 470 Ω  
 R4 = 10 M  
 R5, R11 = 2k2  
 R6, R21 = 1 k  
 R8, R14 = 180 k  
 R9 = 22 k  
 R12 = 330 Ω  
 R13 = 47 k  
 R15, R18 = 10 k  
 R16, R22 = 4k7  
 R17 = 82 Ω  
 R19, R20 = 10 Ω

## Capacitors:

C1 = tuning capacitor 5... 250 p  
 (see text)  
 C2 = 56 p (ceramic)  
 C3, C12, C17 = 10 n  
 C4, C6, C8, C9 = 47 n  
 C5 = 1 n  
 C7 = 470 p (ceramic)  
 C10 = 100 p (ceramic)  
 C11 = 47 μ/6 V  
 C13 = 22 n  
 C14, C15 = 47 μ/12 V  
 C16 = 10 μ/6 V  
 C18 = 100 μ/6 V  
 C19 = 1000 μ/12 V

## Semiconductors:

T1 = 40673 (RCA), 3N211,  
 BF 900 (TEXAS)  
 T2 = BF 256A  
 T3 = BF 494, BF 194, BF 195,  
 BF 199, BF 173  
 T4, T6 = BC 547B, BC 107B or equ.,  
 T5, T7 = BC 557B, BC 177B or equ.,  
 D1 = DUG  
 D2, D3 = 1N4148

## Miscellaneous:

P1 = 10 k lin.  
 P2 = 10 k log.  
 L1 = RF choke 100 μH  
 L2 = 40 turns 0.2 mm wire onto  
 Amidon ring core type T50 mix 6

4

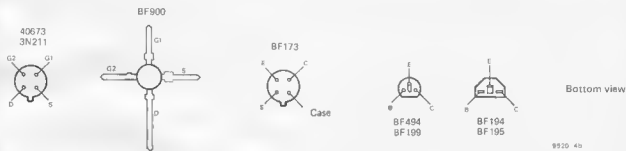

maximum capacitance may be used for C1, the minimum capacitance should not be less than the recommended value of 5 pF otherwise the receiver will most likely fail to pick up any signals at the top end of the tuning range.

Finally, it is worth mentioning that the receiver can be adapted to pick up other short-wave bands by experimenting with the values of L2 and C1.

### Short-wave conditions

Short-wave broadcast reception is possible only because of the existence of an electrified region high in the earth's atmosphere, called the ionosphere. The ionosphere acts somewhat like a mirror reflecting radio signals back to earth over great distances.

The greater the intensity of ionization the more the higher frequencies will be reflected back to earth. As night falls the ionization of the ionosphere gradually decreases. As this happens the 'maximum usable frequency' (muf) begins to decrease and the higher frequency bands start to fade-out one by one. This effect is more noticeable during the winter months. Reception conditions on the various short-wave bands vary according to the time of day and season of the year. Reception in the lower short-wave bands (the ones this receiver picks up) is usually better in the evening and early at night.

### Who is transmitting

Almost every country in the world has some short-wave broadcast transmitters. The times, frequencies and power these stations use vary greatly.

When the band is open and by using good listening techniques the world is yours so good DXing **M**

Figure 1. The complete circuit diagram of the mini short-wave receiver, which, with the end of a short whip aerial, will provide good reception over the frequency band 3 ... 12 MHz.

Figure 2. Track pattern and component layout of the printed circuit board for the receiver (EPS 9920).

Figure 3. Photo of a completed prototype.

Figure 4. Pin-out of some of the transistors used in the mini-short-wave receiver.

Table 1. A list of standard short-wave broadcast bands which can be tuned with this mini receiver.

Table 1.

Band	Frequencies (MHz.)
90 m	3.2 ... 3.4
75 m	3.9 ... 4.0
60 m	4.75 ... 5.05
49 m	5.95 ... 6.2
41 m	7.1 ... 7.3
31 m	9.5 ... 9.775
25 m	11.7 ... 12.0

3

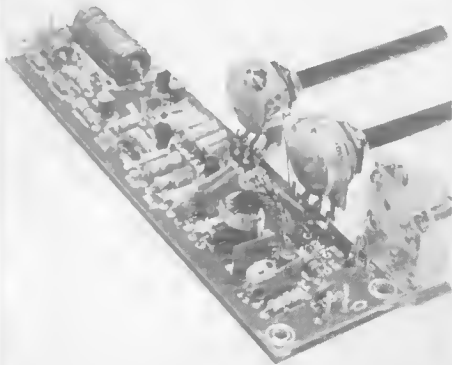



# ejektor

an invitation to investigate, improve on and implement imperfect but interesting ideas.

## TV scope using bucket brigade memory

An oscilloscope is an extremely useful, and in some cases virtually indispensable piece of equipment, which however, because of its price, is beyond the reach of most amateur constructors. This article takes a look at one idea for circumventing this problem, namely adapting an ordinary TV receiver for use as a low-cost oscilloscope for low frequency applications (up to roughly 200 kHz).

One approach, which at first sight seems attractively simple, is to, as it were, turn the TV on its side, so that the output of the line oscillator in the receiver sweeps the spot vertically up and down the screen. This process is illustrated in figure 1, where for the sake of clarity only a few of the 625 lines are shown. The spot is then blanked such that it is only visible at one point in each line, that point corresponding to the amplitude of the input signal voltage, i.e. the signal voltage is in effect sampled at the line frequency (15.6 kHz). The time base of the 'scope' is obviously determined by the field frequency, which is fixed at 50 Hz.

This set-up however, does suffer from a number of drawbacks:

a. the scope can only be used for low frequency signals, since, according to the sampling theorem, the sampling rate must always be at least twice the fre-

quency of the sampled signal. This naturally imposes an upper limit of 7.8 kHz upon the input signal.

b. the scope will only synchronise with signals of roughly 50 Hz or a multiple of 50 Hz. In most cases synchronisation and triggering will prove impossible.

c. since the signal is sampled every  $64 \mu\text{s}$ , a 50 Hz sinewave will consist of 20 ms:  $64 \mu\text{s} = 312$  discrete points; a period of a 500 Hz signal will contain 31 points, a 1500 Hz signal only 10 points, and signals above this frequency will obviously be unrecognisable, since they will be composed of fewer than 10 discrete spots!

The above mentioned disadvantages stem from the fact that the sampling frequency and the scope sync signal are derived from the line and field frequencies respectively of the TV receiver. This situation can be resolved by reading the input signal into a memory using a suitable sampling frequency, and then reading it back out of the memory at the line frequency of the receiver. The following possibilities suggest themselves:

a. the input signal is sampled (in a sample and hold circuit), converted into digital form, stored in a digital memory, then read out of the memory by the line frequency of the TV set (see figure 2). The advantage of this system is: since the signal can be read out of the memory several times, the design of the circuit can be arranged such that it is not necessary to turn the TV screen on its side. The disadvantage of this set-up is that an extremely fast A/D converter is required to enable signals of up to 200 kHz to be displayed on the scope, and the price of such a converter is currently greater than that of a 10 MHz oscilloscope! However, since the information stored in the memory can be retained indefinitely, the system offers the facilities of a storage scope.

b. the signal can be stored in an analogue bucket brigade memory and then read out at line frequency (see figure 3). The advantages of this arrangement are: the circuit is relatively simple, and the required ICs are not excessively expensive, so that the system can be built at low cost.

1

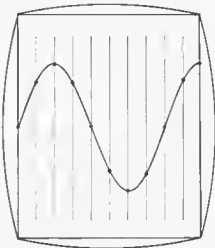

2



3



# vocoders (2)

As was mentioned in the first part of the article, the input speech signal is first converted into a set of data which will be used to control the synthesis of the output signal. The first stage in this process is to feed the speech signal to a bank of filters.

## Channel filters

The channel filters split the signal to be analysed into a number of frequency bands which are spaced evenly over the audio spectrum. An identical bank of filters in the synthesiser section of the vocoder also divides the excitation signal up into the same number of frequency bands.

The filter stages of all currently available vocoders are in principle very similar. The filters themselves are of the bandpass type, whilst the only differences that exist are in the number of filters used.

Figure 1 shows the frequency response curves for the filter bank of the Sennheiser VSM 201 Vocoder. In this vocoder the frequency range of 100 Hz to 10 kHz is analysed into 20 separate channels using third-order bandpass filters. The same frequency response curves are valid for the filter bank in the synthesiser section.

In the case of the 'full-size' EMS vocoder, the filter bank consists of 20 fourth-order bandpass filters plus one high and one lowpass filter, which cover a spectrum of 200 Hz to 8 kHz (the centre frequencies are spaced at intervals of  $\frac{1}{2}$  octave). In the simpler EMS 200 vocoder there are 18 filter channels, the roll-off slope of each filter being 18 dB per octave.

## Voiced/unvoiced detector

This unit, which is present in all three models already discussed, has the job of deciding whether the speech signal is composed of voiced or unvoiced sounds and whether, at any given instant, the oscillator or the noise generator should be used for the excitation signal.

The way this circuit works is interesting. In the case of voiced sounds, the low frequency components of the signal are predominant, whilst in the case of unvoiced sibilants the reverse is true and

**The first part of this article provided a general overview of the basic principles of speech synthesis and vocoding. This second instalment takes a more detailed look at the various functional units of a vocoder, such as the filter bank, voiced/unvoiced detector and envelope followers, then goes on to discuss the wide range of possible applications in which the vocoder might be used.**

C. Chapman

there is a greater proportion of high frequency components in the speech signal. These differences can be detected by means of the circuit shown in figure 2 (this is the type of circuit used in the EMS vocoder), which consists of a high and lowpass filter feeding two envelope followers (filters preceded by a rectifier). The speech signal is therefore split into a higher and a lower frequency component, the amplitude characteristics of which are represented by the output voltages of the envelope followers. These are then compared, and depending on whether the speech signal contains a greater proportion of higher or lower frequencies, the output of the comparator will swing high or low respectively. In the case of unvoiced sounds the LED also lights up to indicate the switch from oscillator to the noise generator.

## Envelope followers

An envelope follower is present in each channel of the analyser section. As already explained, their function is to derive the control voltages which will be used to modulate the excitation signal. The output voltages of the envelope followers correspond to the varying amplitude levels of each channel of the input signal, and thus represent a real-time spectrum analysis of the speech.

An example of a typical envelope follower circuit is shown in figure 3. An active full-wave rectifier is followed by a 6 dB lowpass filter. The break frequency is determined by the time constant  $RI/CI$ , and is in the region of 100... 200 Hz.

## Silence bridging

Once again, all the above vocoders incorporate this useful facility. If no speech signal is presented to the vocoder input, as is the case during pauses in speech, then, naturally enough, in the absence of any control voltages there can be no output signal.

In order to prevent unpleasant staccato effects, silence bridging (sometimes known as 'pause stuffing!') must be used. Depending upon the vocoder, a bridging signal, which is derived either

The author and editor wish to thank Mr. Orr of EMS Ltd., Mr. Buder of Sennheiser and Mr. Funk of the Hamburg Radio Studio for their assistance in the preparation of this article.

1

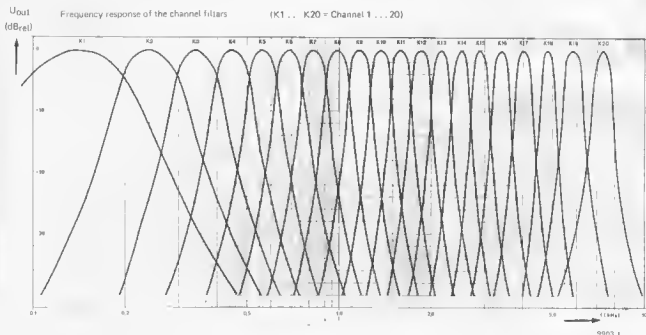

from the original speech signal of from the excitation signal, and the amplitude, harmonic content and attack and decay times of which can be varied, is mixed into the pauses, thereby providing an audible output signal.

#### External control

In the case of the large EMS vocoder, the connections between the output of the envelope followers and the VCAs are not fixed, but can be transposed at will, thus affording the possibility of producing some highly unusual and 'weird' sounds.

In both EMS vocoders nearly all the control voltages can be varied by externally derived common signals. The slew limiter shown in figure 4 (this corresponds to the portamento control in a music synthesiser) smooths out the changes in control voltage, so that, instead of the pitch of the output signal varying in a series of discrete steps, it can be made to slide continuously up and down the scale in the fashion of a slide trombone. The same circuit also provides a freeze control, which, when activated by a switch, will sample the control voltage at any given moment and hold it constant.

#### Additional facilities

The large EMS vocoder in particular contains a number of interesting additional facilities.

Mention has already been made of the two VCOs which can be played via an external keyboard, and these can also be used in conjunction with the 'pitch

extractor'. The latter is basically a pitch-to-voltage converter which functions by reading the glottal pulses of the speech signal. The control voltages from the output of the pitch extractor are fed to one or both of the VCOs, so that these follow the cadences of the speech signal, whilst there is also a 'quality' control which allows the pitch voltage to be exaggerated for special effects. In addition, the large EMS vocoder includes a frequency shifter which can vary the frequency of the input signal over a wide range ( $\pm 0.05$  Hz to  $\pm 1000$  Hz). In the case of the Sennheiser VSM 201, the frequency shifter is available as an optional extra, and can be connected to either the speech- or excitation signal input.

#### Detailed block diagram of the VSM 201 Vocoder

By taking a detailed look at the block diagram of one particular vocoder, i.e. the Sennheiser VSM 201, it should be possible to see just how the various functional units described above actually work together in practice.

Although at first sight the block diagram published in the first part of this article may not prove easily recognisable, at least the channel structure of the vocoder will be apparent from this drastically simplified (!) diagram of the VSM 201 (see figure 5). The main difference between this and the earlier diagram is the presence of the additional blocks labelled 'Filter Controls', 'Silence-Bridging Controls' and 'Channel Level

Controls', plus the fact that in the VSM 201 the relative positions of the modulators (VCAs) and filters in the synthesiser section are reversed.

The function of the filter controls is simple enough to explain: the output level of the 20 analyser filters can be varied by means of potentiometers PM1 ... PM20, the resulting signals can then be summed and fed direct to the vocoder output via switch SM. Thus by opening switch SV and closing switch SM the vocoder functions as a 20 channel equaliser - a useful facility for studio work. In addition, the filter controls and switch SM also allow an 'equalised' version of the speech signal (i.e. the level of each channel can be varied independently) to be added to the output of the vocoder (speech addition).

The controls PA1 ... PA10 enable the control voltage from the silence-bridging detector to be varied. There is one PA-control for every two analyser channels. The silence-bridging control voltage is fed to the envelope followers, where it is added to whatever control voltages are derived from the input speech signal. In this way a control voltage is still presented to the modulators in the synthesiser section even when there is a gap in the speech signal, so that these pauses are filled out by the excitation signal.

The 20 control voltages produced by the envelope followers are individually accessible via external sockets, whilst their level is indicated by a row of LEDs - two facilities which prove

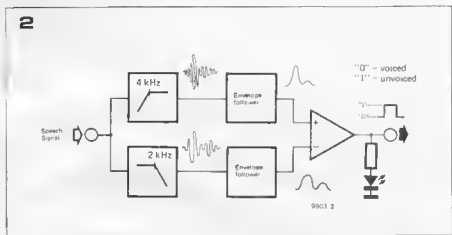

Figure 1. Frequency response of the channel filters in the Sennheiser VSM 201 vocoder. In this model the filter bank consists of 20 third-order active bandpass filters, the centre frequencies of which extend from 100 Hz to 8 kHz

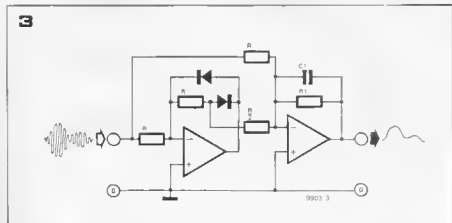

Figure 2. Block diagram of the voiced/unvoiced detector in a vocoder. The circuit is able to distinguish between voiced and unvoiced speech components by virtue of the differing proportions of high and low frequencies which they contain. The speech signal is divided into two frequency bands using a high and lowpass filter and the relative amplitudes of these two signals are then compared.

Figure 3. An envelope follower circuit consists of an active full-wave rectifier and a 6 dB lowpass filter. The time constant  $R1/C1$  determines the break frequency of the filter. The voltage at the output of the circuit follows the envelope of the input signal.

extremely valuable when operating the vocoder.

The reversed order of the modulators and filters in the synthesiser section is for developmental reasons and does not affect the synthesis of speech by the excitation signal. Photo 1 shows the traces of a control voltage and the ensuing signals along the synthesiser channel, and it can be clearly seen that there is no difference between this photo and that shown in the first part of this article (photo 7) where the modulators followed the synthesiser filter bank.

The signal level of each synthesiser-filter output can be varied by means of the channel level controls PV1...PV20, whilst by means of switch SV the vocoding section can be cut out completely. The control PG determines the output level, whilst the bypass signal path, which is controlled by PB, allows either a portion or all of the signal from the input variable gain amplifier to bypass the entire vocoder and be fed direct to the output amplifier.

#### Inputs and internal signal sources

Line and microphone inputs are available for both the speech and excitation signals. In addition, there are two extra line inputs for unvoiced excitation signals which can be used in place of the internal noise generator.

As far as built-in sound sources are concerned, the VSM 201 includes a pulse generator with a frequency of approx 150 Hz, which supplies an 'internal' excitation signal for test purposes

The noise source which is used to syn-

thesise the unvoiced portions of the excitation signal consists of a digital pseudo-random noise generator.

#### Voiced/unvoiced detector

The voiced/unvoiced detector in the VSM 201 analyses the input speech signal by feeding the control voltages from channel 0 (a separate lowpass filter and envelope follower) and channel 19 (centre frequency of the filter 5.8 kHz) to a comparator. The output of the comparator triggers the switch between the voiced and unvoiced excitation signal (VCOs or noise generator).

The process used to generate the unvoiced portions of the excitation signal deserves some attention, since the amplitude and spectral composition of this signal must be matched to the voiced portions. To ensure the correct amplitude characteristics, an envelope follower derives a control voltage from the voiced portions of the excitation signal, and this is used to suitably modulate the noise signal. A 'pink' filter, which can be switched in and out of circuit, is also included in the signal path of the unvoiced excitation signal, thereby allowing a 'colouration' of the noise.

#### Pause-detection and -bridging

In the VSM 201 pauses in the input speech signal are detected by comparing the amplitude of the speech envelope with a variable reference level, the speech/pause threshold. An envelope follower monitors the peak amplitude of the speech signal, the resultant control voltage being fed to a comparator

where it is compared against the preset speech/pause threshold voltage. The output of the comparator gates an analogue inverter which in turn provides the silence-bridging control voltage. The latter consists of the envelope voltage of the speech signal fed through a logarithmic amplifier.

Thus as soon as the comparator detects a pause in the speech signal, its output changes state and the full silence-bridging voltage takes over. The fact that the bridging control voltage is derived from the envelope voltage of the speech signal ensures that the level of the bridging signal corresponds to that of the speech signal, thereby preventing obvious jumps in the output level.

The silence-bridging circuit can be switched in and out by means of SA, whilst the inverted and non-inverted waveform from the output of the speech/pause comparator is available at external sockets. The presence of the latter waveform is indicated by a LED. Similarly, the envelope voltage of the speech signal is brought out to a socket for other control purposes.

#### Vocoder Applications

It is clear that the range of possible applications for the vocoder go far beyond the synthesis of speech; its musical potential however, is only now beginning to be fully appreciated. The most obvious application of vocoders is in the field of modern electronic music, and indeed a number of well-known artists and groups (e.g. Pink Floyd,

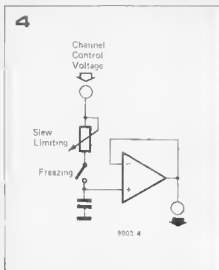

Figure 4. The slow limiter delays or smooths out the changes in control voltage in accordance with the setting of the potentiometer; when the 'freezing' switch is open, the circuit samples and holds the instantaneous control voltage. The circuit is situated between the analyser- and synthesiser sections in every vocoder channel.

Figure 5. A detailed block diagram of the Sennheiser Sound-Effect Vocoder VSM 201. When compared with the block diagram shown in the first part of this article (figure 3), it becomes apparent that additional control facilities and signal processing circuits (silence-bridging, voiced/unvoiced detector) account for a considerable proportion of the total circuitry. Although this block diagram may appear extremely complicated, it does in fact represent a heavily simplified view of what goes on 'inside' the vocoder.

Photo 1. In the case of the Sennheiser vocoder, the excitation signal is fed first to the modulators (VCAs), and then to the synthesiser filters. The progression of signals shown in these traces reveal that this arrangement has no effect upon the character of the synthesised speech signal. The letter is identical to the signal produced when the excitation signal is first divided into a number of frequency bands and these are then modulated by the channel control voltages.

The order of the signals is:

- A: Channel control voltage (channel 6 of the VSM 201).
- B: Excitation signal.
- C: Excitation signal in synthesiser channel 6 after it has been modulated by A.
- D: The above signal after it has been through synthesiser filter in channel 6.
- E: Vocoder output signal.

1

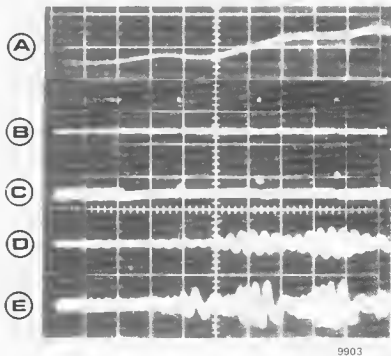

9903

Tangerine Dream, The Who etc.) have already recognised the enormous musical potential of vocoders. The versatility of the vocoder stems largely from the wide variety of different musical instruments with which it can be interfaced, and it is the ability of the vocoder to modulate the sound of 'conventional' instruments such as organs, guitar, drums etc., thereby providing totally new tonal possibilities, which lends the vocoder its unique character. It therefore seems likely that, in years to come, the vocoder will play a permanent role in the production of electronic music, especially when used in conjunction with a music synthesiser.

#### Vocoder and music synthesiser

When a vocoder is linked to a synthesiser, the tonal possibilities are virtually endless, since in a sense the two instruments are complementary. Despite the considerable versatility of a synthesiser, many musicians feel that it would be nice to have more control of the synthesised sound, e.g. be able to modulate the synthesiser signal with the variety of sounds which can be obtained from conventional musical instruments. To realise this, the synthesiser requires additional circuitry to analyse the external signal and convey its musical parameters to the synthesiser, i.e. a pitch to voltage converter to extract the melodic content, a vocoder to determine tone colour, and an envelope follower to con-

trol the amplitude characteristics of the synthesised signal.

The *pitch to voltage converter*, which can be viewed as the reverse of a VCO, enables the VCOs in the synthesiser to follow the frequency of an external input signal, such as e.g. that of an electric guitar. One is therefore no longer restricted to the compass of the keyboard, and the synthesiser can be 'played' by other musical instruments, and even by the sound of the human voice.

The *vocoder* tailors the harmonics of the synthesiser VCOs in a manner which is dependent upon the harmonic content of the instrumental or speech signal, so that feeding the output of the synthesiser VCOs to the excitation input of the vocoder results in it acquiring a similar tone colour to that of the signal fed to the speech input. The VCO waveforms which are rich in harmonics, e.g. the sawtooth and squarewave, are particularly suitable excitation signals for the vocoder, since their spectrum is sufficiently broad to reproduce most of the changes in harmonic content of the speech signal. The vocoder can be incorporated as a module into the synthesiser, replacing the position of the VCFs in the signal path.

Finally *envelope followers* can be used to vary the amplitude characteristics of the synthesiser signal in accordance with those of the external speech or guitar signal, so that the two will have a similar attack and decay etc.

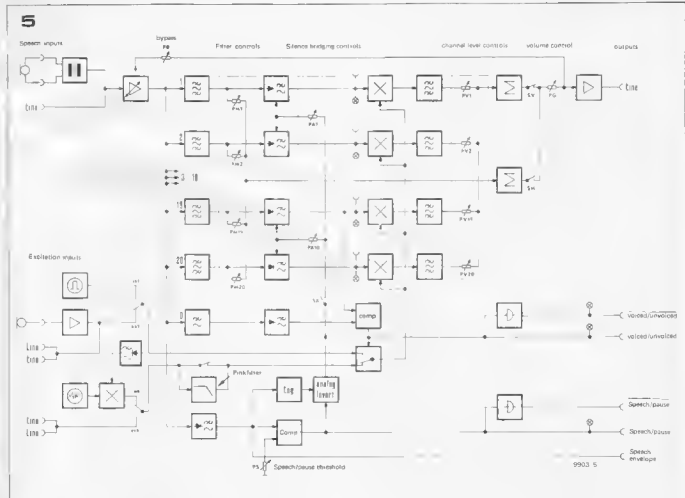

The combination of a large synthesiser and the above three devices opens up a world of virtually limitless musical possibilities. For example by restricting the synthesiser to the frequency range of the human voice, conventional instruments can be made to sound as if they are being played by a synthesiser — a particularly impressive effect if the sequence from the synthesiser is very fast. Another idea is to let the pitch of certain synthesiser VCOs follow the chords of e.g. an electric guitar which are spaced at intervals of say an octave, whilst others produce a continuous choral effect, this being made to 'sing' a spoken text presented to the speech input of the vocoder.

Although these are only examples, they appear to justify the conclusion that the combination of synthesiser and vocoder finally offers what many synthesiser manufacturers have claimed, namely the ability to produce a virtually infinite variety of different sounds.

#### General artistic applications of vocoders

The applications for a vocoder are, however, by no means limited to the sphere of the recording studio and its use, in conjunction with a synthesiser, for the creation of electronic music. It also represents a versatile special effects unit which can be employed in radio and live drama as well as films to produce the impression of 'talking' objects, for instance, or simply to vary the sound of

the human voice.

The non-realistic and slightly 'otherworldly' nature of vocoded speech lends itself particularly to applications such as sci-fi and children's films or plays, where the elements of phantasy and imagination are predominant. Indeed it may even prove to be in this area of artistic use that the vocoder finds its most important application.

#### In conclusion

To summarise briefly therefore: as a result of the efforts of Sennheiser and EMS, the vocoder, which has been used for a number of years in the field of telecommunications, has been developed into a highly versatile and sophisticated instrument for the production of electronic music and special effects. Its basic mode of operation is to analyse any signal within the frequency range of the human voice (normally a speech signal) and impose the most important parameters of that signal (amplitude, changes in the harmonic content, and variations in pitch) upon a second (excitation) signal. In this way it is possible to make the excitation signal 'speak' or 'sing' with a remarkably clear and differentiated articulation.

From a technical point of view (noise performance, distortion etc.), the above vocoder models all satisfy the requirements for studio work, and together form a comprehensive range suitable for all possible applications. A particularly

attractive feature is their relatively compact size (with respect to the amount of circuitry they contain) and extremely ergonomic layout, so that the prospective user is not deterred by a confusion of controls which take an age to master.

The vocoder allows the user to mix music, speech and sounds together in a totally new way, the resultant effects being characterised by their highly original and 'fantastical' nature.

#### Literature:

- Funk, H.: *Künstliche Stimmen aus dem Vocoder?* *Fachblatt-Music-magazin*, Mai 1977, pp 47... 50.  
 Condron, N. and Ford, H.: *EMS Vocoder — an operational assessment*. *Studio Sound*, July 1977, pp. 96... 98.

#### Acknowledgements:

Photo 1, Figures 1 and 5: Sennheiser Electronic, Wedemark, Hannover. ■



Modifications to  
Additions to  
Improvements on  
Corrections in  
Circuits published in Elektor

#### Moving coil preamp, E36, April 1978.

Page 4 02:

In figure 4, in the component layout, capacitor C20' (not C20) is shown connected backwards. The negative capacitor lead should connect to the left (L) output terminal and R23'.

If the regulator circuit shown in figure 3 cannot supply sufficient current, owing to component tolerances, the value of R29 should be reduced to  $6\Omega$ .

In the text under 'power supply' it was mentioned that a suitable power supply could be constructed using only a few components. This power supply is shown below

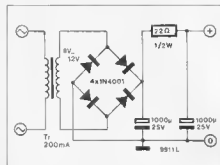

#### Elaktornado, April 1978, E36, page 4-07.

In figure 3 and on the PCB layout, four resistors were omitted. A  $220\Omega$  resistor should be connected in series with the base leads of transistors T1, T1', T2, T2'. Caution: before switching on the amplifier for the first time, make sure that the 'quiescent current' pots P1 and P1' are set fully counter-clockwise. Then follow the adjustment procedure given in the article; note, however that a lower quiescent current of say 30... 50 mA will be sufficient. ✦

The circuit was originally designed to automatically switch off a coffee percolator after a certain time, and as such has been functioning satisfactorily for quite a while here at the Elektor offices. The operating principle is simple:

After pressing the start button (S1), capacitor C2 is charged up to almost the full supply voltage, and the non-inverting input (pin 3) of IC1 is taken positive of the inverting input (pin 2), the latter being held low via the voltage divider R2/P1/R3. The output of IC1 therefore turns on T1, which in turn triggers triac Tr1. LED D3 will light up to indicate that the device in question (RL) is switched on.

As soon as the button S1 is released, C2 begins to discharge via the non-inverting input of IC1. After a certain interval, the length of which is determined by the value of C2 and R6 as well as the position of P1, the voltage across C2 will drop to below that at the inverting input (this being set by P1). The output of IC1 therefore drops to almost zero, turning off both T1 and Tr1, and the LED is extinguished, thereby indicating that the load device has been switched off.

If one wishes to switch off the device earlier than was originally intended, this can be done simply by pressing the stop button S2, which causes C2 to be discharged rapidly via R4.

Since C2 cannot have too high a value (it must be a low-leakage capacitor and therefore not an electrolytic), very long timing intervals can only be achieved by giving R6 an extremely high value. Although this is not a major problem, it is slightly inconvenient, since such high value resistors cannot be obtained individually and one is forced to use a number of smaller resistors connected in series.

With the value of C2 as given in the circuit diagram ( $2\mu\text{F}$ ), the maximum possible value for R6 is  $40\text{M}$ . This gives a maximum timing interval (which is set by P1) of 4 hours. It should be mentioned that the exact delay time will depend upon the tolerances of some of the components. If very long times are in fact required, it may be necessary to choose a slightly higher value for C2. Times of up to 1 hour are possible when

## percolator switch

Most of the timer ICs which are commonly available provide only relatively short timing intervals. If longer delays, of say, from several minutes up to a few hours, are required then one is faced with something of a problem.

The following circuit, which can be used in any number of possible applications (e.g. as a time switch for cookers, heaters, alarms, house lighting, etc.), permits delay times of up to approximately four hours.



1

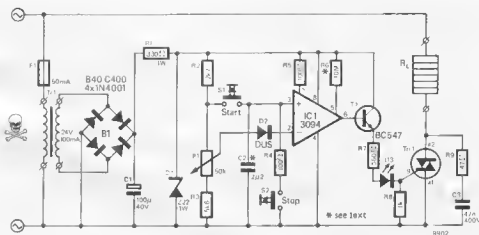

2

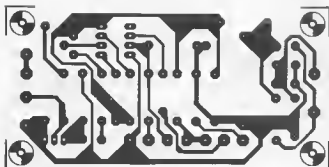

EPS 9902

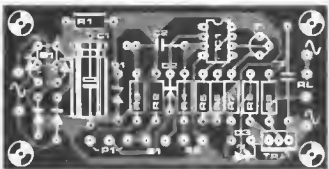

component values shown in the circuit diagram are used. The printed circuit board is designed to accommodate a CA 3094 in a mini-DIP package (a TO-version could also be used), whilst either a bridge rectifier or four discrete diodes may be used for B1.

The skull and crossbones beside the circuit diagram should be a clear enough indication that the circuit operates at dangerously high voltages, and therefore great care should be taken during construction. The circuit should be mounted in a fully insulating (plastic) case. If however a metal enclosure is used, then it should be connected to mains earth via a three core cable, and

the circuit itself insulated from the box. To further eliminate the possibility of electric shock, the pushbutton switches should be of a good quality type, suitable for mains use.

#### Selecting a triac

The selection of the triac will depend on the intended application. To avoid exceeding the PIV rating (peak inverse voltage) of the triac, a 400 V unit should be used. The current rating will depend upon the load which is to be switched. For loads such as lamps and heating elements, the switch-on

#### Parts list.

##### Resistors:

- R1 = 330 Ω/1 W
- R2 = 2k7
- R3 = 5k6
- R4, R5 = 100 Ω
- R6 = 10 M (see text)
- R7 = 560 Ω
- R8 = 1 k
- R9 = 47 Ω

##### Capacitors:

- C1 = 100 µ/40 V
- C2 = 2µ2 (MKH low leakage)
- C3 = 47 n/400 V

##### Semiconductors:

- IC1 = CA 3094 (RCA)
- T1 = BC 547
- Tr1 = 400 V triac (see text)
- D1 = zener diode 22 V/1 W
- D2 = DUS
- D3 = LED
- B1 = bridge rectifier B 40 C 400, or 4 x 1N4001

##### Miscellaneous:

- Tr1 = mains transformer  
24 V/100 mA
- F1 = mains fuse 50 mA (slow blo)
- P1 = potentiometer 50 k lin.
- S1, S2 = pushbutton switch,  
adequately insulated

'surge current' is usually quite a bit larger than the steady operating current. Therefore, if a 2 A device is being switched, it is advisable to use a 100% (or more) over-rated triac (4 A). In this connection, it is interesting to note that there is often very little difference in price between triacs with a low current rating and those with a high rating. For this reason, it is wise to purchase one with a large current rating, say 8 or 10 A, and not have to worry about accidentally 'blowing up' an under-rated slightly cheaper triac.



# colour modulator

When used in conjunction with a monochrome video signal generator the colour modulator can produce a four-colour video output. To convert a particular monochrome video signal, such as the playing field of a TV game, it is simply fed to the appropriate colour input. The hue of the resultant picture is determined by the relative proportions of the monochrome signals which are fed to the different colour inputs.

## The colour video signal

One of the most important requirements of a colour video signal is that it must be monochrome-compatible, i.e. a black and white receiver must be able to process it into a good quality monochromatic picture. For this reason a colour signal in actual fact consists of a separate monochrome video signal to which the colour information is added by modulating it onto a subcarrier.

The composition of the colour signal is fairly complicated, since it must contain all the field- and line sync signals present in the monochrome signal, plus the necessary colour information.

As is well known, any particular colour can be constituted by mixing the appropriate proportions of the three additive primary colours, red, green and blue, and this principle is utilised in the encoding of colour video signals. The colour TV camera has a separate output for each of the primary colours. These output voltages ( $U_r$ ,  $U_g$  and  $U_b$ ) are processed to provide a luminance signal  $U_y$  which supplies the monochrome video signal for black and white receivers. The luminance signal actually consists of the three primary colour outputs mixed in the proportions:  $0.3 U_r + 0.59 U_g + 0.11 U_b$ , which correspond to the primary components of the picture in monochrome.

The colour information is transmitted in the form of *colour-difference* signals,  $U_r-U_y$ ,  $U_g-U_y$  and  $U_b-U_y$ , which when summed together with the luminance signal will restore the three primary colour signals.

Since it is clear that any of the colour-difference signals can be derived from the luminance signal and the other two colour-difference signals, in practice

By comparatively simple means it is possible to extend a circuit which generates a monochrome video signal so as to add the extra dimension of colour.

The colour modulator described in the following article can be used with, for example, a monochrome TV games circuit such as that from the last Summer Circuits issue, to provide a composite colour video signal which can be fed direct to any UHF modulator.

only the  $U_r-U_y$  and  $U_b-U_y$  signals are transmitted. However to prevent the video carrier from being overmodulated, the  $U_r-U_y$  and  $U_b-U_y$  signals are attenuated to 0.877 and 0.493 of their original value before transmission, and are known as weighted signals.

The red and blue colour difference or *chrominance* signals are then amplitude-modulated onto a 4.43361875 MHz subcarrier in *quadrature*. A quadrature-modulated signal can be represented as the sum of two amplitude-modulated carrier which are  $90^\circ$  out of phase with one another. The resulting colour subcarrier is then suppressed before transmission, leaving only the upper and lower sidebands which are added to the  $U_y$  modulation on the main carrier.

Without delving too deeply into the theory, figure 1 illustrates the process of quadrature modulation and subcarrier suppression. For the sake of clarity, the blue ( $U_b$ ) and red ( $U_r$ ) colour-difference signals are assumed to be a sine- and squarewave respectively. Figures 1d and 1e show those signals modulated on the two ( $90^\circ$  out of phase) carriers. As can be seen, the resulting waveform (figure 1a) is the result of summing the latter signals.

It will be apparent that detection of the chrominance signal sidebands at the receiver demands great precision. A separate unmodulated subcarrier, which has the same frequency and phase as the suppressed colour subcarrier is generated by a local reference oscillator. This reference carrier is not in fact reinserted in place of the original (suppressed) subcarrier, but is used as a timing device. The chrominance sideband signal is sampled at the peaks of the reference or sampling 'carrier' and the result is a signal which exhibits the original chrominance modulation. This process is known as synchronous detection.

It is essential that the signal from the local reference oscillator be phase-locked (and hence frequency-locked) to the suppressed subcarrier. This is achieved by inserting 10 cycles of the subcarrier frequency, the so-called *colour-burst* signal on the back porch of the line sync pulses of the encoded colour signal at the transmitter (see figure 2). These colour bursts are extracted after detec-

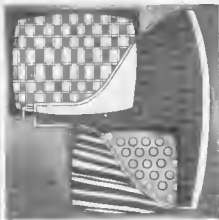

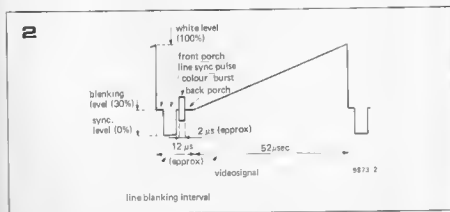
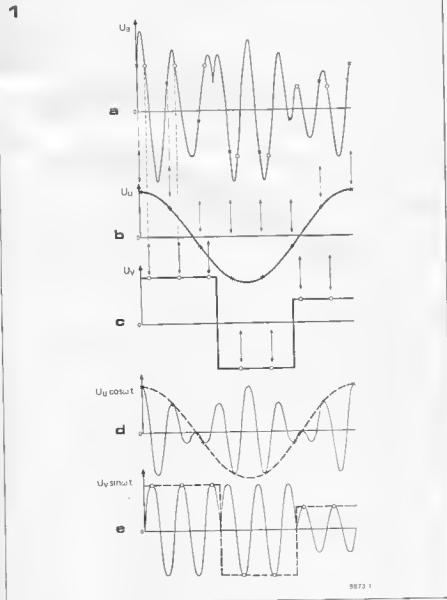

Figure 1. An illustration of quadrature modulation. Figure 1a shows the quadrature-modulated chrominance subcarrier  $U_a$ . 1b and 1c represent the two colour difference signals  $U_u$  and  $U_v$  which are modulated onto the subcarrier, whilst 1d and 1e show how these signals are modulated onto subcarriers which have a phase difference of  $90^\circ$ . Figure 1a is obtained by adding figures 1d and 1e.

Figure 2. One line of the composite video signal. The colour burst is inserted approx.  $0.5 \mu\text{s}$  after the line sync pulse.

tion at the receiver and fed to a phase discriminator which compares the burst with a quartz reference oscillator. If the reference oscillator is not precisely in phase with the burst, a DC voltage is generated and is applied to the reference oscillator in such a way as to bring it into phase. In a normal TV receiver, if the two signals cannot be brought into phase a circuit known as the *colour killer* switches the receiver into a black and white mode. If the colour killer was

disabled and the reference oscillator was not locked with the burst the colours on the screen would appear to drift through the colour spectrum. This drift would be at the same rate as the difference frequency between the burst and reference signals.

### The PAL system

The chrominance modulation has components which vary both in amplitude and phase as the colour information changes. The amplitude components relate to saturation, whilst the phase components determine hue. For this reason colour sets are phase-sensitive, i.e. a change in the phase of the signal during transmission can adversely affect the accuracy of the colour reproduction at the receiver.

The American NTSC system is particularly sensitive to changes in phase, however the PAL system which is currently used in Great Britain and most of Europe (with the notable exception of France) has successfully managed to overcome these problems. Differences in the phase of the red and blue colour-difference signals are corrected by reversing the phase of the red chrominance signals on alternate lines (hence the name PAL, meaning Phase Alternate Line). Thus if there is a colour error on one line it is cancelled out by a complementary error on the next line, the overall result being a correct hue display even if there is a relatively high phase error.

There are basically two different ways of ensuring correct hue integration at the receiver. In the simple PAL system (or PAL-S) this is done subjectively: at a certain distance the eye itself integrates the differences between successive lines, giving the impression of a satisfactory colour picture. The second and more common method (used in PAL II or PAL D, and PAL III) is to use a delay line in the receiver to store the colour information of one line and release it during the next line, along with the information of that second line.

An essential feature of the PAL system is the *PAL-switch*, which ensures that the phase of the red colour difference signal is reversed on alternate lines before it is fed to the quadrature modulator. In the demodulator the PAL-switch is responsible for correcting the phase of  $U_v$  to its original polarity. The PAL-switch in the demodulator is controlled by the colour-burst signal, since it is the phase of the latter which determines the position of the switch see figure 3.

### The colour modulator

As is apparent from figure 4, the design for a simple PAL-compatible colour modulator need not be as complicated as one might at first imagine.

A crystal oscillator is used to generate the chrominance subcarrier, XTO, from which the inverted (i.e.  $180^\circ$  out of phase) form,  $\bar{X}TO$ , is derived. The two

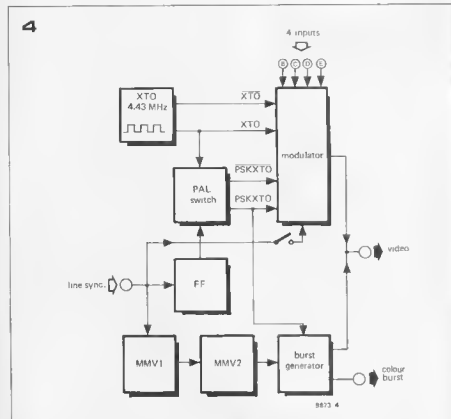
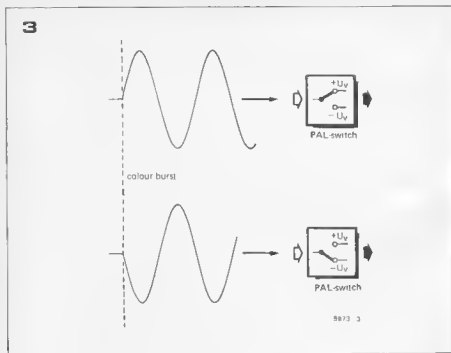

signals  $X_{TO}$  and  $\bar{X}_{TO}$  supply the sub-carrier onto which the blue colour difference signal  $U_B$  is modulated. The sub-carrier onto which the red chrominance signal  $U_R$  is modulated (PSKXTO and PSKXT0) is also derived from  $X_{TO}$ . PSKXTO stands for 'phase shift keyed crystal oscillator'. As already explained, the PAL-switch ensures the reversal of this latter sub-carrier (with this type of modulation, reversing the sub-carrier has the same effect as reversing the phase of the modulating signal). The PAL-switch is gated by a flip-flop FF, which in turn is triggered by the line sync pulse. The necessary difference in phase between

the blue and red chrominance signals is obtained by the - very slight - delay introduced by the logic gates and by an RC network.

The four waveforms derived from the crystal oscillator ( $X_{TO}$ ,  $\bar{X}_{TO}$ , PSKXTO and PSKXT0) are fed to the modulator proper, which has four video inputs. The output is a composite colour signal modulated onto a 4.43 MHz sub-carrier. The colour burst, the phase of which is reversed on alternate lines, is derived from the PSKXTO signal. The phase of this latter signal is likewise inverted by the PAL switch

The burst generator is triggered by a

monostable, MMV2, which ensures that the colour burst has the required duration of approx. 2  $\mu$ s. This monostable is in turn triggered by MMV1, so that the burst is inserted at exactly the correct moment, i.e. approx. 0.5  $\mu$ s after the line sync pulse.

### The circuit

Figure 5 shows the complete circuit diagram of the colour modulator. As is apparent the circuit uses no more than six IC's, one crystal and a small amount of discrete components.

The oscillator which generates the 4.43 MHz subcarrier is constructed in the usual fashion using TTL gates. The crystal is a 4.434 MHz type as used in colour TV sets. Almost any cheap surplus TV crystal will work. The exclusive-OR gate N8 forms the PAL-switch, and is thus responsible for reversing the polarity of the subcarrier. When one of the EXOR inputs is low, the signal at the other input is fed unaltered to the output. However, if one of the inputs goes high, then the other input signal is fed to the output in its inverted form (see figure 6).

As a result of the propagation delay of N8 and the RC network C7-R10-P1, a phase difference of 90° is introduced between the red chrominance signal  $U_R$  (PSKXTO and its inverse) and the blue chrominance signal  $U_B$  ( $X_{TO}$ ,  $\bar{X}_{TO}$ ).

The actual colour modulator simply consists of four logic gate circuits (N11...N18). The modulation itself, i.e. the presence or absence of the inverted subcarrier, is determined by the logic level at the four inputs B...E. The diodes D1...D4 protect the modulator against voltage transients, whilst D5...D8 form a simple OR gate which combines the four output levels of the modulator gates.

The colour burst, which as already explained consists of 10 cycles of sub-carrier frequency, is taken from the signal at the PAL-switch, N8. Flip-flop FF2 is employed in a somewhat unusual configuration. By connecting the Q-output with the clear-input, the flip-flop will clear itself each time it is set by a clock pulse, unless the preset-input is low. Capacitor C6 ensures a certain delay, so that the duration of the pulses at the flip-flop output is not too short. The flip-flop therefore functions more or less as a gate: when the preset-input is high, a pulse train which has the same frequency as that of the clock pulses is present at the Q-output. The preset-input is high during the colour-burst period, the latter being triggered by the two monostables (MMV1 and MMV2) which constitute IC3. The fact that a flip-flop is used instead of a normal gate in the colour-burst generator has a prosaic explanation: it simply saves an IC.

The burst signal is inserted into the composite video signal via gate N9 and capacitor C8, and is also individually accessible at output 3. The line sync

5

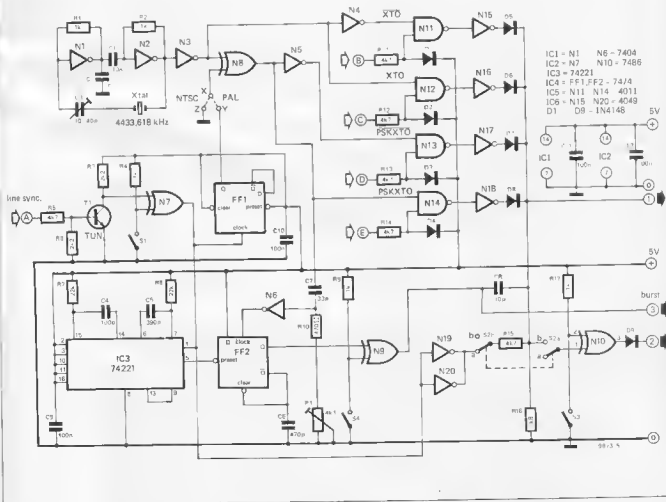

Figure 3. The phase of the colour burst signal controls the PAL-switch in the TV receiver.

Figure 4. Block diagram of the colour modulator. The circuit has four inputs (B...E) to accept colour information.

Figure 5. The complete circuit diagram of the colour modulator.

Figure 6. The exclusive OR gate used as a polarity switch. It is apparent from the truth table that A is fed unaltered to the output when B = 0; if B = 1, then C = A.

present any special problems. For normal use points X and Y should be joined. If point X is earthed (i.e. joined to Z), then the PAL-switch will cease to function and the circuit will supply a colour video signal suitable for an NTSC set. (Note: if this circuit is to be used with an NTSC set the crystal should be a U.S. color xtal 3.58 MHz).

The circuit requires a supply voltage of 5 V, and consumes approx. 130 mA.

The setting up procedure is as follows: The black and white video signal generator with which the colour modulator is to be used (CCIR pattern generator, TV games circuit etc.) should be functioning satisfactorily and tuned to an unoccupied (UHF) channel. The colour TV receiver is then tuned to the above device such that the reception is fairly critical, i.e. the receiver is tuned to one of the sidebands; the contrast of the picture should then be fairly low.

The next step is to connect the colour modulator to the monochrome signal generator (see later in this article) and feed in two or more input signals to points B...E. Using an insulated screwdriver or similar non-metallic object, trimmer C3 is adjusted until a colour picture is obtained. The colour may be very faint and washed-out, but will improve when the receiver is cor-

6

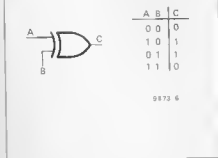

signal which is fed to the input, is also added to the output signal after being buffered by the parallel-connected gates N19 and N20. This function can be disabled by means of switch S2.

The polarity of the various signals can be reversed by means of the combinations of switches S1/N7, S3/N10 and S4/N9. The position of S1 is determined by the application of the circuit, whilst S3 and S4 affect the colours of the picture.

### Construction and setting up

Mounting the circuit on the printed circuit board (see figure 7) should not

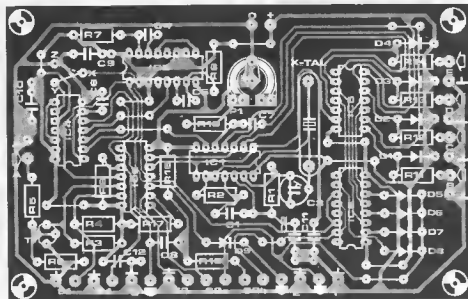
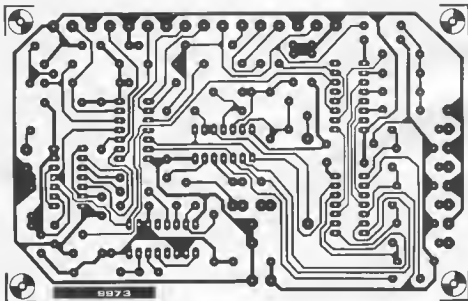

## Parts list to figure 7

## Resistors:

R1,R2,R4,R9,R17 = 1 k  
 R3,R6 = 2k2  
 R5,R11,R12,R13,R14,R15 = 4k7  
 R7,R8 = 22 k  
 R10 = 470  $\Omega$   
 R16 = 1k8  
 P1 = 4k7 preset

## Capacitors:

C1 = 10 n  
 C2 = 1 n  
 C3 = trimmer 10-40 p  
 C4 = 100 p  
 C5 = 390 p  
 C6 = 470 p  
 C7 = 33 p  
 C8 = 10 p  
 C9,C10,C11,C12 = 100 n

## Semiconductors:

D1 .. D9 = 1N4148  
 T1 = TUN  
 IC1 = N1 .. N6 = 7404  
 IC2 = N7 .. N10 = 7486  
 IC3 = 74221  
 IC4 = FF1, FF2 = 7474  
 IC5 = N11 .. N14 = 4011  
 IC6 = N15 .. N20 = 4049

## Miscellaneous

crystal: PAL = 4.43 MHz colour  
 TV xtal, series resonant 25-30 pF,  
 NTSC = 3.58 MHz U.S.  
 color TV xtal series  
 resonant 25-30 pF.  
 S1,S3,S4 = single-pole-switch  
 S2 = DPDT switch

Figure 7. Printed circuit board and component layout for the colour modulator (EPS 9873).

Figure 8. A section of the circuit diagram of the TV games generator published in the last Summer Circuits issue (circuit 44). The circuit is coupled to the colour modulator via the new connection points P...S, 'line sync' and 'video in'. The dotted lines indicate components which should be omitted - see text.

Figure 9. The connections between the colour modulator and the CCIR pattern generator.

rectly tuned. When adjusting C3 it is best to set preset P1 to one (it does not matter which) of its end stops.

Once the trimmer has been adjusted and the television receiver tuned properly, there is a good chance that a regular interference pattern will appear on the screen. This is caused by crosstalk between the various subcarriers, and can be minimised by adjusting P1. It will be noted that this also has an effect upon the colours of the picture.

The hue of the resulting colours is determined by the nature of the signals presented to the four inputs B...E, or rather, by the differences between these signals. A colour video signal will only be obtained if at least two different signals are fed to the modulator. Thus it is not necessary that a signal be presented to all four of the inputs, nor is it a problem if two or even three of the input signals be the same.

Basically the colour modulator is suitable for all types of games applications. However its performance in terms of stability and quality of colour, allied to the fact that it cannot supply a picture containing just one of the primary colours, renders it unsuitable for test or measurement purposes. For this reason, connecting it to the CCIR generator has only limited usefulness.

### Using the modulator with the TV games circuit from the Summer Circuits issue

The modulator is particularly suited for use with the AY-3-8500 TV games chip published in the 1977 summer circuits issue (circuit 44). The relevant section of the circuit is reproduced in figure 8. The line sync signal for the colour modulator (point A) is taken from pin 2 or pin 4 of IC2. R3 and R4 in the TV games circuit should be omitted.

The four remaining outputs P...S of IC2 (pins 6, 10, 12 and 15) each represent a component of the games picture (the two bats, ball and playing field) and should be connected to the four inputs B...E of the colour modulator. Which output of the games generator is connected with which input of the colour modulator is not important, and only determines what colour the various picture components will have. Diodes D1...D4 in the games circuit should also be omitted.

The output of the colour modulator (output '1' in figure 5) should be connected to the point labelled 'video-in' in figure 8. For use with the games generator switch S1 in the modulator should be closed, and S2 in position a. If desired both these switches can be replaced by fixed connections. The position of S4 determines the colours.

### Using the modulator with the CCIR pattern generator

The colour modulator can also be used in conjunction with the CCIR pattern

8

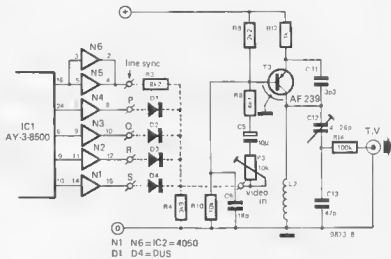

N1 N6 = IC2 = 4050

D1 D4 = DUS

9

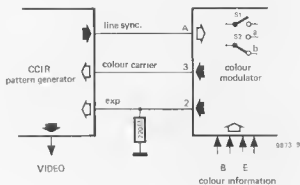

generator published in Elektor 29-31, despite the fact that, as already mentioned, the modulator is less suited to test and measurement applications.

To connect the two, point A of the colour modulator circuit should be joined to the line sync output of the pattern generator. The colour burst output of the modulator (output 3) is connected to the 'colour carrier' input of the pattern generator and output 2 to the point 'exp' of the generator. In addition a 220 Ω resistor is included between this connection and earth. The VIDEO-output of the pattern generator remains the video output for both circuits; the four inputs B...E of the colour modulator are extra TTL-compatible inputs for colour information.

When used with the pattern generator, S1 should be open and S2 in position b. Figure 9 shows all the necessary connections between the modulator and pattern generator. Connection can be simplified by omitting the two monostables (IC3) in the colour modulator. The preset-input of I-F2 can then be controlled directly by the 'burst-enable' output of the pattern generator.

For an interesting colour display, the colour information inputs B...E can be connected to 'horizontal bar' outputs of the test pattern generating section in the CCIR generator. M

# circuit boards and soldering

## Printed circuit boards

What exactly is a printed circuit board? Well, basically it is an insulating substrate on which components are mounted, and to which are bonded copper conductors in the required circuit interconnection pattern. A typical printed circuit board starts life as a piece of 'copper laminate board'. This is a sheet of synthetic-resin-bonded paper (SRBP) or epoxy-bonded fibre glass, to which a continuous coating of thin copper foil is fixed by adhesive. Once the required circuit connection pattern has been designed it is transferred to the copper surface in the form of an acid-resistant ink. The board is then immersed in an etchant solution that dissolves away the areas of copper not protected by the resist, leaving only the circuit track pattern. The resist is then cleaned from the board, holes are drilled to mount the components, the component leads are inserted through the holes and soldered to the copper tracks.

Professionally produced printed circuit boards can, of course, be considerably more sophisticated. As an aid to inserting components in the correct locations a component layout is frequently printed on the top face (non-copper side) of the board. The track pattern may also be printed, in ink, on the top of the board as an aid to circuit tracing. The copper side of the board may be completely covered with a 'solder mask', except for small areas around the holes through which the component leads protrude. This means that the copper track can only be soldered in the area of these 'pads', and the solder mask prevents accidental solder splashes from adhering to other areas of the board.

The pads themselves are frequently covered with a thin plating of tin, which aids soldering and prevents oxidation of the copper if the board is stored for some length of time before use. Alternatively a thin coating of a special lacquer may perform a similar function.

If a circuit is particularly complicated it may be impossible to make all the required interconnections on one side of the board, in which case a 'double-sided' board may be used, which has copper tracks on both sides of the board. To avoid the necessity of wire

links to make connections between the top and bottom of the board, 'plated-through holes' are often employed. This means that metal is electroplated through a hole from a pad on one side of the board to a pad on the other side. An interesting possibility offered by double-sided printed circuit boards is that components can be mounted on both sides of the board. Boards available from the Elektor Printed circuit board Service (EPS) are typical examples of current p.c.b. practice (see figure 1).

**Home-made p.c. boards**

Home production of all but the simplest p.c. boards involves considerable outlay and a fair amount of skill, which is why Elektor offers ready-made boards for many projects. However, it is appreciated that some readers will wish to 'have a go' themselves.

By far the most difficult aspect of printed circuit board production is the design, i.e. transforming a theoretical circuit into a practical p.c.b. layout. Unfortunately there are no hard and fast rules for this, and skill only comes with practice. The best plan is probably to study professionally produced layouts such as those in Elektor, and to build up one's skill gradually starting with simple circuits.

If a p.c.b. layout is already given then no design problem exists, and the design can be transferred to the copper laminate board.

First of all the board must be cut to the correct size. Then the copper surface must be scrupulously cleaned to ensure even etching. This can be done using a Brillo pad, wire wool and soap or an abrasive cleaner such as Vim or Ajax. After cleaning the board should be washed thoroughly to remove any traces of the cleaner and dried using a lint-free cloth.

To make a 'one-off' board for a not-too-complicated circuit the simplest method is to draw the layout directly onto the copper using an etch-resist pen such as a Decon Dalo-pen. For complicated shapes such as ICs, etch-resist transfers are available. These are simply rubbed off the backing sheet onto the copper.

links to make connections between the top and bottom of the board, 'plated-through holes' are often employed. This means that metal is electroplated through a hole from a pad on one side of the board to a pad on the other side. An interesting possibility offered by double-sided printed circuit boards is that components can be mounted on both sides of the board.

Boards available from the Elektor Printed circuit board Service (EPS) are typical examples of current p.c.b. practice (see figure 1).

## Home-made p.c. boards

Home production of all but the simplest p.c. boards involves considerable outlay and a fair amount of skill, which is why Elektor offers ready-made boards for many projects. However, it is appreciated that some readers will wish to 'have a go' themselves.

By far the most difficult aspect of printed circuit board production is the design, i.e. transforming a theoretical circuit into a practical p.c.b. layout. Unfortunately there are no hard and fast rules for this, and skill only comes with practice. The best plan is probably to study professionally produced layouts such as those in Elektor, and to build up one's skill gradually starting with simple circuits.

If a p.c.b. layout is already given then no design problem exists, and the design can be transferred to the copper laminate board.

First of all the board must be cut to the correct size. Then the copper surface must be scrupulously cleaned to ensure even etching. This can be done using a Brillo pad, wire wool and soap or an abrasive cleaner such as Vim or Ajax. After cleaning the board should be washed thoroughly to remove any traces of the cleaner and dried using a lint-free cloth.

To make a 'one-off' board for a not-too-complicated circuit the simplest method is to draw the layout directly onto the copper using an etch-resist pen such as a Decon Dalo-pen. For complicated shapes such as ICs, etch-resist transfers are available. These are simply rubbed off the backing sheet onto the copper.



Figure 1. Boards from the Elektor Printed circuit board Service are typical examples of modern p.c.b. practice.

1

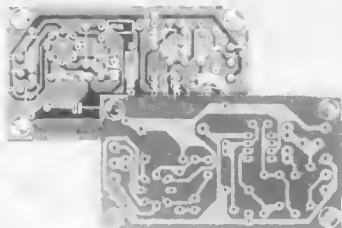

## Etching

Once the layout is complete the board is immersed in an etchant solution. Various exotic chemicals are used in industry, but for the home constructor ferric chloride remains the standard etchant. This is available in solution, either concentrated or ready for use, and the supplier's instructions should be followed. Ferric chloride is also available in crystalline form, in which case a solution must be made up. A suitable solution for etching is 500g of ferric chloride crystals to one litre of water. When making up the solution the crystals should always be added to the water, never the other way round. One litre of etchant is sufficient to etch 3000 to 4000 sq cm of board.

Ferric chloride is extremely corrosive and it is advisable to wear protective clothing such as rubber gloves and a plastic apron when using it. If ferric chloride comes into contact with the skin it should be washed off immediately. If it contacts the eyes these should be washed with copious amounts of cold water and medical assistance sought immediately.

All utensils used to contain ferric chloride should be of glass or plastic, never use a metal container. If it is to be stored for any length of time, the container must be air-tight. Ferric chloride is hygroscopic, which means that if given half a chance it will capture moisture out of the air until it overflows a normal container!

Etching can be speeded up by warming the solution. The easiest way to achieve this is to place the dish containing the etchant in a bowl of warm water. Whilst the board is in the solution it should frequently be agitated to bring fresh solution into contact with the copper and to dislodge the 'sludge' of iron that is displaced from the solution as the copper dissolves.

The board should be checked periodically to see how the etching is proceeding. It should not be left in the solution once etching is complete as the etchant will begin to undercut the edges of the copper track where the resist does not protect it.

Once the board has been etched the resist can be scrubbed off and holes for

the components can be drilled. The components should be mounted and soldered before the copper has time to tarnish, and the copper should be protected by a coat of lacquer immediately after the circuit has been tested. If the board is to be stored for some time before mounting components then it should be given a coating of special printed circuit lacquer, available from Doram. This is somewhat more expensive than ordinary decorative lacquers, but the board can be soldered through the lacquer, whereas ordinary lacquers inhibit soldering.

## Photographic methods

If several boards of the same design are to be made, or a complicated layout is to be copied from a magazine, then it is worth considering photographic methods. There are several ways of transferring a layout onto copper laminate board photographically.

The method for making a board from one's own layout design is to draft the layout onto transparent or translucent film (available from shops selling artists' materials) using black, self-adhesive draughting tapes and pads (available from Circuitepe or Doram). This is known as a positive master.

The cleaned copper laminate board is then coated with a positive photo-resist such as Fotolak, according to the manufacturer's instructions. The master artwork is placed in contact with the resist and the resist is exposed to light (which may be ultraviolet or visible light depending on the type of resist) through the master artwork.

The exposed board is then placed in a developer bath (or sprayed with developer depending on the type of resist) when the exposed portions of the resist (those not covered by the black track of the artwork) are developed away.

The board is then washed and etched in the normal way.

Negative photoresists are also available; if these are used then the unexposed portions of the resist are developed away. Of course, a negative photoresist entails the use of a negative master, i.e. a black background with transparent areas for the track pattern. This must be produced by making a contact print of the positive

master onto photographic film. Only readers who do their own photographic processing will have the necessary equipment, and it is not intended to discuss this method further.

Layouts printed in magazines may also be photographed, and the photographic negative can be enlarged to the correct master. Here again, readers who carry out photographic processing will know how to do this. Alternatively, any local photographer should be able to carry out this work for a modest charge.

## Soldering

Having purchased or made a printed circuit board, there is then the problem of making a reliable electrical (and mechanical) connection between the component leads and the copper tracks on the board.

Soldering involves the use of a metal that will melt at a relatively low temperature (usually about 200°C), which will form a molecular bond with the component leads and the copper track. The temperature must be fairly low since components are susceptible to damage by excessive heat, as is the adhesive used to bond the copper to the printed circuit board.

Electrical solder is an alloy of lead and tin. Pure lead melts at 232°C and tin melts at 327°C, but an alloy of the two metals, paradoxically, melts at a lower temperature than either of the constituents. The temperature at which the alloy melts depends on the proportions of the two constituents. The lowest melting point for a tin/lead alloy is 183°C, and is obtained when the proportions are 63% tin to 37% lead. An alloy with the lowest possible melting point is known as a eutectic mixture (Greek: eutēktos — easily melted). A eutectic alloy of tin and lead changes from a solid to a liquid at exactly 183°C. If the mixture is not eutectic then the alloy will not melt at exactly this temperature but will exhibit a range of temperatures where it has a 'plastic' consistency. This is shown in figure 2.

It is not a good idea to have solder with too large a plastic range. If the soldered joint is moved whilst it is cooling from the liquid state, through the plastic state to the solid state, this can result in the



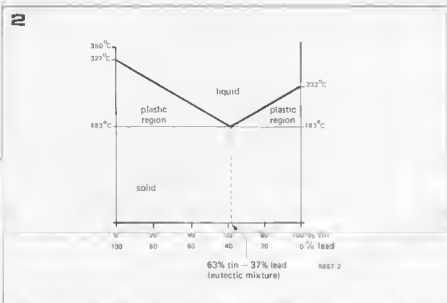

alloy solidifying with an extremely crystalline structure which has poor mechanical strength and high electrical resistance. The actual proportions of electrical solder are normally 60% tin to 40% lead. Small quantities of other metals are also added, such as antimony to improve mechanical strength.

Even this is not the whole story of solder, however. The component lead and p.c.b. track are covered with a layer of oxide that prevents the solder from 'wetting' the metal and forming a molecular bond. Even scrupulous cleaning of the board and component leads will not help, because an oxide layer only a few molecules thick will form instantaneously on a clean metal surface.

To enable soldering to be carried out, flux is required. This consists of an organic resin that improves the wetting properties of the solder and an activator that dissolves oxide. Electrical solder for general use is produced in the form of a wire of circular cross-section. The flux is an integral part of this wire in the form of three or more cylindrical cores of flux running down the centre of the solder, as shown in figure 3.

To make a soldered joint the components to be joined (e.g. a component lead and circuit board pad) are heated simultaneously with a soldering iron to a temperature higher than the melting point of the solder. The solder wire is then fed into the joint, not to the soldering iron as the excessive heat will vapourise the flux too quickly and will cause the solder to oxidise.

At about 160°C the flux becomes active and cleans the surface of the components. At around 200°C the molten solder displaces the flux from the metal surfaces and wets them, forming a molecular bond. The soldering iron is then removed and the joint is allowed to cool without moving it.

A good soldered joint should have a smooth, shiny appearance and a concave surface, and the solder should flow smoothly into the surface of the two components. Excessive amounts of

solder and large blobs with convex surfaces are signs of a poor joint. A cross-section of a good soldered joint is illustrated in figure 4.

When making electrical soldered joints, no flux is required other than that contained in the solder, and the use of acid-based fluxes, such as those used in plumbing and metalwork, should be avoided since they are corrosive and electrically conductive.

### Soldering irons

Soldering irons have come a long way since the days when they had to be heated up on a gas ring, and a large and bewildering range of types is now available.

The cheapest type of soldering iron, which will be perfectly adequate for the home constructor's purposes, is the continuous heat type. This typically consists of a thermally and electrically insulated handle, from which protrudes a stainless steel shaft containing a ceramic encapsulated electrical heating element. The business end of the iron — the 'bit' — is a hollow copper cylinder that slides over the shaft and is secured by a spring clip. The tip of the bit may be a variety of different shapes depending on the intended application, and a selection of different bits are shown in figure 5. Large bits are obviously used for heavy-duty work and small bits for fine work. The element of a continuous heat iron is connected permanently to the supply, and there is no control over the bit temperature. This means that the iron will cool down whilst actually making joints, since heat is drawn from it to heat up the joint and melt the solder, but it will become very hot when not being used. This can mean that the first joint made after the iron has been standing idle may be overheated. The problem can be reduced by using a metal stand for the soldering iron, which will act as a heat sink and will ensure that the iron does not become too hot whilst idle. Continuous heat irons are available in various wattage ratings, but for general



Figure 2. Illustrating the melting points of different alloys of tin and lead and the plastic region exhibited by non-eutectic mixtures.

Figure 3. Electrical solder has cores of flux running down the centre of it. No additional flux is required with this type of solder.

Figure 4. Illustrating the principal points of a good soldered joint.

1. p.c.b. substrate
2. copper layer
3. alloy of solder and copper track (only a few molecules thick)
4. solder
5. alloy of solder and component lead
6. component lead
7. The maximum angle the solder makes with the track should be less than 30°.

Figure 5. A selection of soldering iron bits.

Figure 6. When making a joint the component and pad should be heated with the soldering iron and the solder run into the joint, not onto the iron.

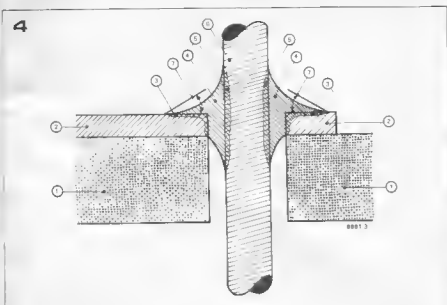

use a 20-25 W model, together with a selection of different bits, should prove adequate. If a great deal of fine work is to be undertaken then it may also be worth considering a 10-15 W model, and if any metal work is to be undertaken (e.g. screening enclosures for r.f. circuits) a 60 W iron will be useful.

The smaller wattage rating irons are often available in different voltage ratings. For general use a mains powered iron is probably the best bet, but if the enthusiast's interest involves outdoor work such as car electronics, mobile radio or field servicing then a 12 V iron may prove useful.

### Soldering iron bits

Soldering iron bits almost invariably used to be made of copper, since this is a good conductor of heat. However, each time a soldered joint is made a little copper dissolves in the solder, and eventually a copper bit becomes pitted and has to be filed down. Modern bits are generally made of copper, plated with some harder metal such as iron or nickel, which does not dissolve. These bits should never be filed, but should periodically be wiped on a damp sponge, while hot, to remove excess solder and dross.

Before using any bit for the first time, it must be tinned - coated with a fine layer of solder - to prevent oxidation and improve thermal contact with the joint when in use. The iron should be switched on and the solder held in contact with it. As soon as the solder melts it should be run over the entire tip of the bit. Any excess solder may then be wiped off.

### Soldering techniques

Having chosen a suitable soldering iron and the correct bit for the job, it is important to use solder of the correct diameter. If the solder is too thick it will be difficult to control the feed rate into the joint and the joint may become flooded with solder. On the other hand, if the solder is too thin then a much greater length must be fed into the joint and it will take longer to make each joint. Fine solder is also more expensive (per unit weight) than thick solder.

For general purpose use 18 SWG solder should prove adequate, and for fine work such as soldering ICs 22 SWG solder should be used.

When soldering components into a printed circuit board the following sequence should be adhered to:

1. Any terminal pins should first be inserted into the board.
2. Small, horizontally mounted components such as resistors and diodes should then be inserted into the board. During the soldering operation

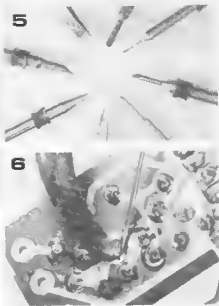

the board can be laid, component side down, on a piece of plastic foam, which will hold the components in place. Alternatively, the leads can be bent outwards at an angle of about 45° to hold the components in place.

3. When the components have been inserted into the board the leads can be cropped off fairly close to the board, using wire cutters.
4. To solder components, apply the tip of the iron to the component lead and the pad simultaneously and run solder onto both (see figure 6). When sufficient solder has run onto the joint remove the solder and the iron and allow the joint to cool.
5. The procedure can then be repeated for ICs or IC sockets, transistors and large or vertically mounted components.
6. To improve the appearance of the board any excess flux can then be removed with methylated spirit.

If components have to be removed from the board for any reason, this should be done with great care to avoid damaging the copper track. Grip one lead of the component to be removed with a pair of pliers, reheat the joint until the solder melts then pull the lead clear. Repeat for the other lead(s). To remove ICs it is best to use a 'solder sucker' to remove solder from every pin of the IC, thus leaving the IC free to be removed.

Before inserting a new component it is essential that all the holes should be free of solder. This can be ensured by using a solder sucker, or by heating up the pad and inserting a pencil point into the hole. The board should be allowed to cool completely before inserting the new component, as otherwise there is a danger of lifting away the copper track from around the hole due to weakening of the adhesive by heat.

If all the preceding recommendations are followed there is no reason why the constructor should not enjoy a high success rate when using printed circuit boards.

## universal logic tester

This logic tester can be used with both TTL and CMOS circuits as well as other logic families which exhibit similar characteristics. In addition to providing the usual logic 0 and logic 1 indications it will also indicate an undefined logic level and open circuit connections.

(J. Borgman)

In TTL circuits a voltage less than 0.8 V is defined as logic 0 or 'low', and a voltage greater than 2 V is defined as logic 1 or 'high'. A voltage between these two is referred to as an undefined logic level. CMOS logic is capable of operating over a much wider supply range than TTL, typically 3 - 18 V. The logic levels for CMOS are not defined as absolute voltages but as percentages of supply voltage. A high logic level is defined as greater than 60% of supply voltage, and a low level is defined as less than 40% of supply voltage. Levels between these limits are undefined.

A logic probe must be capable of distinguishing between low, high and undefined logic levels. There is also the possibility that an open-circuit may be encountered when using a logic tester. This could be due to the test probe not making good contact; or due to a circuit fault. Also, sometimes pins are intentionally not connected to anything (known as NC or No Connection in manufacturers' data). A logic tester must be capable of distinguishing an open-circuit from any of the other logic levels.

The circuit of the logic tester is shown in figure 1. Three voltage comparators are used to detect the four possible input conditions. The 'ref +', (reference) and '0' terminals of the tester are connected to the supply lines of the logic circuit under test. With a 5 V supply and S1 set to the 'TTL' position, 2 V will be present at the inverting input of IC1 and 0.8 V at the inverting input of IC2. With S1 set to the CMOS position the reference voltages will be respectively 60% and 40% of the supply voltage of the circuit being tested.

The inverting input of IC3 receives a potential of about -50 mV via R9, R7 and R6 from the negative rail of the tester's own ( $\pm 15$  V) supply. When the 'test' input is open-circuit, the non-inverting inputs of the three comparators will be pulled down to about -100 mV via R8. The outputs of all three comparators will be negative, so LED D1

will be lit. If the test input is connected to a voltage between zero volts and the logic 0 level the output of comparator IC3 will swing positive and D2 will light due to current flowing through it from the output of IC3 into the output of IC2, thus indicating 'logic 0'.

For voltages between the logic 0 and logic 1 levels the output of IC2 will also swing positive. D2 will extinguish and D3 will light due to current flowing through it from the output of IC2 to the output of IC1. This LED indicates the undefined logic state 'X'. When the logic 1 threshold is exceeded the output of IC1 will swing positive. D3 will extinguish and D4 will light, thus indicating 'logic 1'.

### Pulse indication

So far the discussion has been confined to the indication of static logic levels. However, pulses and pulse trains are frequently encountered in logic circuits. Pulse trains with a duty-cycle near 50% will cause both D2 and D4 to glow with reduced brightness. However, if the duty-cycle of a pulse train is very large or very small it will appear that one LED is lit continuously.

Also, short single pulses will be missed completely. To overcome this problem a 'pulse stretcher' circuit may be used, see figure 2.

The pulse stretcher is a one-shot multivibrator with an output pulse period of approximately 200 ms. When any pulse appears at the point in figure 1 labeled 'pulse', which is connected to the input of the pulse stretcher, the one-shot will be triggered and the LED will glow for about 200 ms. This is sufficiently long for the indication to be seen. If the pulse rate is greater than 5 Hz, D10 will appear to glow continuously.

A TTL-compatible pulse output is provided (A) for simple frequency counters etc. If this is not required, C2 and D5 can be omitted and R14 and R15 are replaced by a single 1 k resistor.

Figure 1. Basic circuit of the logic tester, which can detect high, low and undefined logic levels, and open-circuits.

Figure 2. A 'pulse stretcher' monostable.

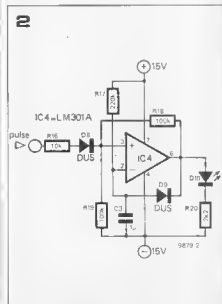
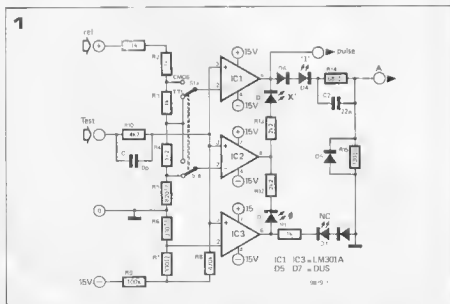

# market

## Pins

Track Pins, which enable soldered connections to be made to the two sides of PC boards, without the need for through-hole plating, now come in strip form. It's an amazingly simple idea from Harwin Engineers SA, that means much simpler, quicker and more cost-effective hand assembly.



Whatever the size of PC board, whether it's .033" or .040" diameter holes, Harwin Track Pins will make a connection that's both reliable and easy to inspect.

Harwin Engineers SA,  
Futsher Road, Farlington,  
Portsmouth, PO6 1RT, England.

(714 M)

## New microcomputer

The first generation of single-chip microcomputers experienced wide applications in low cost dedicated controllers. Designers experienced a need to replace mechanical and/or electrical functions with a single module which could be programmed for the desired function. These first microcomputers were distinguished by very limited instruction sets, small address space, small data words and slow speed. As the level of sophistication of applications increased, it became apparent that these devices were not adequate; hence a second generation of microcomputers was necessary to

fill the new and expanded needs. This brought forth a new wave of general purpose microcomputers with expanded instruction sets, larger addressing capabilities, larger data words and much increased speed. These microcomputers tended to be multi-chip systems for applications ranging from one board systems to complex multiprocessing systems which look like small main frame computers.

From these general purpose microcomputers came the second generation of single-chip micros. However, some of the features of the general purpose devices were lost. Instruction sets were reduced or modified and address space reduced or completely lost. The stage has again been set for a new single-chip microprocessor which can simplify existing hardware and software, yet provide expandability toward new horizons.

MOTOROLA's MC6801 (see photo) single-chip microcomputer provides the following functions toward this end:

1. Expanded MC6800 instruction set.
2. Source and object code compatible with MC6800.
3. Single-chip, self-contained microcomputer.
4. Bus expandable to 65 K Memory and I/O space.
5. 2 K bytes of ROM.
6. 128 bytes of RAM (64 are retainable).
7. Three timer functions.
8. 31 parallel I/O lines.
9. On-chip clock oscillator/generator.
10. Serial I/O.
11. Single 5 V power supply.

One of the most desirable functions for new products is to be as compatible with existing software and hardware as possible. The MC6801 implements the full MC6800 instruction set. The execution times of key instructions have been reduced to increase throughput. In addition, new instructions have been added. These include 16-bit operations and a hardware multiply. These features mean increased throughput and reduced software conversion and development time.

The bus expansion feature of the MC6801 allows the use of existing MC6800 family parts, with little or no extra hardware. This expansion mode permits the range from 256 to 65K locations. The MC6801 also contains three powerful 16-bit timer functions. One function is capable of generating a variable pulse width. A second function is capable of measuring a pulse width up to 16 bits of accuracy, and thirdly, a timer overflow status bit. Each of these functions can be used independently and concurrently. These functions may generate interrupts or be masked under software control.

The MC6801 as a single-chip microcomputer provides the user with thirty-one I/O lines configured as three 8-bit ports, one 5-bit port and two I/O control lines. The strobe lines may be used for peripheral handshaking or to interconnect with another microcomputer. The serial I/O port provides serial/parallel conversion for 8-bit start-stop data.



In conclusion, MOTOROLA's MC6801 is presented as a microcomputer for two different application needs. One is a powerful single-chip microcomputer with an expanded instruction set, powerful I/O, RAM, ROM, timer and serial I/O. The second is a microcomputer for multichip systems with full address and data buses.

Motorola Inc.,  
Semiconductor Products Division,  
16, Chemin de la Voie-Creuse,  
P.O. Box 8, 1211 GENEVA 20,  
Switzerland.

(719 M)

## Slim-line cardioid microphone

Mura Corporation has unveiled the DX-20 V, an eye catching microphone with cardioid response in a slim-line appearance. Excellent characteristics coupled with a truly esthetic design best describe this new microphone. Due to its uni-directional cardioid pattern, pickup from extraneous noise and acoustic feedback is dramatically minimized. The DX-20 V, having dual impedance capabilities, can be used as either



a 600 ohm or 50,000 ohm transducer, depending upon the particular application requirements. With high or low impedance sensitivities of -56 dB or -74 dB and a frequency response of 60-15,000 Hz, the new Mura microphone comes with a shielded 20 foot cable, a standard 1/4" phone plug and an on-off mike switch. Also included is a microphone holder and styrofoam case with sleeve.

Mura Corporation,  
177 Cantigue Rock Road,  
Westbury, NY 11590 USA.

(723 M)

## Eurocard Housings

Vero Electronics have extended their range of KM4 Case/Frames to include 1/2-width and 3/4-width versions. These cases are designed to form a self-contained housing for Eurocards and modules from the Vero KM4 System, and are manufactured from anodized aluminium extrusions and black PVC-clad cover panels. Clip-in guides may be positioned in the Case/Frame on multiples of 1F (5.08 mm) pitch, to allow many different combinations of contents.

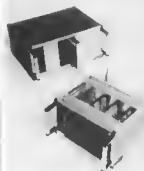

The new Case/Frame accept a front panel height of 3U (132.5 mm), and are available with an aperture width of 42E (213.4 mm) or 60E (304.8 mm). A full range of accessories, including circuit boards, connectors, modules, and hinged panels, is listed in the complete Vero Electronics catalogue.

Vero Electronics Limited,  
Industrial Estate, Chandler's Ford,  
Eastleigh, Hampshire, England.

(724 M)

# market

## Total development system

For the first time design engineers can now be provided with the Total Development System, from MOTOROLA, a self-contained unit containing all essential facilities for developing a complete hardware/software design.

The system is called the M68 TDS. Based on the M6800 micro-processor, the Total Development System includes the processor, a full ASCII keyboard, a 12.5 cm CRT display with up to 16 lines of 64 characters, and an audio-cassette for mass storage, all assembled in a table-top unit with its own power supplies. A medium speed printer can be supplied as an option.

There is a choice of either 8k byte or 16k byte of RAM with resident Editor/Assembler for developing M6800 source code programs. Alternatively, the two sizes of random access memory are available with a combination of Editor/Assembler and Basic Interpreter, allowing the TDS to be used with this popular high-level language.



Debugging is made easier by the efficient MINIBUG 3E firmware which enables the user to insert up to eight software breakpoints, and to carry out the TRACE function, in addition to the standard LOAD, PUNCH, MEMORY, CHANGE, GO TO and CONTINUE functions. Two spare slots are available on the M68 TDS, both compatible with Motorola co-processor/micromodules, for the user to add options like input/output

interfaces, more memory, or even a 2708 PROM programmer.

*Motorola INC.,  
Semiconductor Products Division,  
P.O. Box 8, 16 Chemin de la  
Voie-Creuse, 1211 Geneva 20,  
Switzerland.*

(1725 M)

## Ionization-type smoke alarm

The availability of the new On-Guard Smoke Alarm has been announced by the International Division of the On-Guard Corporation of America. This new Model SM870 Smoke Alarm operates on the ionization principle to give early warning and more time to escape before dangerous fire conditions develop. The sensing chamber detects invisible products of combustion before visible smoke, heat and flames. As soon as the tiny combustion particles are detected, a loud alarm sounds — a loud 85 dB sound that is annoying enough to awaken people sleeping soundly behind closed doors. The On-Guard Smoke Alarm is operated by one inexpensive 9 volt battery and is constantly monitored by a battery level circuit. When the battery has reached the end of its useful life, the alarm gives an intermittent signal every 30 seconds for a minimum of 7 days. A test button is provided to check the entire alarm circuitry, including calibrated sensitivity, horn and battery.

The solid state circuitry designed and built into the SM870 Smoke Alarm assures reliability, stability and long-life. This new early-warning device is also attractively styled with an impact resistant off-white case that blends with any decor. It is easily installed — all that's needed is a screwdriver.

For minimum life-safety protection, one On-Guard alarm should be located in the hallway near each sleeping area. For more

complete protection, an alarm should be installed on every level of a home and inside smoker's room.

*On-Guard Corporation of  
America, International Division,  
2200 Shames Drive, Westbury,  
N.Y. 11590, USA.*

(1726 M)

## Compact display

Flexibility, convenience and low cost characterize this new CRT display module from Hewlett-Packard. Designed to be easily integrated into instrument or systems consoles, this Model 1340 A Display Module is designed with the OEM user in mind. A new modular approach to electrical and mechanical design gives the user the option to locate functional controls wherever they are most convenient, or to use other controls. Because the 1340A can be purchased without controls and without a power supply, the user also has the option to use other dc power sources.

The compact display requires only sufficient panel space to accommodate the CRT face. With a 114 cm<sup>2</sup> (9.5 x 12 cm) viewing area, the display (plus bezel) occupies only 128 x 163 x 438 mm of panel space. Integrated circuits contain most of the X and Y amplifier components as well as Z-axis circuitry, thus improving reliability while reducing cost. X and Y attenuators, input impedance and bandwidth limits can be selected by internal switches. These features not only offer flexibility in system design, but reduce inventory problems when the Model 1340A is used in more than one instrument or system.



Resolution, viewing area and brightness are suitable for applications such as spectrum, network and vibration analysis. Spot size is less than 0.46 mm at center screen. Line resolution at center screen is about 25 lines/cm. The CRT can be rite directly from analog circuits or from digital memory on a refreshed basis. A dc gain adjustment lets the user remotely program changes in the parameters being displayed. Other applications include airborne systems in which the display can be powered directly from the aircraft system, in

communication system analysis and in production test systems. A number of OEM cabinet options are available. With the Model 1340A mounted in a full rack cabinet, the user has space to include other test system circuitry.

*Hewlett-Packard Ltd.,  
Kingstreet Lane,  
Winnersh, Wokingham, Berkshire,  
England*

(1721 M)

## BiMOS opamp

RCA Solid State has introduced dual versions of the CA 3140 Series of BiMOS integrated-circuit operational amplifiers. Designated CA 3240A and CA 3240 the operational amplifiers combine the advantages of MOS and bipolar transistors on the same monolithic chip, with p-MOS field-effect input transistors and bipolar output devices.

The gate-protected p-MOS input transistors of the CA 3240 Series provide a high input impedance (typically 1.5 T $\Omega$ ) and a wide common-mode input voltage range (typically to 0.5 V below the negative supply rail), while the bipolar output transistors allow a wide output voltage swing and provide a high output current capability.

The rugged input stage is protected by bipolar diodes, and the input current is typically only 10 pA at  $\pm 15$  V. Applications for the CA 3240 Series include ground-referenced single-supply amplifiers in automobile and portable instrumentation, sample-and-hold amplifiers, long-duration timers and multivibrators, photocurrent instrumentation, active filters, intruder alarm systems, comparators, instrumentation amplifiers, function generators and power supplies.

The CA 3240 Series can be used as a direct replacement for industry types 747 and 1458 operational amplifiers in most applications, and will operate from 4 V to 36 V single or dual supplies. The operational amplifiers are characterized for  $\pm 15$  V operation and for TTL supply systems with operation down to 4 V.

Operating bandwidth is very wide: 4.5 MHz unity gain at  $\pm 15$  V or 30 V, and the devices feature a high voltage-follower slew rate of 9 V/ $\mu$ s.

The amplifiers are supplied in the 8-lead dual-in-line Mini-DIP package or the 14-lead dual-in-line plastic package. Operating temperature range is 40°C to +85°C.

*RCA Solid State,  
Sunnyvale-on-Thames, Middlesex,  
TW16 7HW, England*

(1764 M)



**At Newark From Remaining Inventory.**  
 Fresh from inventory may have 1000's of units & units on order (SOQ)  
 Many open from the following 1.88 or 8.88 per unit. Early delivery 1 month  
 in some quantities for less than 1.00 per unit.  
 Bulk lots of 1000's and 5000's. Bulk order discounts from stock.  
 Most 2000's or 1000's units for major projects complete within  
 four weeks. All units shipped by air freight.  
 3. Delivery on order of 100 units available for all our products.



## EXPERIMENTING WITH SC MP

**BUILD YOUR OWN MICROPROCESSOR DEVELOPMENT SYSTEM**

The reason that we have made this announcement is a feature that does not exist anywhere else in a single integrated circuit development kit. In addition, a personal computer system with a built-in display unit, contains basic programs with an extensive memory capacity.  
 This kit lets you get maximum benefits and use programming kit for the 7801 for half price of the other kits. You can order just these parts you need and we will duplicate your program on a floppy disk.

Call for more information. **7801** or **7802** or **7803** or **7804** or **7805** or **7806** or **7807**



## CATALOGUE 78

Call for more information. In Canada orders of more than one unit for special pricing. We can also supply a complete kit of parts and materials for the kit. All orders are shipped by air freight. Delivery on order of 100 units available for all our products.

50%

## INDEX & EQUIPMENT

Part Number	Description	Price
7801	Microprocessor Development System	\$199.95
7802	Microprocessor Development System	\$199.95
7803	Microprocessor Development System	\$199.95
7804	Microprocessor Development System	\$199.95
7805	Microprocessor Development System	\$199.95
7806	Microprocessor Development System	\$199.95
7807	Microprocessor Development System	\$199.95

## OPTOELECTRONICS

Part Number	Description	Price
7901	Optoelectronic Component	\$1.99
7902	Optoelectronic Component	\$1.99
7903	Optoelectronic Component	\$1.99
7904	Optoelectronic Component	\$1.99
7905	Optoelectronic Component	\$1.99
7906	Optoelectronic Component	\$1.99
7907	Optoelectronic Component	\$1.99
7908	Optoelectronic Component	\$1.99
7909	Optoelectronic Component	\$1.99
7910	Optoelectronic Component	\$1.99

## CAPACITORS

Part Number	Description	Price
8001	Capacitor	\$0.10
8002	Capacitor	\$0.10
8003	Capacitor	\$0.10
8004	Capacitor	\$0.10
8005	Capacitor	\$0.10
8006	Capacitor	\$0.10
8007	Capacitor	\$0.10
8008	Capacitor	\$0.10
8009	Capacitor	\$0.10
8010	Capacitor	\$0.10

## 7801 FILTER AMPLIFIERS

Part Number	Description	Price
7801	Filter Amplifier	\$1.99
7802	Filter Amplifier	\$1.99
7803	Filter Amplifier	\$1.99
7804	Filter Amplifier	\$1.99
7805	Filter Amplifier	\$1.99
7806	Filter Amplifier	\$1.99
7807	Filter Amplifier	\$1.99
7808	Filter Amplifier	\$1.99
7809	Filter Amplifier	\$1.99
7810	Filter Amplifier	\$1.99

## TRANSISTORS & DIODES

At Newark From Remaining Inventory. Fresh from inventory may have 1000's of units & units on order (SOQ). Many open from the following 1.88 or 8.88 per unit. Early delivery 1 month in some quantities for less than 1.00 per unit. Bulk lots of 1000's and 5000's. Bulk order discounts from stock. Most 2000's or 1000's units for major projects complete within four weeks. All units shipped by air freight. Delivery on order of 100 units available for all our products.

## IC'S

Part Number	Description	Price
1001	IC	\$1.99
1002	IC	\$1.99
1003	IC	\$1.99
1004	IC	\$1.99
1005	IC	\$1.99
1006	IC	\$1.99
1007	IC	\$1.99
1008	IC	\$1.99
1009	IC	\$1.99
1010	IC	\$1.99

## LOW COST CARDS

Part Number	Description	Price
1101	Low Cost Card	\$1.99
1102	Low Cost Card	\$1.99
1103	Low Cost Card	\$1.99
1104	Low Cost Card	\$1.99
1105	Low Cost Card	\$1.99
1106	Low Cost Card	\$1.99
1107	Low Cost Card	\$1.99
1108	Low Cost Card	\$1.99
1109	Low Cost Card	\$1.99
1110	Low Cost Card	\$1.99