

**ES**  
November 1977  
45p/USA \$1.50  
**ELEKTOR**  
up-to-date electronics for lab and leisure

**video biofeedback**  
**get to grips with microprocessors by**  
**'experimenting with the SC/MP'**

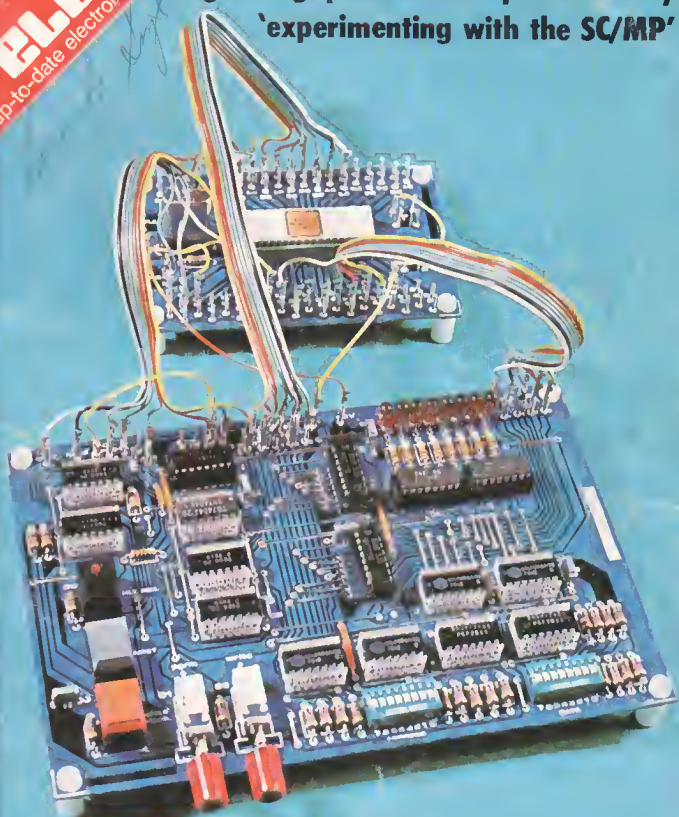



The electrometer will indicate the presence of an electric field, and fluctuations in its field strength. This may prove useful when investigating psychic phenomena . . .

The video biofeedback system consists of an alpha-wave detector and a visual display generator. The display consists of a white square on a TV screen; the size of this square increases as a higher level of alpha-activity is registered.

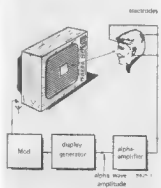

The practical construction of the racing cars for the slotless model car track is discussed in this (final) article in the series. A large number of electronic and electro-mechanical components must be mounted within the cramped confines of a model car . . .

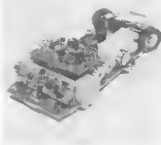

Experimenting with the SC/MP is a good way to get the feel of microprocessors. The first step is to build the (very basic) operational unit shown on this month's cover.

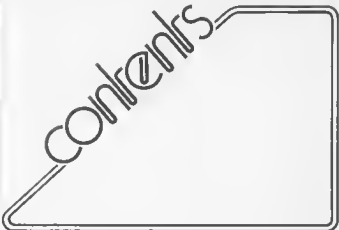

selektor . . . . .	E14
microprocessors - can you afford not to understand them? . . . . .	11-01
experimenting with the SC/MP (1) . . . . .	11-02
H. Huschitt By far the best way to gain a clear understanding of the complexities of microprocessors is through the practical experience of actually constructing and learning to operate one of these 'microcomputers'.	
fields . . . . .	11-13
electrometer . . . . .	11-14
ejektor . . . . .	11-17
relaxation generator	
ccir tv pattern generator (3) . . . . .	11-18
Having completed those sections of the circuit that produce the CCIR standard sync. signal, attention is now given to the design of the pattern generator module, which will turn the instrument into a versatile aid to TV adjustment and servicing.	
poltergeist . . . . .	11-22
The title of this article should really be 'remote-controlled poltergeist-imitator'. By operating a miniature ultrasonic transmitter concealed for example in one's jacket pocket, a receiver hidden somewhere in the room will simulate the sound of a poltergeist loose in the house.	
video biofeedback . . . . .	11-24
In recent years the use of biofeedback techniques to achieve conscious control of brain activity has become extremely popular. Of particular interest is 'alpha feedback' which, by stimulating the production of alpha-waves, promotes relaxation.	
magnetiser . . . . .	11-32
Recent medical experiments have lent weight to the idea that magnetic fields are of therapeutic value in the treatment of psychosomatic complaints and rheumatic ailments. The following article, which is preceded by details of a controlled experiment into the efficacy of this method of treatment, describes a device which will produce an alternating magnetic field of the type suitable for medical use.	
slotless model car track (6) . . . . .	11-34
This final article in the series on the slotless car track discusses the remaining electronic circuits, namely the power supplies for the car, track and infra-red transmitter, before describing the mechanical construction of the car and testing of the complete system.	
formant - the Elektor music synthesiser (5) . . . . .	11-41
C. Chapman Last month's article dealt with the theoretical circuits used in the VCO. This month's contribution covers the selection of components for, and the practical construction of, the VCO module, after which testing and adjustment of the VCO are described.	
market . . . . .	E15
advertisers index . . . . .	E26

# experimenting with the SC/MP

Before commencing, it is perhaps worth reviewing what is 'on the programme' for the next few articles in this series. The flowchart in figure 1 should help the reader to decide if he wants to pursue the topic further. The series calls a temporary halt after part 4 of the series, by which time the budding programmer should possess a microprocessor incorporating a cassette-interface and hexadecimal in- and outputs (using seven-segment displays). For the future, a TV-interface and keyboard are planned, which will convert the development system into a full-grown microcomputer.

## SC/MP

SC/MP (pronounced 'scamp') denotes a National Semiconductor microprocessor, type ISP-8A/500D, and stands for Simple Cost-effective Microprocessor. The SC/MP is a modern, low-cost microprocessor. Its design structure or 'architecture' makes it ideally suited to simple applications. Simple two-chip systems (CPU + PROM) can be realised directly using the SC/MP, and assuming that high operating speeds are of secondary importance, the SC/MP can also be used to construct relatively complex systems. There are two versions of the SC/MP available at present. The first and older version (type number ISP-8A/500D) uses P-channel-MOS technology, whilst the more recent SC/MP II (ISP-8A/600D) is an N-MOS version. The two versions are fully compatible, the only difference being that the later version has a higher speed capability, lower power dissipation and requires only one supply voltage.

The SC/MP has 40 pins, of which a number are TTL-compatible. The data- and address buses have tri-state outputs. For most applications, a detailed knowledge of the internal architecture of the IC is not required, and it can be looked upon simply as a 'black box'. The following features however should be noted: the SC/MP has an internal clock generator; this requires only one external component, which can be either a quartz crystal ( $f_0 = 1 \text{ MHz}$  or lower) or a capacitor ( $C = 500 \text{ pF}$  or greater). Since the SC/MP is a static micro-

processor, the clock frequency can be lowered as much as desired so that the individual programme steps can be easily distinguished. Two pulses of the clock oscillator are required for each so-called 'microcycle'. In the case of a 1 MHz crystal each microcycle takes  $2 \times 1 \mu\text{s} = 2 \mu\text{s}$ . Depending upon the instruction which it must execute, the basic machine cycle (the combined fetch and execution of a single instruction) requires between 5 and 22 microcycles.

H. Huschitt

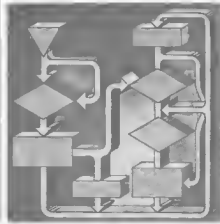

processor, the clock frequency can be lowered as much as desired so that the individual programme steps can be easily distinguished.

Two pulses of the clock oscillator are required for each so-called 'microcycle'. In the case of a 1 MHz crystal each microcycle takes  $2 \times 1 \mu\text{s} = 2 \mu\text{s}$ . Depending upon the instruction which it must execute, the basic machine cycle (the combined fetch and execution of a single instruction) requires between 5 and 22 microcycles.

## SC/MP registers

The SC/MP has 7 registers which are accessible to the user (programmer), as shown in figure 2.

- *Programme counter (PC, identical to the pointer register  $\Phi$ )*

The programme counter is a 16-bit register which contains the address of the next programme instruction to be executed by the microprocessor. In order to ensure that all registers in the microprocessor are cleared to zero when the supply is switched on, the NRST (negative reset input) pin must first be set to logic state '0', thereby resetting all the registers. The first '1' or high state will then cause the SC/MP to start up. The first instruction is found under the address  $\Phi\Phi\Phi 1$  (i.e. not  $\Phi\Phi\Phi 0$ ). In programmes with a  $\Phi\Phi\Phi 0$  start address the first instruction must either be a non-memory reference instruction or a NOP instruction (No Operation). Note  $\Phi = \text{Zero}$ ,  $0 = \text{letter o}$ .

In order to fetch an instruction from memory, the address, i.e. the content of the PC is put on the address bus. During the NRDS (negative read data strobe) the content of the addressed memory location is put on the data bus, and this instruction byte (byte = 8-bit word) is then delivered to the instruction register and decoded by the instruction decoder. If the MSB (Most Significant Bit) is a '1', then the  $\mu\text{P}$  knows that the instruction actually consists of two bytes, in which case, after incrementing the PC, the processor performs a second fetch to obtain the full instruction.

It is worth noting that the PC is always incremented before the instruction is

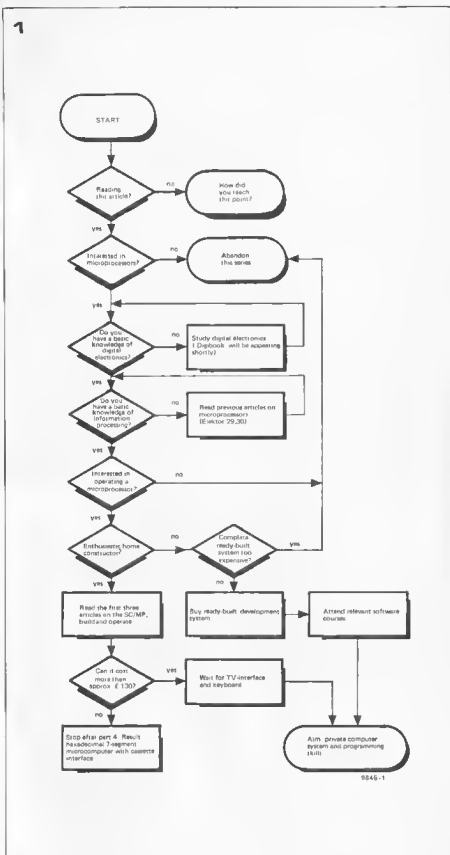

executed, the only exception to this rule is in the case of jump instructions, when the instruction is executed before the PC is incremented. The actual execution of an instruction requiring arithmetical or logical operations is carried out by the ALU. The whole cycle is then repeated with the next instruction, which is contained in the numerically adjacent address to the first.

Figure 1. This figure gives an idea of what is 'on the programme' for the SC/MP series.

### • Pointer registers (PTR)

In addition to the programme counter the SC/MP contains three other pointer registers PTR1, PTR2 and PTR3. These are also 16-bit registers used primarily to store addresses. The content of the PC can be exchanged with that of a pointer register so that the programme jumps to the address previously stored in the pointer. The jump back to the main programme will only occur after a second jump instruction (XPPC = Exchange Pointer with Programme Counter). The main programme then picks up where it left off, i.e. at the address which it temporarily stored in the pointer register.

A simple example may help to clarify this manoeuvre. Imagine that Tom (= PC) is hungry and is taking regular bites out of an apple. Dick (= PTR) has had enough, but he's holding a half-eaten pear. At a certain point they are told to swap (XPPC). Tom now has the pear, which he proceeds to demolish with the same regularity originally reserved for the apple. After a second XPPC command Tom find himself again holding the apple and, since Dick wasn't hungry, Tom can continue at exactly the same point that he had reached before the first exchange.

Pointer registers are extremely useful when executing such chores as compiling and reading or storing tables.

### • Accumulator

The accumulator is an 8-bit register by means of which all manipulation of data is carried out. Only data which are present in the accumulator can be processed by the ALU, and conversely data may only be read into memory via the accumulator. When new data are entered into the accumulator, the data previously held there are lost.

### • Extension Register (E)

The extension register, which is also an 8-bit register, serves, as its name suggests, as an extension of the accumulator. If information present in the accumulator needs to be retained, then it can be stored in the extension register. In addition, the extension register can be used as a parallel-series or series-parallel converter. To this end it has a series input (SIN, pin 24) and a series output which is buffered by a flip-flop (SOUT, pin 23). An SIO instruction (Serial In/Out) shifts the content of E one bit to the right. The information present at SIN then becomes the highest bit in the extension register and the lowest bit is simultaneously shifted into the buffer flip-flop.

### • Status Register (SR)

This 8-bit register performs numerous useful functions which will be examined later in the article.

### Hexadecimal notation

The only language that a computer understands is its particular 'machine language' or combination of 'noughts' and 'ones'. For example the instruction

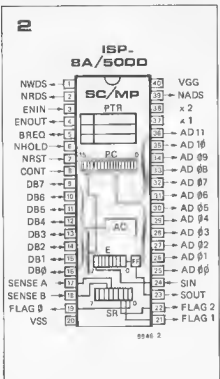

Figure 2. The pin configuration of the SC/MP.

Figure 3. Diagrammatic representation of a two-byte instruction.

Figure 4. Block diagram of the basic version of the SC/MP development system.

Figure 5. The circuit of the RAM I/D-card.

Table 1. Hexadecimal notation uses letters as well as numbers.

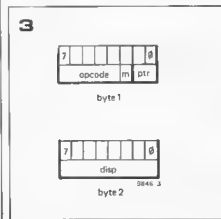
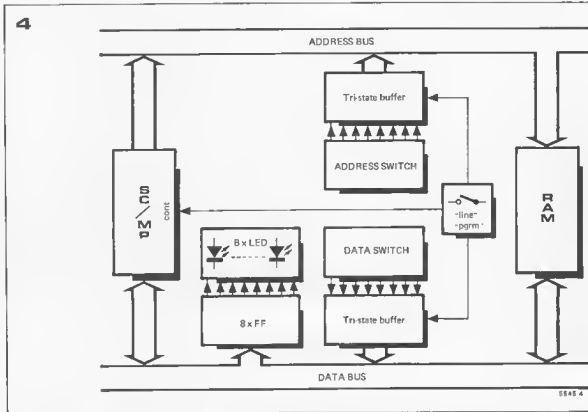

Table 1

decimal	hexadecimal
0	0
1	1
2	2
3	3
4	4
5	5
6	6
7	7
8	8
9	9
10	A
11	B
12	C
13	D
14	E
15	F
16	10
17	11
18	12
19	13
20	14
21	15
22	16
23	17
24	18
etc.	etc.



1100011100000001 is recognised by the SC/MP as signifying: load the accumulator with the content of the memory location whose address is in pointer register 3, then increment the content of this pointer by 1. It is apparent that when the programmer comes to write out or assemble his programme both the machine language and the longhand translation prove excessively unwieldy. For this reason either so-called assembler language or hexadecimal notation are used. The above instruction may thus be written either as C701 or LD@1 (3).

The latter is the mnemonic abbreviation or assembler language, used in the SC/MP software, whilst the former is simply the hexadecimal version of the binary code. The assembler language consists of a group of mnemonic letters and symbols (not binary numbers). It can be processed by an assembler programme in the computer, the result being the machine language programme which can then be run in the computer. The derivation of hexadecimal from binary code was discussed in a previous article (Elektor 30, October 1977), however since working with micro-

processors demands a certain proficiency in 'thinking' and being able to calculate in hexadecimal code, the following examples should help to familiarise the prospective programmer with this number system.

$$\text{Addition: } \begin{array}{r} 0C \\ 0C \\ \hline 18 \end{array} +$$

Explanation: twelve (C) plus twelve (C) equals twenty-four, which equals one times sixteen plus one times eight (see table 1).



6

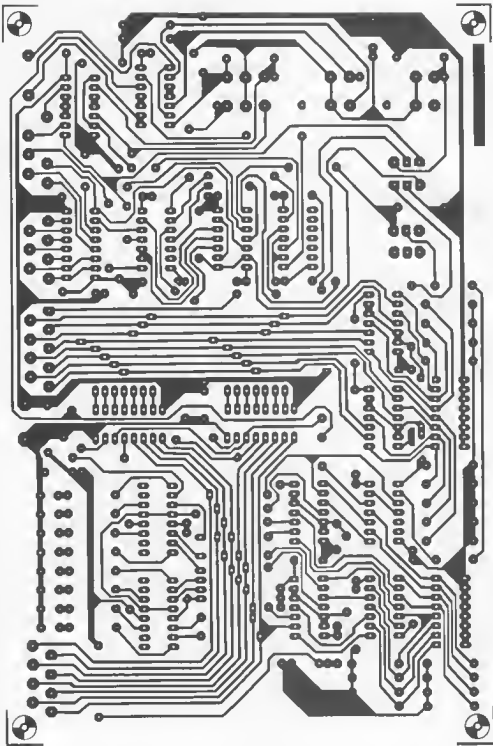

## Parts list to figures 5 and 7

## Resistors:

R3, R30 = 220  $\Omega$   
 R4 ... R11, R31 = 330  $\Omega$   
 R12 ... R35 = 4k7  
 (no R1, R2)

## Capacitors:

C1 ... C7 = 10 n

## Semiconductors:

IC1 = 74155  
 IC2, IC8, IC9 = 7404  
 IC3, IC14, IC16 = 7400  
 IC4, IC5 = 7475  
 IC6, IC7 = MM2112 (National)  
 IC10 ... IC13 = CD4066  
 IC16 = 7474  
 D1 ... D9 = LED (D9 in S5)

## Miscellaneous:

S1 = DPDT  
 S2 = SPST, e.g. Schodow  
 'Digitast'  
 S3 = SPST  
 S4 = SPDT, e.g. 'Digitast'  
 S5 = SPDT, e.g. 'Digitast', with  
 LED  
 S6, S7 = 8-bit DIP-switch

The highest bit (bit 15) of the numbers designated as negative, is, as the above examples make clear, '1'. The microprocessor recognises this bit as indicating a negative number. In the case of an 8-bit word, capable of representing 256 numbers, the largest possible (positive) number will therefore be  $01111111 = 7F = 127$ . That means that, including zero, an 8-bit word may represent 128 positive numbers. The smallest (negative) number possible is, logically enough,  $128 - 256 = -128$ , which equals  $10000000 = 80$ .

## Instruction set

The number of possible instructions for the SC/MP is not particularly large, only 46. Although this in no way limits the range of possible applications, it places greater demands upon the amount of storage capacity required and inevitably renders the programme slightly more cumbersome. Thus for extremely large and complex processing chores it is recommended to invest in one of the more sophisticated and expensive types of microprocessor.

A complete description of all 46 instruc-

tions would occupy too much space, the reader is therefore referred to the SC/MP data sheet. Some instructions will be examined later in the article.

## Instruction format

The SC/MP recognises both one- and two-byte instructions (one byte is 8 bits). The SC/MP instruction guide lists 'operation codes' (opcodes) in hexadecimal form for each instruction. For some instructions it is necessary to indicate which pointer register is being referred to. This is done by

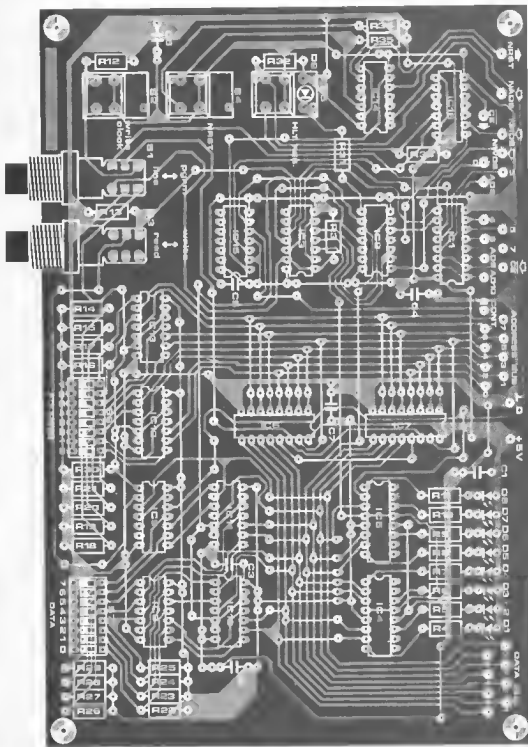

Figure 6. Printed circuit board layout for the RAM I/O-card (EPS 9846-1).

Figure 7. Component layout of the RAM p.c.b. This board also accommodates all the control switches.

adding the number of the pointer to the opcode. For example, XPPC 3 means 'exchange pointer 3 with PC'. The hexadecimal opcode basis for this instruction is 3C and the instruction refers to pointer 3, so in this case the instruction becomes 3C + 3 = 3F (= 00111111).

In the case of two-byte instructions, the opcode is followed by the 'displacement' (see figure 3). For all two-byte instructions this displacement is a number between -128 and +127. The only exception to this rule is the delay

instruction (DLY), when the displacement is between 0 and 255. Basically, the displacement gives additional data required for a particular instruction. For instance, if the first byte specifies 'delay', the second byte will specify the duration required; or, if the first byte is a 'load' instruction, the second byte either gives the data or the location where the data are to be found.

#### Address modes

When data are to be stored in or read out of a specific memory location, it is



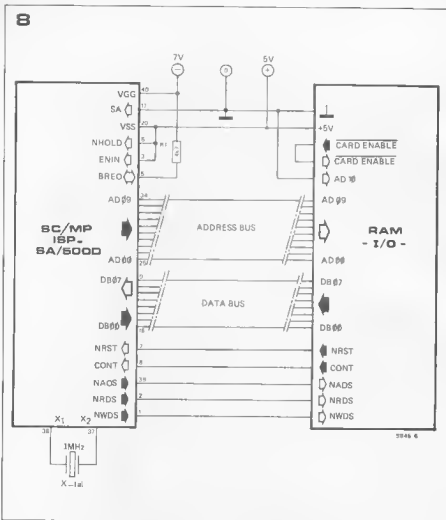

Figure 8. This diagram shows the various connections between the SC/MP and the RAM-card.

Figure 9. The SC/MP printed circuit board (EPS 9846-2).

Figure 10. The component layout of the SC/MP p.c.b.

#### Parts list to figures 8 and 10.

##### Resistors:

R1 = 4k7

##### Semiconductors:

IC = ISP-SA/5000 (SC/MP)

##### Miscellaneous:

1 MHz crystal

clear that the total instruction must contain the address of the location which is being referenced as well as the Read or Write command. Two bytes would be needed to be able to address every memory location of a 64 k memory (= 65,536 locations). Furthermore, one byte is required for the operation code, so that a total of three bytes would be required for the complete instruction.

Several types of microprocessor do in fact use this instruction format. However, the SC/MP adopts a different method requiring only two-byte instructions. This is achieved by using the following address modes:

#### • PC-relative addressing

The content of the PC is used to reference the required address (= effective address = EA). The effective address is obtained by adding the 'displacement' to the content of the PC:  $EA = (PC) + (disp.)$ . ((PC) signifies 'the content of PC'). Using this method memory locations both 'above' and 'below' the content of the PC can be addressed, since the displacement may be either positive or negative. The highest effective address is logically  $(PC) + 127$ , and the lowest  $(PC) - 128$ . It is clear that this method does not permit every address of the 64 k memory to be referenced. To achieve this it is necessary to use 'PTR-relative' or 'indexed addressing'.

#### • Indexed addressing

A 2-byte address is loaded into one of the pointers and the effective address is obtained by adding the displacement to the content of the pointer:  $EA = (PTR) + (disp.)$ . Using this address mode it is possible to reference every location in the 64 k memory, since the pointer may be loaded with any address. Bits 0 and 1 of the instruction byte are used to inform the microprocessor of the number of the pointer in question (see figure 3).

#### • Auto-indexed addressing

This address method is virtually the same as indexed addressing, the only difference being that the content of the pointer is automatically incremented by the value of the displacement.

When the displacement is negative, the pointer content is first altered and then the instruction is executed; when the displacement is positive the instruction is first executed and then the pointer is modified:

neg. disp.:  $EA = (PTR) + (disp.)$

pos. disp.:  $EA = (PTR)$

In this address mode bit 2 of the first instruction-byte, the 'modify-bit', is always '1'. This is indicated in the assembler language by the symbol @, which signifies the use of auto-indexed addressing.

In the case of both indexed and auto-indexed addressing, the four highest bits

of the pointer remain unchanged since the displacement is a number between -128 and +127.

With regard to these first three address modes it should be noted that when the displacement is -128 (X'80), it is no longer used to obtain the effective address. In this case it is replaced by the content of the extension register:  $disp. = -128 + EA = (PTR \text{ or } PC) + (E)$ .

#### • Immediate addressing

This fourth address mode is not really a method of addressing at all! No address is referenced, the microprocessor simply interprets the second instruction-byte as the required data. For example, the instruction  $LDI \ X'35$  (LDI = Load Immediate) will result in the microprocessor loading the accumulator with X'35 without this number having to be stored somewhere in memory (National Semiconductor use the symbol X' to indicate that what follows is a hexadecimal number).

#### RAM I/O-card

Having hopefully digested the above theory, it is time to get down to practice. The main requirement is a PROM or RAM in which to store the programme for the SC/MP. In order to programme a PROM a special piece of equipment is required, which unfortunately is rather expensive.

A cheaper solution is to use a RAM in conjunction with 'peripheral' hardware

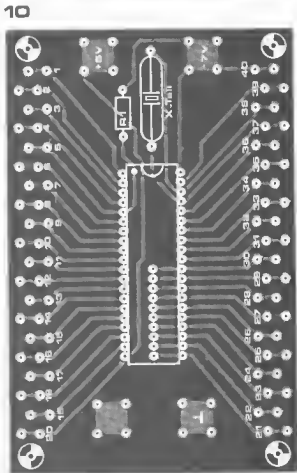
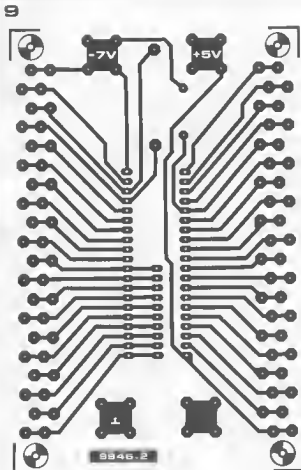

which will allow a programme to be written in. This is illustrated in the block diagram in figure 4. Both the CPU and the RAM are connected to the address and data buses. Two 8-bit DIP switches are also connected to the data and address buses via tri-state buffer-ICs. These switches form the peripheral hardware which will enable the programme to be written in. When switch S is in the 'pgrm' position, a programme can be loaded into the RAM. The position of the address switch determines in which location the data read in by the data switch will be stored. In this way any desired programme may be written into the RAM. Since an 8-bit switch is used for the addresses, the available storage capacity of the RAM is limited to a 256 x 8 memory.

When switch S is in the 'line' position, the microprocessor will begin to operate and execute the programme stored in the RAM. A visual display is provided in the form of 8 LEDs. During programming, these LEDs will indicate the information present on the data bus. When the programme is running, the LEDs can also be used to display data, providing that they are 'addressed'.

### The circuit

Figure 5 shows the complete 'hardware' for the SC/MP memory and peripherals. The 256 x 8 bit RAM is formed by two MM2112 ICs (IC6, IC7). Addresses are

gated via buffers IC12 and IC13 onto the parallel-connected address inputs by means of switch S6. Since tri-state buffers are still fairly expensive, 'normal' analogue switches, type CD 4066, are used instead. In the same way, data are gated onto the data bus lines via data switch S7; these data are displayed visually by means of LEDs D1...D8. Since these LEDs are driven by TTL-ICs (IC4, IC5), the inputs of the integrated analogue switches (IC10, IC11) must also be driven by TTL-outputs, hence the need for the inverters N9...N16.

The address-bits AD08...AD10 are connected to IC1 which functions as an address decoder. These bits determine which part of the system is addressed. For the time being, of the 8 available outputs only 3 are used, namely the 0, 1 and 2 outputs which address the RAM, the LEDs and the data switch (DS) respectively (see table 2). The remaining decoder outputs can be implemented at a later stage to address additional memory or peripherals. The system is controlled by means of five switches:

- **S1a-S1b, the line-programme switch**  
In the 'line' position the SC/MP assumes command of the data- and address buses, whilst S6 and S7 are disabled; in the 'pgrm' position a programme may be loaded into the RAM, by means of S6 and S7.

- **S2, clock-write switch**

By operating this switch, the information represented by the position of S7 is written into the RAM; S2 will only function with S1 in the 'pgrm' position.

- **S3, read-write switch**

The content of the RAM can be checked by setting S3 in the 'read' position. The LEDs display the content of the memory location addressed by S6. S3 will only function if S1 is switched to 'pgrm'.

- **S4, NRST switch**

As soon as S4 is operated, all SC/MP registers are cleared. Once the start signal is given, the SC/MP begins to execute the programme, starting with the instruction in location 0001. The start command is given by switch S5.

- **S5, halt-reset switch**

Many programmes contain 'halt' instructions. In the case of such an instruction the SC/MP resets 'halt' flip-flop FF1, so that the CONT-input of the SC/MP is pulled low and the programme is halted. This condition is indicated by LED D9. Operating S5 sets FF1, so that the SC/MP recommences execution of the programme.

The circuit shown in figure 5 contains a large number of in- and outputs. Most of these must be connected direct to

11

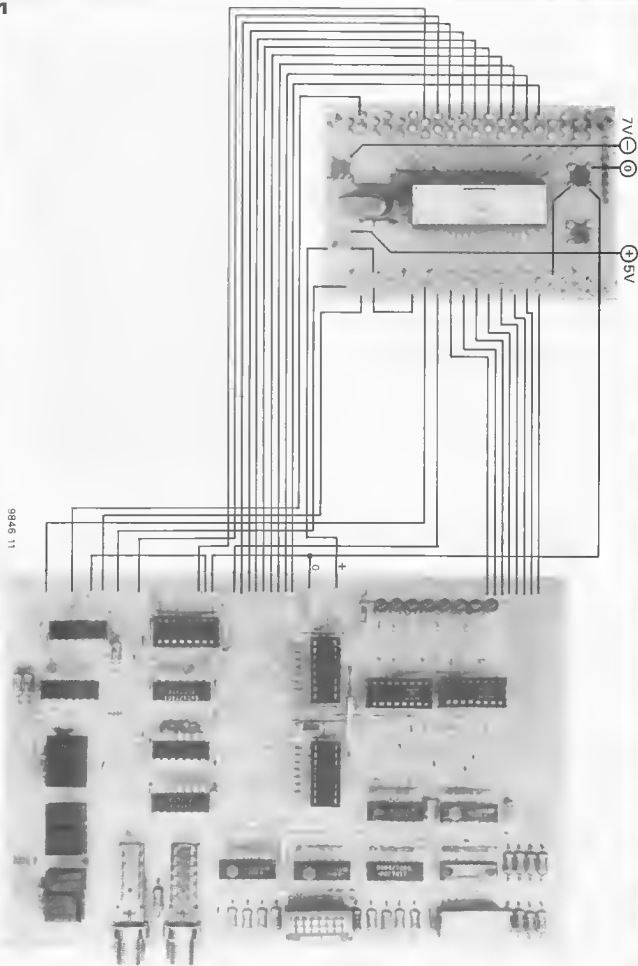

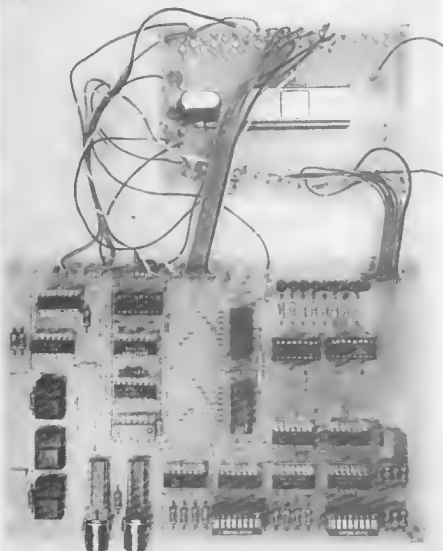

Figure 11. The wiring plan for the two circuit boards. All solder connections should be complete before mounting the MOS-ICs (that includes the SC/MP).

Figure 12. The complete 'hardwired' version of the system, ready to execute its first programme.

the SC/MP; the details of the various connections are shown in figure 8. Note that address-bit 10 of the RAM I/O-card is at logic '0'. Since this input is formed by the parallel connection of two TTL-inputs (pins 1 and 15 of IC1), it cannot be driven directly by the SC/MP. Fortunately, however, this does not present a problem, since only three peripheral addresses are required at present (see table 2).

For the time being, the card-enable input and output are simply interconnected. At a later stage the input can be used to disable the RAM-card, and this can prove extremely useful in the case of larger systems.

### Construction

Two printed circuit boards were designed to accommodate the complete system. The circuit shown in figure 5, including the various switches, is mounted on the first board (see figures 6 and 7). The second board (see figures 9 and 10) takes the SC/MP, the quartz crystal and a resistor (R1). Since this board later becomes superfluous, it has

a fairly general purpose' layout, thus enabling it to be reused for other applications. This does tend to complicate the wiring slightly, but if the wiring diagram in figure 11 is followed exactly there should be no problems.

The use of plug-in connectors is recommended, as this means that the 'hardware' can also be easily altered. How the completed version looks can be seen from figure 12 (and this month's cover picture).

### Supply

As is apparent from the circuit diagram, two supply voltages, +5 V and -7 V, are necessary. The +5 V supply must be capable of delivering a current of at least 0.5 A, and the -7 V supply a current of approx. 100 mA. Both supplies should of course be stabilised. In both cases an IC-stabiliser is the best solution.

In view of future extensions to the circuit it is advisable to use a +5 V supply that can deliver a current of 1.5 A.

### The first programmes

A prerequisite for operating the SC/MP is the SC/MP data sheet (Pub.-Nr. 420305227-001 A). When compiling a programme the above-mentioned 'SC/MP Instruction Guide' is also virtually indispensable. The programme examples assume that the user already has both these publications.

Table 2 shows a simple add programme arranged in the conventional programme form. The first column contains the address of the first instruction-byte of each instruction. NOP (no operation) is a 1-byte instruction, and the following byte therefore belongs to the next instruction. The second instruction is a 2-byte instruction, so that the first byte is stored at 0001, the second byte at 0002.

The second column contains the instructions and the operand addresses in (hexadecimal) machine code. The first two columns represent the results of the assembler programme. As mentioned earlier, an assembler programme can be used to translate a programme written in assembly language (the mnemonic letters and symbols in column 3) into the necessary logic (ones and zeros) that make up the machine code.

Column three contains the instructions and address symbols written in assembly language. Address symbols consist of a maximum of 6 randomly chosen letters or digits (without punctuation signs; the first symbol is always a letter). The assembler 'reads' the address symbols and calculates the required displacement values.

The last column contains an explanation of the programme steps; it has no effect upon the assembler.

As is apparent from table 2, when addressing the RAM, the LEDs or the data switch (DS), only the two highest address bits are decoded. This naturally

has certain consequences for the programming. For example, the LEDs will be referenced by every address beginning with 01. In the programme, PTR1 is used to address the LEDs, and PTR2 for the DS (only the 'higher' byte of the registers is used). In order to load the pointers, the information is first loaded into the AC, and the content of the AC is exchanged with that of the 'higher' pointer byte. The instruction ADD0(2) causes the information represented by the position of the data switch to be added to the content of the AC (= 00); the result of this operation is stored in the AC. The next instruction results in the content of the AC being displayed by the LEDs. There then follows a HALT-instruction and the programme is interrupted. Another number may now be fed in via the data switch, and the programme restarted by means of the halt-reset switch. The next instruction is a jump command to 'LOOP'. LOOP is an address symbol, in this case a 'label', and labels are always followed by a colon (i.e. LOOP:).

The content of the PC is currently 000E, however this must be altered to 0007 (back to LOOP). The content of the PC must therefore be reduced by 0007 the value of the displacement of the jump-instruction thus becomes -07 or F9 (two's complement).

A part of the programme is now executed for the second time, the 'new' DS information is added to the previous result and the outcome displayed by the LEDs.

Finally, tables 4 and 5 give two further programme examples. Table 4 contains a programme which converts the microprocessor to a (software) binary counter. The LEDs display the counter output, the count being continuously incremented by 1. The programme in table 5 is for a 'running light'; beginning from the left the LEDs light up in succession, the whole cycle being continuously repeated.

Although it may seem rather an over-investment in hardware, using a microprocessor to light up a few LEDs, the point is, of course, that these programmes are intended to illustrate the operating principles and programming techniques of the microprocessor.

Experimenting with programmes such as those given above is by far the best way to come to grips with the challenge of microprocessor technology.

(To be continued)

Table 2

00xx = address RAM  
01xx = address LEDs  
02xx = address DS (data switch)  
(x = any value)

Table 2. The two highest bits of the first instruction byte determine which of the functional units is addressed.

Table 3. A simple programme for the addition of binary numbers.

Table 4. A programme to use the SC/MP as a binary counter.

Table 5. An example of a 'running light' programme.

Table 3

Add programme

START = 0000

0000	08	NOP	:
0001	C401	LOI 01	: load 01 into AC
0003	35	XPAH 1	: 01 in PTR 1 bit 8 . . . 15
0004	C402	LOI 02	: load 02 into AC
0006	36	XPAH 2	: 02 in PTR 2
		LOOP:	
0007	F200	ADD 0(2)	: add (EA) to (AC)
0009	C900	ST 0(1)	: (AC) in EA indicated by PTR 1,
000B	00	HALT	: and stop
000C	90F9	JMP LOOP	: jump to LOOP
		• ENO	: end of assembler instructions

Table 4

Binary counter

START = 0000

0000	08	NOP	:
0001	00	HALT	:
0002	C401	LDI 01	: load PTR 1 with EA
0004	35	XPAH 1	: of LEDs
0005	C400	LDI 00	: load counter, one
0007	C809	ST COUNTER	: RAM byte
		LOOP:	
0009	A807	ILO COUNTER	: increment counter
000B	C900	ST 0(1)	: 'store' counter state in LEOs
000D	8FFF	DLY X'FF	: delay instruction
000F	90F8	JMP LOOP	: jump to LOOP
		COUNTER:	: label and instruction to
		• 8YTE	assembler to reserve
		• ENO	• RAM byte

Table 5

Running light

START = 0000

0000	08	NOP	:
0001	00	HALT	:
0002	C401	LDI 01	: load EA of LEOs
0004	35	XPAH 1	: in PTR 1
0005	C401	LOI 01	: load 01 into AC
		LOOP:	
0007	C900	ST 0(1)	: (AC) in LEOs
0009	1 E	RR	: (AC) one bit to the right
000A	01	XAE	: store (AC) in E
000B	8FFF	OLY X'FF	: delay
000D	40	LOE	: (E) in AC
000E	90F7	JMP LOOP	: jump to LOOP
		• ENO	

#### Literature:

1. SC/MP data-sheet,  
pub. no. 420305227-001 A
2. SC/MP instruction guide,  
pub. no. 4200110 A
3. SC/MP technical description,  
pub. no. 4200079 A
4. SC/MP microprocessor applications  
handbook,  
pub. no. 420305239-001 A
5. SC/MP programming and assembler  
manual, pub. no. 4200094 B

# fields

In recent years there has been considerable interest in the effects of atmospheric electric and magnetic fields on living organisms, and in particular in their effect upon human health. For example, experiments carried out in West Germany into the effects of electric fields on motoring fatigue seem to indicate that the presence of an electric field inside a motor vehicle can reduce driver error.

The interior of a motor vehicle, because of its metal construction, is largely screened from external electric fields. Researchers from the West German Defence Ministry, the Max Planck Institute, and the Munich Institute for Biomedical Technology co-operated in developing a device to generate an electric field inside a car. It was found that, with the device operating, drivers made 8 to 10% less errors than normal. Furthermore, the more fatigued a driver was, the greater was the improvement in his performance when the device was switched on.

Professor König, of the Munich Technical University, writing in the German Motoring magazine 'ADAC-Motorwelt', stated that, '... electric and magnetic fields exert a biological influence upon the human organism'. On the other hand, Prof. Dr. Ir. Justus Bonzel, director of the Dusseldorf Research Institute of the Cement Industry, in reply to criticisms regarding the screening effect of concrete buildings, wrote, 'The question of the influence of electric fields upon humans and animals still remains unanswered,

and most scientists do not accept that a clear link exists. In spite of this, it is often asserted (and even pseudo-scientifically explained) that living in a concrete building has a negative influence on the health of the occupants, as a result of their being screened from electric fields which are present in the open air. (...) As far as the screening effect of building materials is concerned, it can be proven that materials such as high-quality concrete, brick, lime/sandstone and wood all screen or let through electric fields to virtually the same extent, and that the interiors of buildings made of these materials contain electric fields similar to those found in the open air.'

Which of these two conflicting viewpoints is true? Certainly, in view of the automobile experiments, it would appear that there is positive evidence that electric fields do have an effect upon health, and that the subject bears further investigation - so exactly what are atmospheric electric fields?

The ionosphere, which is a region of electrically charged air molecules, begins

at a height of approximately 70 km above the surface of the earth, and has a positive potential of 300-400 kV with respect to the earth. The ionosphere and the earth's surface thus act as the plates of a gigantic capacitor, which incidentally has a 'leakage current' of about  $3 \times 10^{-10} \mu\text{A}/\text{cm}^2$  due to movement of ions between the ionosphere and earth.

Between the ionosphere and earth there naturally exists a DC electric field, and in addition there is an AC field with a frequency of 10 Hz. The field strength is not uniform at all points between the ionosphere and earth, but at ground level in the open air the average field strength is about 130 V/metre. A diagrammatic representation of the ionosphere is given in figure 1.

Terrain and buildings have a considerable effect on local field strength at ground level. Figure 2 shows how the equipotential lines are 'cramped' closer together on hilltops, which means that the potential gradient and hence the field strength is greater there than in the valleys, where the equipotential lines are more widely spaced.

The potential difference between the ionosphere and earth causes a constant movement of ions between the ionosphere and earth. Near ground level positive ions predominate, there being approximately 2500 positive and 450 negative ions per cubic centimetre of air, although at sea these figures may be reduced by a factor of 10, and in urban areas may be increased by a factor of 10.

The ion concentration may also vary considerably with weather conditions. For example, before the onset of a thunderstorm there is a heavy ionic concentration with a predominance of positive ions. When rainfall occurs the concentration of ions quickly falls and the negative ions predominate.

It is believed that negative ions have a beneficial effect on health and positive ions a detrimental effect. This may explain the oppressive atmosphere that attends the onset of thunderstorms, and the subsequent relief when the rain begins.

In conclusion it is fair to say that there is sufficient evidence to warrant further research into the effects of electric fields and ions on human and animal health.

Figure 1. The ionosphere begins at a height of approximately 70 km and extends to about 1000 km. The ionosphere is charged to about 300-400 kV with respect to earth and the electric field causes constant movement of ions.

Figure 2. Electric field strength is greater at the tops of hills than in valleys, as can be seen from the bunching or expansion of the equipotential lines.

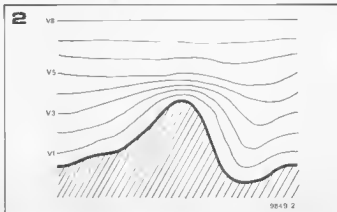
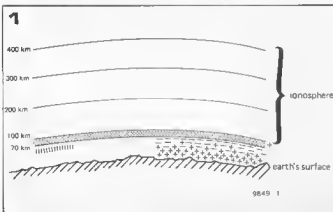

# electrometer

It should be noted at the outset that this instrument is not intended to give a quantitative measurement of field strength, but only to indicate the presence, and fluctuations in the strength, of an electric field. It should also be noted that other factors such as magnetic fields may influence the instrument.

## Principle of operation

When a body acquires an electric charge, then an electric field and a potential difference exist between it and earth and indeed between it and other (charged) objects. The geometry and strength of the electric field depend on the shape of the charged object, the potential difference, and the distance between the object and earth (or another object).

For example, consider the electric field between two large, flat parallel, conducting plates. The potential falls uniformly across the space between one plate and the other. It is possible to detect (or even measure) this so-called 'potential gradient' by inserting a pair of electrodes into the field and measuring the voltage difference between them.

Of course all this takes place in an insulating (dielectric) medium such as air, which has a very high resistivity, so any instrument used to measure the potential difference must have an extremely high input impedance. It is no use waving about the probes on one's multimeter and expecting to get a reading!

The input stage of the electrometer must therefore consist of a pair of electrodes feeding into an amplifier with a very high input impedance (figure 1). The amplifier output drives some form of indicator. As the present electrometer design is intended to give only a qualitative indication of field strength, it was felt that the expense of a meter was not justified, so an audible indication is provided.

The electrodes, which are etched on a piece of printed circuit board, are connected to the differential inputs of a FET input operational amplifier. The output voltage of the amplifier is used to control the frequency of a voltage-controlled oscillator (VCO), which

**Researchers into psychic matters believe that electric fields often accompany or are the cause of unusual phenomena. For example, it has been conjectured that buildings having certain geometrical shapes, such as pyramids, have the ability to concentrate electric fields and thus preserve organic tissues (mummification). This claim seems partly to be borne out by recent experiments in the USSR, where strong electric fields have been used to preserve vegetables and sharpen razor-blades.**

**It is also believed that electric fields accompany psychic manifestations. An instrument that will indicate the presence of an electric field is thus of considerable use when investigating such phenomena, and this is what the electrometer is designed to do.**

drives a loudspeaker. The VCO frequency is an indication of the field strength.

The smaller electrode between the two main electrodes serves as a balance electrode and a discharge path. Since the input impedance of the amplifier must be extremely high, it is not possible to reference the two inputs to zero or supply voltage by any resistive network. The input terminals are thus floating DC-wise with respect to the supply terminals, and it is possible that the common-mode range of the amplifier could be exceeded, even if the differential input voltage was quite small. The balance electrode is thus connected to half supply potential to provide a reference.

The balance electrode also serves as a discharge path for any static charges that may build up on the main electrodes. When using the electrometer the main electrodes should periodically be connected to the balance electrode to discharge them. Bridging the three contacts with a finger-tip will do the trick!

## Complete circuit

The circuit of the electrometer is given in figure 2. The input amplifier is a CA 3140 FET op-amp. Negative feedback to define the closed-loop gain is provided to one of the offset inputs via R3. (Providing feedback to the inputs, as is more usual, would lower the input impedance!). C1 provides high-frequency rolloff to maintain stability and prevent any high-frequency pickup.

The VCO is built around a 741 op-amp. This is connected as a voltage comparator, with the reference voltage on the non-inverting input determined by R5, R6, R7 and the output voltage of IC1. When the voltage on pin 2 is higher than the voltage on pin 3 the output will go low and C3 will discharge through R8. When C3 has discharged to such an extent that the voltage on pin 3 exceeds that on pin 2 then the output will go high and C3 will charge rapidly through D1. The output voltage will then go low and the cycle will repeat.

The output waveform of the VCO is thus a series of pulses having a very small duty-cycle, which keeps the cur-

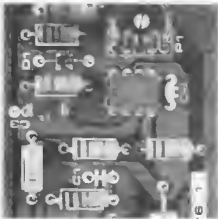

1

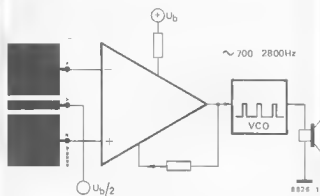

2

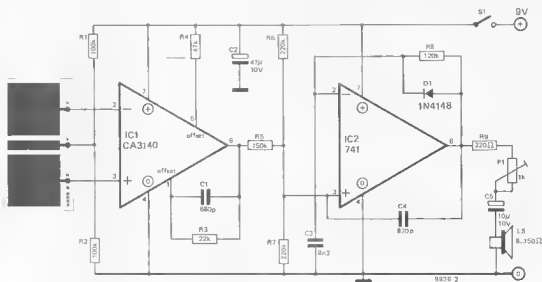
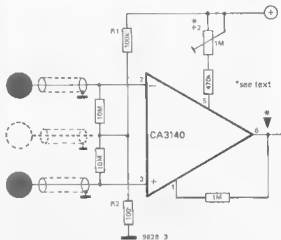

Figure 1. Block diagram of the electrometer, which consists of two sensor electrodes, a high input impedance differential amplifier, a VCO and a loudspeaker.

Figure 2. Complete circuit of the electrometer.

Figure 3. The input stage can be modified to monitor voltages generated by physiological changes such as muscle contraction.

3



rent consumption low and allows a 9 V transistor power pack battery to be used as the supply.

Potentiometer P1 in series with the loudspeaker provides some adjustment of the volume. For an 8  $\Omega$  loudspeaker P1 should be adjusted until the total resistance (P1 + R9) is around 390  $\Omega$ . The current consumption of the circuit will then be around 5 mA.

Printed circuit board and component layouts for the circuit and the sensor electrodes are given in figures 4 and 5.

### Testing and applications

When the electrometer is switched on, in the absence of an electric field, the instrument will produce a fixed tone. If an insulator such as an ebonite rod or piece of acrylic (which has been charged by rubbing on fur or other material) is brought close to the electrodes the pitch will change.

The electrometer can now be used to investigate electric fields around other bodies.

The electrometer may also be modified to indicate voltages generated during physiological changes such as muscle contraction, or the voltages generated by plants. These modifications are detailed in figure 3. The electrode plate is dispensed with and 10 M input resistors are connected into the circuit as shown. New electrodes, preferably of silver, are attached to the subject and connected via screened leads. In this case the centre electrode is optional, but if connected to the subject midway between the other two it will reduce the susceptibility to common-mode interference. To use the instrument, P2 is first adjusted until the output of IC1 is at half supply. The electrodes are then connected to the subject, either by taping to the skin over a muscle when



4

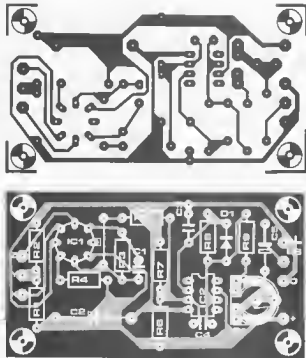

## Parts list:

## Resistors:

R1, R2 = 100 k  
 R3 = 22 k  
 R4 = 47 k  
 R5 = 150 k  
 R6, R7 = 220 k  
 R8 = 120 k  
 R9 = 220  $\Omega$   
 P1 = 1 k

## Capacitors:

C1 = 680 p  
 C2 = 47  $\mu$ /10 V  
 C3 = 8n2  
 C4 = 820 p  
 C5 = 10  $\mu$ /10 V

## Semiconductors:

IC1 = CA 3140  
 IC2 = 741  
 D1 = 1N4148

## Miscellaneous:

S1 = SPST switch  
 LS = loudspeaker  
 B... 150  $\Omega$

5

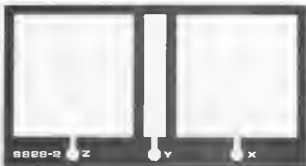

Figure 4. Printed circuit board and component layout for the electrometer. (EPS 9826-1)

Figure 5. The sensor electrodes, which are also etched on copper laminate board.

monitoring muscle contractions, or by taping to the leaves or stem of a plant. When the muscle is flexed the pitch of the VCO will change, or in the case of plants there may be a response to stimuli such as light, heat or even sound. Whatever application the electrometer is used in, it should be remembered that the instrument is fairly sensitive and has a high input impedance, and is thus very susceptible to interference such as mains hum. It should therefore preferably be used well away from such sources of interference



an invitation to investigate, improve on and implement imperfect but interesting ideas.

## relaxation generator

Recent medical research carried out in Belgium has come up with a novel and intriguing method of treatment for patients suffering from tension and stress. The treatment consists of letting the patients listen to the high frequency components of certain sounds, in particular that of their mother's voice, and, curiously enough, of Mozart.

The method, which is propounded by Dr. W. Michiels, is based upon the patients re-acquiring their ability to perceive high frequency sounds. The loss or impairment of this faculty is, according to Dr. W. Michiels, a contributory factor in the genesis of tension and stress. The argument states that the

unborn child first begins to perceive sounds during the fifth month of pregnancy. Its perception of sound when in the womb however, differs radically from that after birth. When still in the womb, the child is surrounded by amniotic fluid which filters out all the low frequencies (below 8000 Hz) before they reach the child, so that it only hears the higher frequency components and the sounds of the mother. The change in the child's environment which takes place at birth, however, means that it gradually becomes accustomed to hearing sounds below 8000 Hz, and slowly loses the ability to perceive the higher frequencies. By repeatedly exposing the patient to frequencies above 8000 Hz he is, so to speak, returned to his pre-natal phase in the womb. Gradually the brain relearns to perceive and process these higher frequency impulses.

If possible, the mother's voice should be used in the treatment; if this is not feasible however, then the music of Mozart may be used instead. Mozart composed at a very young age, and for the rest of his life, his music contained a lot of high notes. According to Dr. Michiels, Mozart is the only composer suitable for this method of treatment.

The treatment itself extends over a considerable period of time, 50 hours over some six months if the mother's voice is available, otherwise 100 hours of Mozart. A preliminary investigation, which consists of a listening test, is carried out to establish the extent and nature of the patient's tension, and whether he has an open or a closed 'selectivity'. If the latter is the case, the patient's condition is regarded as being the result of his own nature. If, however, he has an open selectivity, then his condition is a result of his immediate environment, work situation etc. . In the initial phase, two or three sessions of two hours are carried out per week using headphones.

### The circuit

The sort of filter required is a highpass filter with as steep a filter slope as

possible and a number of switchable break points (3 dB-points); the highest break point should be 8 kHz. Such a filter was discussed in the article 'Active loudspeaker crossover filters' in Elektor 25 and 26 in figure 2b and table 4. The circuit diagram of this filter is shown in figure 1.

A 3-pole switch with as many positions as possible is required. In position 1 of the switch the filter remains inactive, whilst in position 11 the cut-off frequency is nominally 7620 Hz.

Intermediate cut-off frequencies can be obtained by proportionate increases in the value of the three capacitors. The circuit has a high input impedance and low output impedance, and can be situated anywhere in the pre-amp. The simplest method is to utilise the tape output and tape monitor input.

N.B. It should be borne in mind that overexposure to intense noise can cause damage to the ears. It is recommended that care should be taken when experimenting with the above-described method of treatment, and readers should realise that the experiments referred to in this article were conducted under expert medical supervision.

1

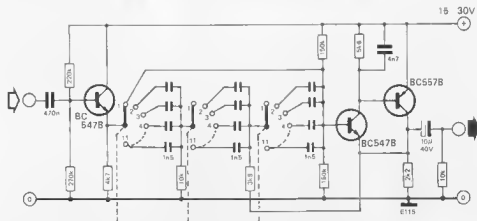

# ccir tv pattern generator (3)

Since many waveforms have already been derived from the clock and divider train in order to synthesise the sync waveform, it is relatively easy to put some of these to use in the pattern generator, and a total of 10 different patterns can be generated using only a simple circuit. These patterns are: — horizontal lines, vertical lines, cross-hatch, dot, broad and narrow horizontal bars, broad and narrow vertical bars, large and small chequerboard patterns.

## Vertical patterns

Since a number of waveforms already exist at multiples of line frequency, generation of patterns of vertical bars and lines is a very simple matter. The vertical line pattern shown in photo 1 results simply by taking the output of N39 in figure 4 of last month's article. Similarly, the narrow vertical bars shown in photo 2 are obtained by taking output Q4 of the divider chain, and the broad vertical bars are obtained, not surprisingly, by taking output Q5.

## Horizontal patterns

Generation of horizontal patterns is slightly more difficult; the outputs of the 625 counter that counts lines are asymmetric during odd and even fields and cannot be used to derive any stable patterns. Because of this a separate counter is used as shown in figure 1. This is a six-bit counter consisting of a 7493 hexadecimal counter and a 7473 dual JK flip-flop; it takes its clock input from output Q8 of the timebase divider chain which is at line frequency.

In order to maintain a stable pattern the counter must be reset at the beginning of each field, and this is accomplished by feeding the 25H signal into the 7493 reset inputs (IC29) and 25H into the 7473 clear inputs (IC30), since this requires a reset signal of opposite polarity.

Horizontal lines, shown in photo 4, are obtained by feeding all four outputs of the 7493 into a four-input NAND-gate N87. The output of this gate will go low only when all four outputs of the counter are high, which occurs once every 16 clock pulses. This output thus goes low for one line period every 16 lines.

Having completed those sections of the circuit that produce the CCIR standard sync signal, attention is now given to the design of the pattern generator module, which will turn the instrument into a versatile aid to TV adjustment and servicing.

It is possible to obtain a closer spaced horizontal line pattern by replacing the 7493 by a 7490. Since this IC will only count to 10 the condition where all outputs are high (count 15) is never reached. To avoid the horizontal pattern being inhibited the connection to pin 10 of N87 must be broken, leaving it permanently high, and the output will then go low on count 7 of IC29.

The narrow horizontal bar pattern (photo 5) is obtained by dividing the output of the 7493 by two in FF1. The output of this flip-flop is high for 16 line periods and low for 16 line periods. Dividing the output of this flip-flop by two again in FF2 gives the broad horizontal bar pattern (photo 6), the output being high for 32 line periods and low for 32 line periods.

## Crosshatch, dot and chequered patterns

The remaining patterns are obtained by combining these basic horizontal and vertical patterns in various ways. The manner in which this is accomplished depends on two factors:

- in which logic state the patterns to be combined are 'active', and
- the required polarity of the resulting video signal.

For example, the horizontal line output from N87 is active in the low state, i.e. when a line appears on the screen the output of N87 is '0'. If the normal video signal is taken as positive then this would give black lines on a white background. Of course, to give white lines on a black background all that is required is to invert the signal, and in fact provision is made for this in the circuit. The inversion facility is not really required for those patterns that are basically symmetric such as the bar and chequerboard patterns, since inverting these patterns merely has the effect of shifting the pattern slightly on the TV screen. However, for the line, dot and crosshatch patterns it can be useful to have the choice of white pattern on black background or vice versa.

The crosshatch pattern is obtained simply by feeding the horizontal and vertical line pattern signals into NAND-gate N88. If either the horizontal or

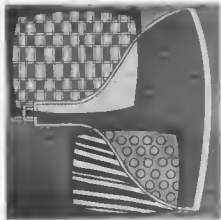

1

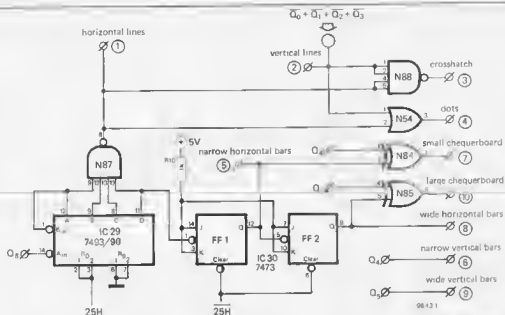

Figure 1. The circuit of the pattern generator is relatively simple since many of the vertical patterns are obtained direct from the timebase/divider chain and sync generator, so the circuit is mainly for the derivation of horizontal patterns and combination patterns.

2

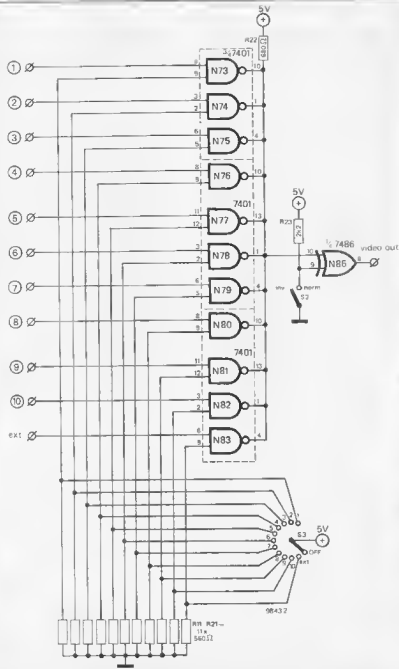
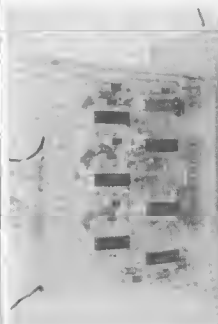
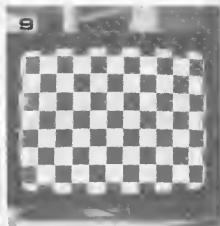
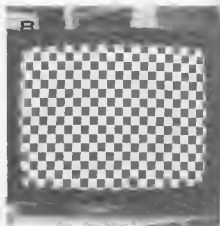
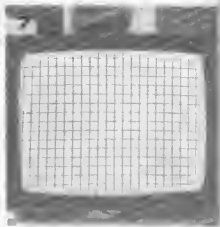
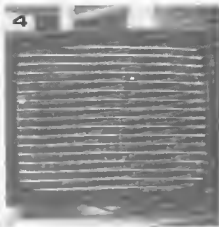
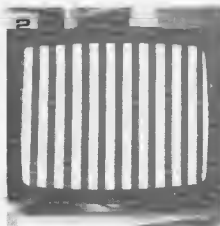
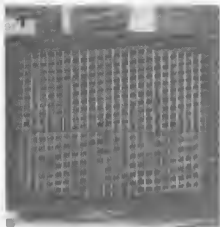

Figure 2. Pattern selection is accomplished by means of AND-gates with a wired-OR output. This is preferable to simply using the switch layout to select signals direct, since the length and layout of wiring to the switch cannot affect the quality of the signals. S2 allows normal or inverted versions of the patterns to be selected.





vertical line signal (or both) is active (low) then the output of N88 is high. However, when both the horizontal and vertical line signals are high the output of N88 is low. This means that the crosshatch pattern is inverted with respect to the horizontal and vertical line signals i.e. when they are black on a white background the crosshatch will be white on a black background (cf. photos 1, 4 and 7).

The dot pattern, which is the only one not shown in the photos, consists of dots whose positions correspond to the intersections of the horizontal and vertical lines. This means that the dot signal must be active only when the horizontal and vertical lines are both active, i.e. at the intersections. This is achieved by feeding the horizontal and vertical signals into an OR-gate (N54). If either of these signals is high then the

Photos 1 to 9. A selection of the patterns generated by the circuit, namely:— 1 vertical line; 2. narrow vertical bar; 3. wide vertical bar; 4. horizontal line; 5. narrow horizontal bar; 6. wide horizontal bar; 7. crosshatch; 8. small chequerboard; 9. large chequerboard. The dot pattern is not shown here.

Figure 3. Printed circuit board end component layout for the pattern generator module. (EPS 9800-3)

#### Parts list to figure 3:

##### Resistors:

R10 = 1 k  
R11 ... R21 = 560  $\Omega$   
R22 = 680  $\Omega$   
R23 = 2k2  
R112 ... R118 = 4 $\Omega$ 7 (see also part 1)

##### Capacitors:

C112 ... C118 = 120 n (see also part 1)  
C131 ... C137 = 10 n

##### ICs:

IC24 ... IC26 = N73 ... N83 = 3 x 7401  
IC27 = N84 ... N86 = 7486  
IC28 = N87, N88 = 7420  
IC29 = 7493 (or 7490, see text)  
IC30 = 7473  
N54 is part of IC16 (7432), see part 2.

output of N54 will be high, and the output will only be low when both inputs are low. The dot pattern has the same polarity as the line patterns.

The small and large chequerboard patterns are obtained by combining the relevant horizontal and vertical bar patterns in exclusive-OR gates (N84 and N85). When the inputs of the EXOR gate are both the same (i.e. a horizontal black bar overlaps a vertical black bar or a white bar overlaps a white bar) then the output will be low, when they are different the output will be high.

Of course, as mentioned earlier, the polarity of the chequerboard patterns (or indeed the bar patterns) is not particularly important, since changing the black squares to white and vice versa merely shifts the pattern on the screen.

### Pattern selection

All the patterns are, of course, available simultaneously, at the outputs of their respective gates, so there must be provision for selecting which pattern is fed to the video mixer. For this the circuit of figure 2 is used. Each signal is fed to one input of a NAND-gate, the other input of which is normally pulled low by a 560  $\Omega$  resistor, thus blocking the signal until that particular pattern is selected by S3. The NAND-gates have open collector outputs so their outputs can be joined to perform a wired-OR function.

Exclusive OR-gate N86 selects between normal and inverted display of the patterns. With S2 open, pin 9 is pulled high, so a high input on pin 10 will produce a low output and vice versa. With S3 closed, pin 9 is pulled low, so a high input will produce a high output according to the exclusive-OR function. N83 makes provision for an external input signal to be fed into the video mixer or, if no input is fed in, a blank raster may be obtained, which is useful for checking colour purity and balance.

### Construction

The pattern generator is mounted on a second module that plugs into the motherboard.

Construction is quite straightforward and should pose no problems. Connections to switches S2 and S3 are all brought out to the top edge of the p.c. board, together with the external input connections. Connection to the motherboard can be made using ITC-Cannon GO-9 series connectors. The sockets in their grey plastic moulding are soldered to the motherboard, while the pin strip is soldered to the module. The component side of the module faces the component end of the motherboard.

### Testing

The output of the video mixer can be fed into the video amplifier of a TV that is known to be working, and the generator may then be checked for the

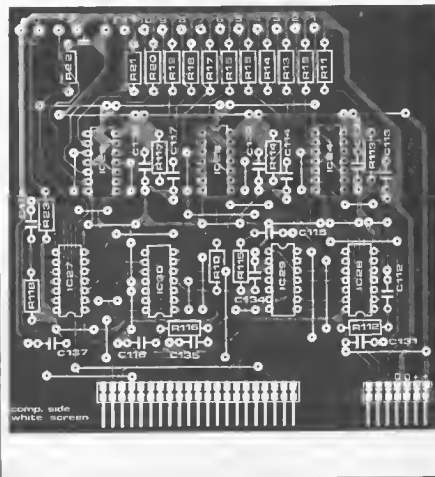
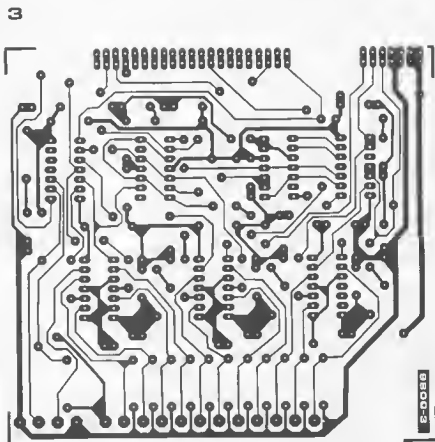

correct production of all the patterns. As with many digital circuits in the event of a fault occurring the only really efficient method of troubleshooting is to use an oscilloscope. Figures 10 and 11 illustrate the type of waveforms that should be available at the output of the video mixer. Figure 10 shows the horizontal line signal on the lower trace, with the 25 Hz signal shown on the upper trace as a reference and also used for vertical triggering of the oscilloscope. Figure 11 shows the large amplitude pattern with the line blanking signal on the upper trace.

### Conclusion

In the near future it is hoped to publish a design for a modulator that will allow the output of the pattern generator to be fed directly into the aerial input of a TV set. Looking further into the future, it is also intended to publish further extensions to the pattern generator as soon as possible.



12



Photo 10. Oscilloscope of the horizontal line pattern video signal.

Photo 11. Oscilloscope of the large amplitude pattern video signal.

Photo 12. The ITC-Corona GD-9 seven core headers used to join the modules in the methodical.

The title of this article should really be 'remote-controlled poltergeist-mitator'. By operating a miniature ultrasonic transmitter concealed for example in one's jacket pocket, a receiver hidden somewhere in the room will simulate the sound of a poltergeist loose in the house. Should the authentic poltergeist then fail to put in an appearance, the ambitious ghost hunter can ensure success by virtue of his electronic stand-in.

The idea behind this article is not to put the poltergeist out of a job, but rather to provide a little anecdotal fun for those of our readers inclined to practical jokes.

The miniature ultrasonic transmitter which is concealed on the person of the user consists of a handful of components and the current consumption is negligible (approx. 0.3 mA). When the receiver, which is hidden somewhere in the same room, picks up the ultrasonic signal from the transmitter an indicator generator is activated. A loudspeaker then audibly signals the presence of one's evil visitor: the poltergeist. The maximum transmission range is approx. 4 to 5 metres.

### The transmitter

As is apparent from Figure 1, the ultrasonic transmitter requires little more than one IC type 4011 and an ultrasonic transducer.

The four gates of the IC are used to form two stable multivibrators: the frequency of the first (N5, N6) is approx. 1 Hz, whilst that of the second (N7, N8) is roughly 40 kHz. Closing S1 starts the first AMV which triggers the second AMV at 1 second intervals. The second AMV then produces a burst of 40 kHz ultrasonic sound lasting only a few milliseconds. As a glance at the circuit diagram makes clear, the circuit is ideally suited for miniaturisation, as

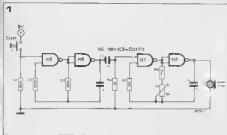

2a

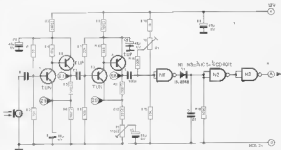

already sectioned the current coil structure is so small as to be negligible.

**The receiver**

Figures 2a, 2b and 2c show the circuit diagram of the receiver. The input signal is fed to a two-stage amplifier each stage consisting of a pair of DC-coupled transistors. The gain of the second stage (T3/T4) is greater by means of P1. The total gain should not be set higher than is necessary to ensure good reception otherwise the receiver becomes over-sensitive and prone to interference.

To prevent the circuit being triggered by spurious pulses, the amplifier is followed by a voltage comparator with an adjustable threshold (N1/R15/P2 and N1). The trigger threshold may be varied by means of P1, and the best setting for this potentiometer should be determined experimentally.

Once the signal has passed the trigger stage it is received, then buffered by N2 and N3 before being fed to the audio amplifier N4 (figure 2b). The gain is connected as an inverter, and feedback is applied via a twin T filter network. At the resonant frequency  $f_0$  the phase shift of the twin-T network is 180°, so that the stage will oscillate at this frequency.

P3 should be adjusted so that the audio generator just fails to oscillate under quiescent conditions. Only when the oscillator receives a trigger pulse from N3 will it produce an output in the form of a decaying oscillation. With the component values shown, the resultant sound is similar to that of someone rapping their knuckles on a wooden table. The tone of the sound can be altered by varying the values of R15, R19, R23, C18, C11 and C13. Finally IC2, T5 and T6 form a very simple audio amplifier which drives an 8 Ω loudspeaker (figure 2c). The output power of 2.5 watts may appear a little

2b

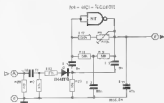

2c

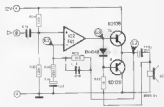

modest, however the resulting sound will bear full comparison with anything even the most workhorse of portable cassette players.

Figure 1 The input stages of the pre-amplifier. The frequency of the ultra-high signal can be adjusted by means of potentiometer P1, to find the position from which the signal is received.

Figure 2 The circuit diagram of the receiver. Both Value and Murata ceramic transistors are suitable for the transmitter and receiver.



# video biofeedback

Anybody who is interested in electronics will have at least a fair idea of what 'feedback' is. Speaking very broadly, it can be described as 'feeding (information from) the output of a system back to its input, often with the objective of reducing errors and increasing performance'. In essence, in other words, the system either 'knows' or 'is told' what it should be doing; the feedback information 'tells it' what it is actually doing; by comparing the two, it can attempt to make its actual performance conform more closely to the ideal.

This description is intentionally broad, so that it can also be applied to other systems as well as electronic circuits. In its application to living organisms, and in particular human beings, the concept has become known as 'biofeedback'.

Biofeedback consists of the monitoring of various physiological functions and presenting the results to the subject being monitored. This is obviously not an end in itself; the object is to achieve regulation on these functions by conscious control. Many functions can be regulated, including those which, until recently, it was thought were wholly under the control of the autonomic nervous system and thus not subject to conscious regulation. Such functions include pulse rate, blood pressure, body temperature and, of course, brain activity.

The achievement of conscious control of physiological processes is known as autogenic training. Although the application of electronic biofeedback techniques to autogenic training is relatively new, autogenic training has been practised in the East for thousands of years (Yoga).

In the West interest in autogenic training began at the turn of the century. The neurologist Oskar Vogt discovered that some patients who had participated in sessions of hypnosis were able to put themselves into a trance, and after repeating this several times experienced a sense of increased physical well-being with a disappearance of symptoms of nervous tension and stress.

The technique of autohypnosis was further developed by J.H. Schulze, who devised a training programme to enable

**In recent years the use of biofeedback techniques to achieve conscious control of brain activity has become extremely popular.**

**Of particular interest is 'alpha feedback' which, by stimulating the production of alpha-waves, promotes relaxation. Many designs for alpha monitors have been published, but most of these have provided an audible output.**

**As the brain is better equipped to respond to visual stimuli, the design presented here provides a visual output on a TV screen.**

patients to improve their state of health, and the term 'autogenic training' was coined to describe Schulze's method.

Advocates of autogenic training maintain that the following aims can be achieved:

- Muscular relaxation
- Control of pulse rate
- Control of body temperature
- Control of brain activity

all of which combat stress and nervous tension and promote more rapid and refreshing sleep.

## Brain rhythms

Schulze discovered that patients who had progressed sufficiently in his autogenic training program could reach an even deeper state of trance by means of 'meditation'. This would hardly come as a surprise to many Orientals . . .

One good way of reaching this state was found to be initiated by turning the eyes up and 'within'. This is also clearly reminiscent of certain Yoga techniques! Much later it was discovered that this technique is one of the ways of stimulating the brain to produce so-called alpha-waves. The implications of this discovery are perhaps not earth-shaking, but it helped to forge a link between Oriental meditation and Western technology. It is known that the brain generates regular electrical impulses in four principal patterns that are associated with different modes of brain activity.

- Alpha waves have a frequency between 8 Hz and 12 Hz and are associated with physical relaxation in the waking state.
- Beta waves have a frequency between 13 Hz and 30 Hz, and are associated with a high level of audio-visual stimulation and a state of tension or excitement.
- Delta waves, which have a frequency between 0.5 Hz and 3 Hz, are the predominant rhythm during sleep.
- Theta waves occur during activities of a creative nature, and have a frequency between 4 Hz and 7 Hz.

In normal cases, closing eyes and relaxing should cause the brain to slowly shift from beta-activity to alpha. Some people have extreme difficulty in

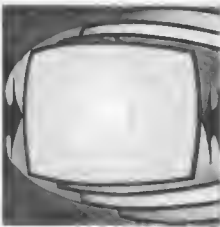

1

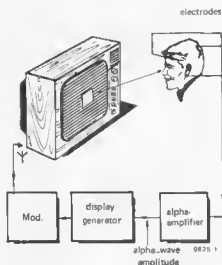

Figure 1. Block diagram of the video-biofeedback system. The alpha amplifier filters and amplifies alpha waves from the brain, and the output of the alpha amplifier drives a display generator which produces, on a TV screen, a rectangle whose size is proportional to the alpha amplitude.

2

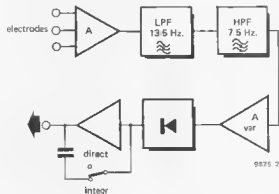
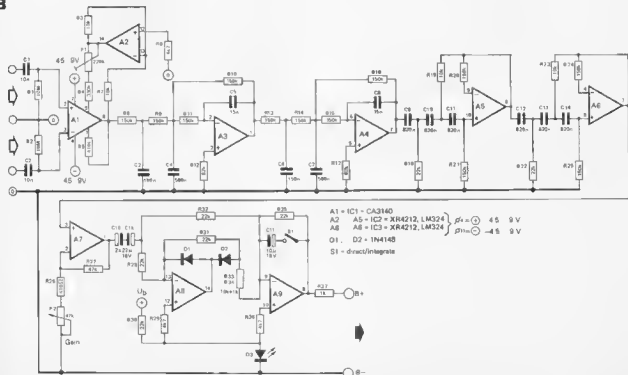

Figure 2. Block diagram of the alpha amplifier, which consists of a high impedance amplifier, low- and highpass filters, a variable gain amplifier and a rectifier stage. A switchable integrator provides the option of fast or slow response to changes in alpha amplitude.

Figure 3. Complete circuit of the alpha amplifier.

3



4

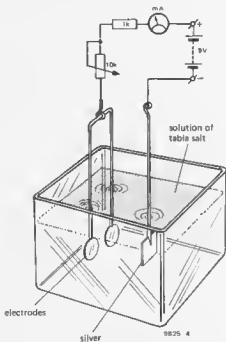

achieving this, however; they remain in a state of tension. The Oriental solution to this problem is meditation exercises; the best-known Western solution is the sleeping-pill.

Recently, it has been discovered that biofeedback training can be used to produce similar results: the brain 'learns' to produce alpha-waves with their associated sensation of relaxation and well-being.

### Alpha feedback

The amplitude of the different brain rhythms increases with the intensity of the particular mental state associated with the rhythm. Thus, in the case of alpha waves the alpha amplitude is at a maximum when a person is most relaxed.

In order to practise alpha feedback training to achieve relaxation and tranquility it is necessary to monitor the alpha amplitude and present this information to the subject. In essence then, an alpha monitor must consist of an 8 to 13 Hz selective filter-amplifier that will pass only alpha rhythms, and some form of display to indicate the alpha amplitude.

In the present design a TV screen is used as the display medium (figure 1). A rectangle is generated in the middle of the screen. The size is proportional to the alpha amplitude and hence to the degree of relaxation of the subject. The objective of the alpha feedback training is therefore to attempt to relax in order to make the rectangle expand until it fills the whole of the screen.

Although alpha rhythms are easier to generate with the eyes closed, and initially it may be difficult to produce them with the eyes open, this small disadvantage is offset by the improved response which visual feedback provides.

### Alpha detection

Figure 2 shows a block diagram of the alpha amplifier, which produces a DC output voltage proportional to the alpha amplitude. Electrical impulses from the brain are picked up by electrodes attached to the scalp and are amplified before being fed to a lowpass filter, which removes frequencies above 13.5 Hz and a highpass filter, which removes frequencies below 7.5 Hz. The resulting signal, which is now predominantly alpha waves, is then fed to a variable gain amplifier, the output of which is rectified to provide a DC voltage proportional to the alpha amplitude. If desired the DC voltage can be fed direct to the display to provide a rapid response to changes in alpha amplitude, or via an integrator to provide a slower response.

Figure 3 shows the complete circuit of the alpha amplifier. It consists of a high impedance differential amplifier (A1) feeding a lowpass filter comprising two third order filter sections (A3 and A4), which in turn feeds a highpass filter

5

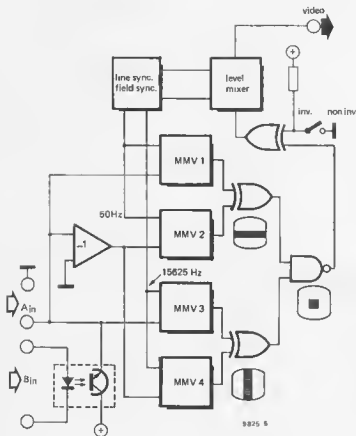

comprising two third order sections (A5 and A6).

Since it was felt that the high cost of a fixed gain, high input impedance, instrumentation amplifier for A1 was not justified, some method had to be found of defining the closed-loop gain of an inexpensive op-amp, without compromising the input impedance. It was not possible to achieve the high input impedance required if normal feedback to the input were used, since this would demand impossibly high feedback resistors. The solution chosen here was to use a relatively inexpensive CA3140 FET op-amp and to provide negative feedback to the offset inputs via A2. The input resistance is now determined solely by R1 and R2.

The output of the final highpass filter stage, A6, feeds the variable gain amplifier A7. Potentiometer P2 varies the gain of A7, and thus the sensitivity of the amplifier, so that signal levels from about  $6 \mu\text{V}$  to  $600 \mu\text{V}$  can be processed.

The final stage of the alpha amplifiers consists of an active rectifier constructed around A8, to convert the alpha waves to a D.C. signal, followed by a buffer A9, which provides the option of a direct or integrated signal. The integrated signal is preferable for the TV display since it provides a more stable picture.

For safety reasons the alpha amplifier is coupled to the display generator via an opto isolator, so that there is no danger of electric shock in the event of an insulation breakdown between the TV set and the display generator, or in the display generator itself. Since the opto-isolator will only function if the voltage applied to it is above the knee voltage of its LED, it must be provided with a forward bias even in the absence of an input signal. To this end LED D3 is included in the circuit to provide a permanent positive offset at the output of A9.

## Electrodes

The alpha amplifier input is provided by three electrodes, one of which is attached to the forehead, another to the back of the head, and the third (earth) electrode to one of the earlobes. To avoid electrolytic voltages being produced, all three electrodes should be of the same material. Stainless steel will give acceptable results, but the best material is silver or silver-plated copper. Since such electrodes are not readily available commercially, the best plan is to have a jeweller or silversmith make several small discs of approximately 8 mm diameter. The two input electrodes can be soldered onto leads and can be secured to the head using a headband of insulating material. Note that the electrode at the back of the head should make good contact with the scalp! The earth electrode can be made by soldering two of the silver plates to a small crocodile clip which can be clipped onto the earlobe.

6



7



Figure 4. The silver electrodes are coated with silver chloride using this setup, to provide an electrolytically inactive layer between the electrodes and the skin.

Figure 5. Block diagram of the video display generator. To avoid the danger of electrical shock in the event of a malfunction, there is no direct electrical connection between the alpha amplifier (which is battery powered) and the display generator. The signal is transferred using an opto-isolator.

Figure 6. The pulse length of MMV1 is always longer than that of MMV2, so when the two pulses are combined in an EXOR gate the output is high when the MMV2 pulse has finished but the MMV1 pulse is still high. The same applies to MMV3 and MMV4.

Figure 7. The rectangular display is obtained by combining the horizontal and vertical bars in a NAND gate.

Figure 8. MMV1 (P6) controls the lower edge of the rectangle, MMV2 (P5) controls the upper boundary, etc.

8



Despite the use of silver electrodes it is still possible for voltages to be generated electrolytically due to differences in chemical conditions on the skin in the contact areas. It is therefore necessary to coat the electrodes with an electrolytically 'neutral' layer of silver chloride. The setup to carry out this operation is shown in figure 4. A solution is made consisting of 0.9% by weight pure sodium chloride (refined table salt is suitable) dissolved in 99.1% by weight distilled water. The electrodes are then immersed in this solution together with another silver plate to act as the cathode and plated at a current density of 1 mA/sq. cm. for about one hour, after which time they should be coated with a dark deposit of silver chloride. In the example shown using 8 mm diameter discs, the area of each disc is about  $0.5 \text{ cm}^2$  per side, so the total area of the two discs is  $2 \text{ cm}^2$ , and the pot. should thus be adjusted to give a current of 2 mA.

In order to reduce contact resistance to an absolute minimum, the electrodes should ideally be coated in a special conductive paste before connection to the skin. However, this is again not readily obtainable, and a heavily salted starch paste will prove adequate for the present application.

After use the electrodes should be carefully washed with distilled water to avoid deterioration of the chloride layer. Should this layer become damaged for any reason it must be restored by repeating the chloration procedure.

## Display generator

A block diagram of the display generator is given in figure 5. At the top left of the diagram are line and field sync oscillators, which produce 15625 Hz and 50 Hz waveforms to synchronise the TV raster.

The output of the field sync oscillator also triggers two voltage-controlled monostable multivibrators MMV1 and MMV2. The pulse duration of MMV2 is always less than that of MMV1 (see figure 6). The outputs of MMV1 and MMV2 are fed to an exclusive OR gate, the output of which will go high only when the two inputs are different, which in this case means when the output pulse of MMV2 has terminated but that of MMV1 is still high. The result is that the output of the EXOR gate is high for a certain time in the middle of a field scan, and this would produce a horizontal bar across the screen. However a pair of monostables MMV3 and MMV4 are triggered by the line sync output and their outputs combined in an EXOR gate to produce a vertical bar display.

The required display is a rectangle which occupies the area where the two bars overlap (figures 7 and 8), and this is achieved by combining the two EXOR outputs in a NAND gate. The output of the NAND gate, together with line and field sync pulses, is fed to a video mixer to produce a composite video signal.

An EXOR gate and switch provide the option of normal or inverted video signal i.e. a white rectangle on a black background or a black rectangle on a white background.

MMV1 is controlled directly by the output of the opto-isolator, so that as the output of the alpha amplifier increases the pulse length of MMV1 increases. MMV2 is connected to the output via an inverting amplifier, so that as the alpha output increases the MMV2 output pulse length decreases. The same is true of MMV3 and MMV4, and the effect is that as the alpha amplitude increases the rectangular display increases in size.

### Display generator circuit

Figure 9 is the complete circuit of the display generator. The line and field sync generators, IC1 and IC2, are 555 times connected as astable multivibrators. The line and field sync frequencies may be adjusted by means of P1 and P2; the adjustment ranges are sufficient to allow for both the originally intended 625 line/50 Hz and the alternative 525 line 60 Hz systems. For the 625 line system, the required period times are shown in figure 10.

The internal block diagram of a 555 is shown in figure 11. Its output is high during the charging time of the capacitor,  $t_1 = 0.7 \cdot (R_A + R_B) \cdot C$ ; it is low for the discharge time  $t_2 = 0.7 \cdot R_B \cdot C$ . For both AMVs,  $t_2$  is the duration of the corresponding sync pulse as specified in figure 10. The total period time  $t_1 + t_2$  is more critical, however; for this reason  $R_A$  is replaced by a preset potentiometer in series with a fixed resistor in the final circuit. These presets are simply adjusted until a stable picture is obtained.

9

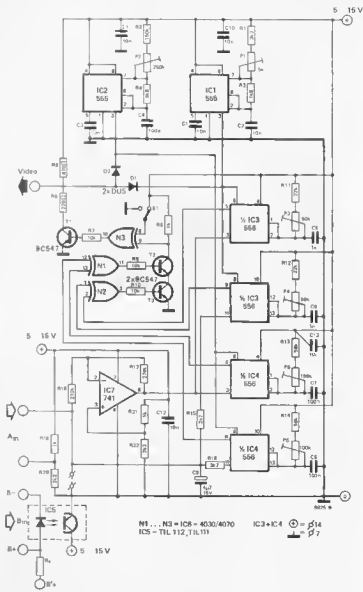

10

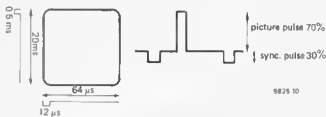

11

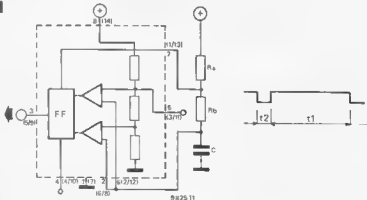

12

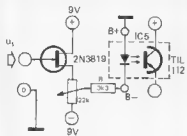

9826 12

Figure 9. Complete circuit of the display generator.

Figure 10. The amplitude of the video waveform varies between about 30 and 100% supply voltage during a line period, but during line or field blanking intervals it is clamped to about 0.6 V.

Figure 11. Showing the internal circuit of a 555 (or  $\frac{1}{2}$  556) timer, and how it is connected as an astable multivibrator. The pinning shown in brackets refers to the (two halves of a) 556 timer.

Figure 12. This high-impedance front-end can be used for testing the display generator. It can also prove useful if the generator is to be driven from a high-impedance source.

Figure 13. Printed circuit board and component layout for the alpha amplifier shown in figure 3 (EPS 9825-2).

13

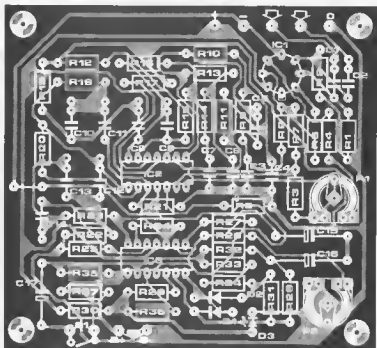
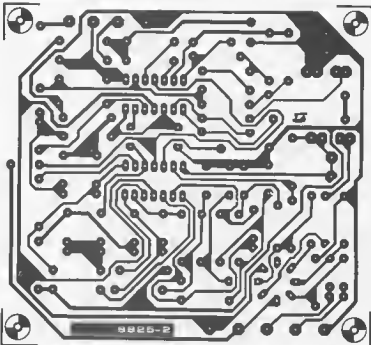

Parts list to figures 3 and 13.

## Resistors:

R1, R2 = 10 M  
 R3, R7, R19, R23 = 10 k  
 R4 = 330 k  
 R5 = 470 k  
 R6, R29, R36 = 4k7  
 R8, R9, R10, R11, R13, R14, R15,  
 R16, R20, R21, R24, R25 = 150 k  
 R12, R17 = 82 k  
 R18, R22, R28, R30, R31,  
 R32, R35 = 22 k  
 R26 = 470  $\Omega$   
 R27 = 47 k  
 R33, R34 = 11 k (10 k + 1 k)  
 R37 = 1 k

## Capacitors:

C1, C2 = 10 n  
 C3, C6 = 150 n  
 C4, C7 = 560 n

C5, C8 = 15 n

C9 ... C14 = 820 n  
 C15, C16 = 22  $\mu$ /16 V  
 C17 = 10  $\mu$ /16 V

## Semiconductors

A1 (IC1) = CA 3140  
 A2 ... A5 (IC2) = XR 4212 or  
 LM 324  
 A6 ... A9 (IC3) = XR 4212 or  
 LM 324  
 D1, D2 = 1N4148  
 D3 = LED

## Miscellaneous:

P1 = preset 220 k  
 P2 = preset 47 k lin.  
 S1 = switch SPST

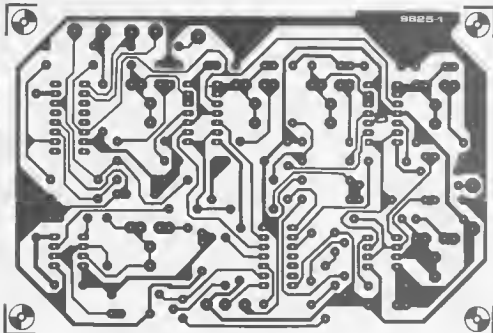

Parts list to figures 9 and 14.

**Resistors**

R1 = 3k3  
 R2 = 150 k  
 R3 = 1k8  
 R4 = 6k8  
 R5 = 470  $\Omega$   
 R6 = 220  $\Omega$   
 R7, R9, R10 = 10 k  
 R8, R19, R21 = 1 k  
 R11, R12 = 22 k  
 R13, R14 = 56 k  
 R15, R16 = 2k7\*  
 R17, R18 = 270 k  
 R19, R21 = 1 k  
 R20, R22 = 2k2

\* Nominal value. Depending on IC tolerances, optimally smooth control of boundaries 1 and 3 may be obtained with slightly different values for these resistors.

**Capacitors:**

C1, C2, C3, C10, C11, C12,  
 C13 = 10 n  
 C4, C7, C8 = 100 n  
 C5, C6 = 1 n  
 C9 = 4 $\mu$ 7/16 V

**Semiconductors:**

IC1, IC2 = 555  
 IC3, IC4 = 556  
 IC5 = TIL 111 or TIL 112  
 IC6 = 4030 or 4070  
 IC7 = 741  
 T1, T2, T3 = BC 547  
 D1, D2 = DUS

**Miscellaneous:**

P1 = preset 6 k  
 P2 = preset 250 k  
 P3, P4 = preset 50 k  
 P5, P6 = preset 100 k  
 S1 = switch SPDT

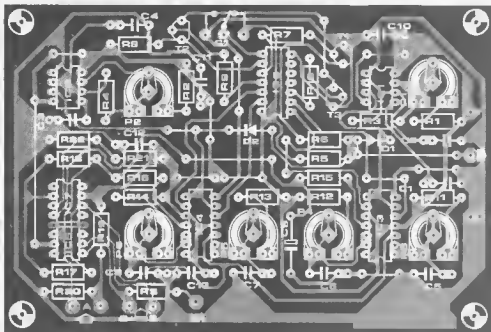

The field sync oscillator triggers two monostables corresponding to MMV1 and MMV2 in the block diagram, which are built around a 556 dual timer IC4. Similarly, the line sync oscillator triggers two monostables built around IC3, and corresponding to MMV3 and MMV4 in figure 5.

The two EXOR gates connected to the MMV outputs are N1 and N2, while the NAND gate is made up from two discrete transistors T2 and T3. This is to avoid the necessity for an extra

NAND gate IC. The EXOR gate that provides for selection of normal or inverted display is N3, and this drives T1, which forms part of the video mixer. During the field and line blanking intervals, the outputs of IC1 or IC2 go low, pulling down the video output to about 0.6 V via D1 or D2. At all other times however, the outputs of IC1 and IC2 are high; D1 and D2 are reverse-biased and T1 is free to switch the video output between 30% supply voltage and full supply voltage

(figure 10). The video output must be fed to the aerial input of the TV via a video modulator such as that described in the Elektor TV Tennis article (Nov. '75).

The inverting amplifier of the block diagram is a 741 op-amp IC7, and the opto-isolator is at the bottom left of the circuit. In the absence of an input signal the output of IC7 is biased to about two-thirds supply voltage by R21 and R22. As the output of the alpha amplifier increases, then the input

voltage of the op-amp will rise as the opto-isolator transistor draws more current, and the output voltage of the op-amp will fall. As described earlier the input and (inverted) output voltages of IC7 are used to control the monostable pulse lengths and hence the size of the displayed rectangle.

A test input A is provided, which may be fed with a DC voltage or from a pot connected between point A and the positive supply rail, to check the functioning of the display generator. The operation of the display generator via the opto-isolator may be checked using the test circuit of figure 12, where a test signal is fed to the opto-isolator via a FET source-follower rather than from the output of the alpha amplifier. This circuit can also prove useful if it is desired to use the display generator for other applications than biofeedback. The 22 k potentiometer should be adjusted so that the voltage  $U_R$  across the 3k3 resistor is 1.5 V when the input of the circuit is shorted. Table 1 show the sort of results to be expected with this circuit.

For completeness' sake, a third input option is provided: B+. This input can be used if the display generator is to be driven from some other source than the alpha amplifier. Provision is made on the p.c. board for including a resistor  $R_S$  in series with the LED in the opto-coupler. The value of  $R_S$  will of course depend on the input level to be applied to this input.

## Construction

A printed circuit board and component layout for the alpha amplifier are given in figure 13, and for the display generator in figure 14. The following safety points should be noted:

1. The power supply to the alpha amplifier must be a 9 V battery, which must be connected only to the + and 0 terminals of the alpha amplifier.
2. The only connections between the alpha amplifier and display generator should be the B+ and B leads that join the output of the alpha amplifier to the opto-isolator input. There must be no connection between any part of the alpha amplifier circuit and the display circuit other than these connections.
3. The supply to the display generator may be stabilised mains power supply between 5 V and 15 V, or a separate 9 V battery may be used. **DO NOT USE A COMMON POWER SUPPLY FOR THE ALPHA AMPLIFIER AND DISPLAY GENERATOR.**
4. Care should be taken in the construction to ensure that no part of the display generator circuit or its power supply can contact any part of the alpha amplifier circuit, even in the event of a wire breaking. The simplest way to achieve this is to partition the box in which the unit is mounted, and place the alpha amplifier in one half and the display generator in the other half.

Figure 14. Printed circuit board and component layout for the display generator shown in figure 9 (EPS 9825-1).

Table 1. Measurement values for the video-feedback display with the add-on input circuit of figure 12.

Table 1		
$U_I$ peak-peak (mV)	$U_R$ peak-peak (mV)	horizontal picture width at 1 Hz
200	170	very small
300	240	
400	340	2...3% screen width
500	400	
600	480	
800	640	
1000	800	
1200	960	
1500	1200	20% screen width
2000	1700	
2500	2100	
3000	2400	
4000	3200	1/2 screen width
5000	4200	
6000	4400	3/4 screen width
7000	4700	
8000	5000	almost full screen
9000	5400	
10000	5600	out of screen

**WARNING:** As already pointed out in the text, it is essential that complete isolation is maintained between the alpha amplifier and the display generator. To this end the following points should be observed:

- The alpha amplifier must be battery-powered. It is potentially lethal to connect it to a mains power supply.
- The '0' of the alpha amplifier should not be connected to the '0' of the display generator. The only connection between these two units should be the opto-coupler.
- Contrary to what one might expect, the '0' of the alpha amplifier should not be 'earthed' either! To put it plainly, the only connections between the alpha amplifier and the 'outside world' are the electrodes at one end and the opto-coupler at the other.
- Although provision is made for mounting the opto-coupler on the p.c. board, extreme care should be taken at this point. Ideally, there should be absolutely no possibility of a leakage path between its input and output. To play it completely safe, the input pins can be bent up from the board and the input connections soldered direct to these pins; or, better still, the unit can be mounted 'off-board' between the alpha amplifier and display generator.

## Adjustment procedure

1. First adjust P1 on the alpha amplifier board until the output of A1 is at half supply voltage (4.5 V). Close S1.
2. Adjust potentiometer P1 and P2 on the display board until a stable picture is obtained.
3. With the input electrode grounded, adjust potentiometer P3 to P6 until a rectangle is obtained in the centre of the screen. It is important at this stage to ensure that the pulse lengths of the monostables are in the correct sense, otherwise the rectangle will decrease in size when an input is applied. The following points should thus be checked:
  - a. P3 sets the left boundary of the rectangle.
  - b. P4 sets the right boundary of the rectangle.
  - c. P5 sets the upper boundary of the rectangle.
  - d. P6 sets the lower boundary of the rectangle.

If the control of any of these pairs of boundaries is interchanged (e.g. P3 sets right and P4 left) then the corresponding pots must be readjusted until they are correct. The presets must then be adjusted until an extremely small rectangle is obtained.

The alpha amplifier can now be given a quick check by using it, not to pick up alpha rhythms, but heart activity. Holding an electrode in each hand a large rectangle should be obtained on the screen, whose size varies with the heartbeat.

The electrodes can now be connected to the head and attempts made to produce alpha rhythms, adjusting the sensitivity of the alpha amplifier as necessary by means of P2. ■

Have you got three hands?  
If so, the circuit on the inside  
of this month's mailing  
wrapper will be of little  
interest to you.



# magnetiser

During the second 'Bioclimatological Colloquium' which took place in September 1976 in Munich, a report was presented of a series of experiments carried out initially by Professor Dr. R. Mecke of the University of Freiburg and continued by several researchers of the University of Tübingen (Dr. W. Ehrmann, Dr. W. Ludwig et al.). 920 patients who complained of psychosomatic ailments were treated with a device which is the model for the 'magnetiser' described in this article. Of these 920 patients, 220 received a placebo, i.e. the device was a dummy. The complaints of the patients included insomnia and chronic headaches; since 1975 patients suffering from such ailments as migraine, neuralgia, extra-articular rheuma, damaged joints, neck and back pains, skin allergies, bronchial asthma, travel sickness and fear of heights have also been treated. It is significant that during the above experiment, the patients required approx. 50% less medication than normal. The overall results of the experiment (shown in table 1) are quite remarkable, particularly when one bears in mind that they are far better than the results obtained by the use of pharmaceuticals.

The figures given are all from a report released by W. Ehrmann, W. Ludwig, and their colleagues at Tübingen University. Our thanks go to Dr. Ludwig for his co-operation in the preparation of this article.

The device which is described in the remainder of the article, is of the same type as that used in the above experiment. It should be stressed that, although Elektor cannot offer any guarantees as to the efficacy of this treatment, the device is by no means to be considered in the same light as copper bracelets and old potatoes, but rather is a scientifically based approach which merits serious medical consideration.

## The effect of magnetic fields

The penetration of an alternating electromagnetic field is determined by its frequency. As long as the frequency is in the ELF (Extremely Low Frequency) range, the electric field can be ignored. The alternating magnetic field

Recent medical experiments have lent weight to the idea that magnetic fields are of therapeutic value in the treatment of psychosomatic complaints and rheumatic ailments.

The following article, which is preceded by details of a controlled experiment into the efficacy of this method of treatment, describes a device which will produce an alternating magnetic field of the type suitable for medical use.

on the other hand, will induce eddy currents throughout the entire organism, thereby causing shifts in the charge of the cell membranes. This stimulates the nervous system, removing any blockages which may exist.

For example, it was noticed that at frequencies below 8 Hz, a widening of the blood-vessels occurred, whilst at frequencies above 12 Hz the blood-vessels became narrower.

Experiments have also shown that the sensitivity of an individual to magnetic fields can be quite frequency-dependent. It is at a maximum at the frequency which coincides with the alpha-rhythm of that person's EEG. This is readily explicable in the light of the fact that externally induced pulses will obviously have the greatest effect upon pulses with which they are synchronous. Steep pulses which have a large number of harmonics produce better results than sinusoidal fields of similar amplitude. However the rise time need not be shorter than the response time of the tissue.

The therapeutic ELF-frequencies lie between approx. 0.5 Hz and 20 Hz, and can be subdivided into 4 treatment-specific groups:

- 1 ... 3 Hz, counteract infections;
- 4 ... 6 Hz, have a soothing effect, and counteract muscular spasm,
- 8 ... 11 Hz, act as an analgesic, as a tonic, and exert a stabilising influence;
- 13 ... 20 Hz, for patients who suffer from over-tiredness, these frequencies have the same effect as 8 ... 11 Hz have upon 'normal' patients.

The last group of frequencies is only used when lower frequencies have had no result. The 4 ... 6 Hz range should not be used whilst the patient is engaged in activities which require increased concentration (e.g. operating machinery, driving etc.).

Treatment with magnetic fields is not known to produce any side-effects, although persistent use may result in a lessening of its efficacy. It is therefore recommended that, for the time being, a treatment session should not last longer than 15 minutes. Patients with a heart pacemaker should not be treated with the lowest frequency range unless it is known for certain that it will not react to the magnetic field.

For normal use, i.e. when not applied to a localised area of pain, the magnetiser can be carried in a jacket pocket or waist pouch. If used when lying down, it can be placed under the neck or beneath a cushion or pillow.

## The circuit

Figure 1 shows the circuit diagram of the magnetiser. The circuit contains two astable multivibrators, one of which (N1/N2) oscillates at approx. 1.15 Hz, the other (N3/N4) at either 4.4 Hz, 9.7 Hz or 14.2 Hz, as selected by S1 ... S3 respectively. Some further



Table 1

No.	Number of patients/ devices	Frequency [Hz]	Field strength (max.)	symptoms	Success rate	
					No.	%
1	430 <sup>1</sup>	9-10	ca. 100 A/m	psychosomatic complaints	375	87%
2.	70 <sup>2</sup>	4-12	ca. 200 A/m	psychosomatic complaints and pains	63	90%
3	200 <sup>1</sup>	1-15	ca. 200 A/m	rheumatic pains	194	97%
4	160 <sup>2</sup>	10	--	psychosomatic complaints	33	21%
5	80 <sup>2</sup>	4-12	--	rheumatic pains	12	20%

1 = properly functioning device  
2 = dummy device

frequencies are obtained by closing more than one of the switches:

S1 + S2 = approx. 3.0 Hz,

S1 + S3 = approx. 3.4 Hz,

S2 + S3 = approx. 5.8 Hz;

S1 + S2 + S3 = approx. 2.5 Hz.

Transistor T1 is turned on and off in time with the chosen frequency. The pulsed collector current magnetises the core of coil L1, which consists of 600 turns of 0.2 mm diameter enamelled copper wire (38 SWG). In the Elektor lab a normal 'steel' bolt 40 mm long and 6 mm in diameter was used as the core. The coil may be scramble wound, i.e. the turns need not be wound in layers. The resultant field strength is comparable with that obtained from commercially available devices.

To prevent possible risks arising from a defect in the second AMV, it is recommended that in devices intended for use by patients with a heart pacemaker, components R1, R2, R5, C1 and C5 are not soldered onto the p.c.b., and that the free input of N1 be connected to the positive supply rail.

Figure 1. Circuit diagram of the magnetiser. The device requires only a small number of inexpensive components and is therefore cheap to build.

Figure 2. Copper side and component layout of the printed circuit board for the magnetiser (EPS 9827).

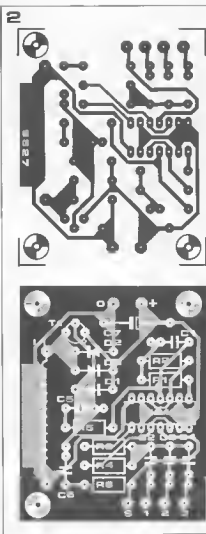

## Parts list:

## Resistors:

R1, R4 = 4M7  
R2 = 2M2  
R3 = 10 M  
R5, R6 = 4k7

## Semiconductors:

IC1 = 4011  
T1 = BC 557B, BC 177B  
D1, D2, D3 = 1N4148

## Capacitors:

C1 = 180 n  
C2 = 22 n  
C3 = 10 n  
C4 = 6n8  
C5, C6 = 15 n  
C7 = 47 μ/10 V

## Miscellaneous:

S1, S2, S3 = SPST switch  
L1 = see text

## Bibliography:

G. Altmann, (1969): *Die physiologische Wirkung elektrischer Felder auf Organismen.* Arch. Met. Geoph. Biokl. 17: 169-290.

S.M. Bawin, L.K. Kaczmarek, W.R. Adey (1975): *Effects of Modulated VHF Fields on the Central Nervous system.* ANN. New York Acad. Sci., USA, 247: 74-81.

D.E. Beucher, J.D. Grisser, R.E. Mitchell, (1973): *Exposure of Man to Magnetic Fields Alternating at Extremely Low Frequency.* NAMRL-1180.

Dokumenta Geigy (1968). 109-123  
W. Ehrmann, H. v. Leitner, W. Ludwig, M.A. Persinger, W. Sadtke, R. Thomas (1976). *Therapie mit ELF-Magnetfeldern.* Z. Phys. Med., 5: 161-170.

W. Ehrmann, H. v. Leitner, W. Ludwig, M.A. Persinger, W. Sadtke, R. Thomas (1976): *Entwicklung eines elektro-medizinischen Taschengertes.* Acta Medico-technica, 24: 282-285.

N. Geyer, G. Fischer, H. Riedl, H. Stampfer, (1976): *The effect of an Artificial Electroclimate on Physiological Values.* Arch. Met. Geoph. Biokl. Ser. B. 24: 111-112.

E.S. Maxey, (1975): *Critical Aspects of Human versus Terrestrial Electro-magnetic Symbiosis.* UNSC/URSI-IEEE Meeting, Boulder, Colorado, USA.

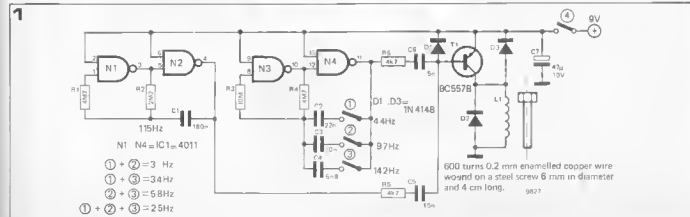

# slotless model car track 6

Because of the large amount of electronic circuitry that must be packed into the racing car, it is not possible to use the normal chassis as supplied with model car kits. As can be seen from figure 1, the servo alone would occupy a considerable proportion of the available space. In view of this fact it was decided to use a purpose-designed chassis which would also serve as a printed circuit board for the car power supplies, the circuit for which is shown in figure 2.

Power to the car is picked up from the track by contacts X1 to X4. Diodes D1 to D8 ensure that, whatever the orientation of the car on the track, a voltage of the correct polarity is always applied to the power supply circuits. Whilst the car is in motion contact with the track may frequently be intermittent, and it is vital that an uninterrupted supply should be maintained to the car electronics during these breaks of contact. For this reason large reservoir capacitors C2 and C7 are provided. These are charged through D9, D10, L1 and L2, and will maintain the supply to the receiver, decoder, servo amplifier and speed controller for about one second after the car loses contact with the track. However, since the drive motor consumes a large current it is not possible to maintain its supply in this manner. The motor supply is taken via L5, and if contact is lost the motor will stop and the car will slow down.

The 5 V supplies (U2 and U5) to the speed controller and servo amplifier are obtained using a 7805 IC voltage regulator, and the half supply voltage point for the servo amplifier (U1) is obtained from a voltage follower biased to half supply voltage, comprising a 741 (IC2) and transistors T1 and T2.

The 9.5 V supply for the receiver (U3) and the 5.6 V supply for the multiplex decoder are both provided by a discrete component stabilised supply Zener diode D11 is fed from a FET constant current source T3 to provide a 2.7 V reference. A portion of the output voltage is tapped off by the potential divider R5, R6, and is compared with the reference voltage in the differential amplifier U6, the output of which controls the series regulator transistor T4. The 5.6 V supply is

**This final article in the series on the slotless car track discusses the remaining electronic circuits, namely the power supplies for the car, track and infra-red transmitter, before describing the mechanical construction of the car and testing of the complete system.**

derived from the 9 V rail by a shunt regulator comprising R7, D12 and C15.

As is apparent from the circuit, the various supply rails are isolated from the input contacts and from each other by diodes, and are extensively filtered using chokes and capacitors. This is necessary because of the high sensitivity of the receiver and MPX decoder, the operation of which could be upset by interference pulses on the supply lines. The receiver must also be mounted as far as possible from the pickup contacts and motor, to avoid radiated r.f. interference caused by contact arcing.

The power supply circuits are accommodated on the printed circuit board shown in figure 3, which also forms the chassis of the racing car. The chassis shape must be cut out using a fret saw, and assembly of the p.c. board must be delayed until this has been done, as will be explained in the assembly instructions.

## Transmitter Power Supply

The power supply for the infra-red transmitter is shown in figure 4a. This is simply a stabilised supply based on an IC voltage regulator — a design which has previously been used in Elektor. A printed circuit board and component layout for the power supply are given in figure 4b; in this application diode D1, shown on the board, is not required and is replaced by a wire link.

## Track Power Supply

Power to the track is obtained from a simple, unregulated 15 V supply, the circuit of which is shown in figure 5. The current rating of the transformer should be about 1.5 A for each car that is to be used, and one 4700  $\mu$  reservoir capacitor should be added for each car. Thus if, say, four cars are to be run simultaneously, the transformer rating should be 6 A and the total capacitance should be about 18800  $\mu$ . Of course, it is not necessary to use individual 4700  $\mu$  capacitors if other values are to hand. For example, two 10000  $\mu$  or one 22000  $\mu$  capacitor(s) would be quite acceptable for a four-car power supply. Fuse F1 in the transformer primary circuit should be a slow-blow type, and



the current rating should be chosen to suit the power rating of the transformer:

$$I = \frac{P}{V}$$

where I is the fuse rating in amps, P is the transformer power in watts and V is the mains voltage in volts.

## Mechanical Construction

The first step in the mechanical construction is to cut out the chassis p.c.b. using a fret saw. Some of the car suspension and steering components are provided on the p.c. board, namely the two rear suspension mounts, which are to be found on the left of the board in figure 3, two control horns, which are on the right of the board, and the track rod, which is at the top of the board. These components should be cut out very carefully and should be worked to the correct shape using a file and emery paper.

## Front Suspension

The front suspension and steering mechanism of the car is the most critical part of the mechanical construction since, if it is not satisfactory the car will not perform well. The experienced model builder who has access to a lathe can easily construct a steering mechanism without assistance, but for the less experienced constructor the assembly must be easy to make using readily available parts and simple tools. Apart from simple handtools such as



Figure 1. Since a large number of components must be crammed into the racing car, the normal type of chassis supplied with model cars is too wasteful of space, as can be seen by comparison with the servo. A special chassis, which also doubles as a p.c. board, is therefore used.

Figure 2. Circuit of the car power supply, which are mounted on the p.c. board/chassis.

screwdrivers, spanners, centre punch, file and hacksaw, the only slightly less common tools required are an electric drill mounted in a vertical drill stand, a tap wrench and an M3 tap, or similar B.A. size (4 B.A. or 6 B.A. would do).

The suspension and steering system is based on readily available electronic hardware such as threaded hexagonal spacers and bits of alloy heatsinks. Figure 8a shows an exploded diagram of the complete front suspension system. The suspension bearers (12) and (23) are U sections cut from an aluminium heatsink. The suspension legs (4) and (20) are internal threaded hexagonal spacers, down the centre of which are lengths of threaded rod to act as pivots (5) and (28). Two control horns (15) and (19) joined by a track rod (16) operate the steering mechanism. The offside control horn is linked to the servo by a wire link (24).

Construction of the front suspension should begin by fabricating the suspension bearers and legs. The suspension bearers are made from U section heatsink in accordance with the dimensions given in figure 8b. A drill stand must be used when boring the holes to ensure that they are true and, to avoid bending the U section while drilling, it is best to cut the heatsink to length after the holes are drilled. To avoid the risk of injury the heatsink should be securely held in a vice or pliers while drilling - not in the fingers! After drilling and cutting to length the U sections should be deburred with a fine file.

2

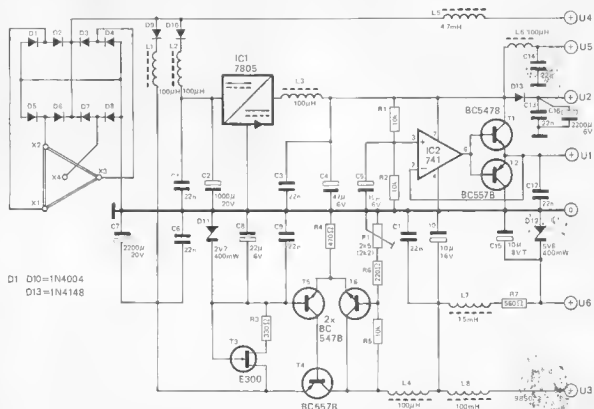

3

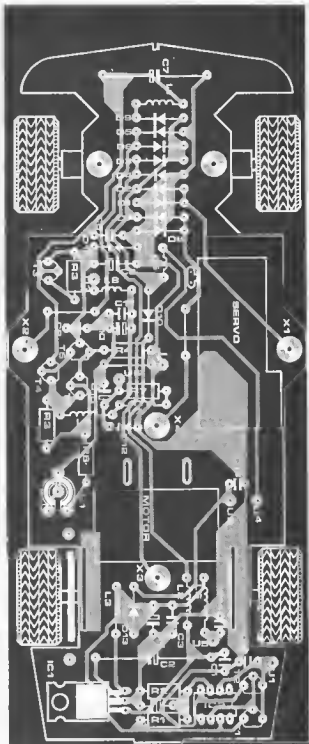
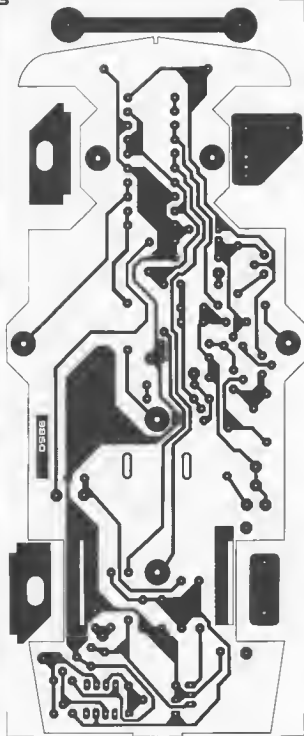

## Parts List to figures 2 and 3.

## Resistors:

R1, R2, R5 = 10 k  
 R3 = 330  $\Omega$   
 R4 = 470  $\Omega$   
 R6 = 220  $\Omega$   
 R7 = 560  $\Omega$   
 P1 = 2k5 (2k2) preset

## Capacitors:

C1, C3, C6, C9, C11, C12, C13, C14 = 22 n  
 ceramic disc  
 C2 = 1000  $\mu$ /20 V  
 C4 = 47  $\mu$ /6 V  
 C5 = 10  $\mu$ /6 V  
 C7 = 2200  $\mu$ /20 V  
 C8 = 22  $\mu$ /6 V  
 C10 = 10  $\mu$ /16 V  
 C15 = 10  $\mu$ /6 V tantalum  
 C16 = 2200  $\mu$ /6 V (not on board, see  
 also figure 12)

## Semiconductors:

T1, T5, T6 = BC547B  
 T2, T4 = BC557B  
 T3 = E300  
 IC1 = 7905  
 IC2 = 741  
 D1-D10 = 1N4004  
 D11 = 2V7/400 mW zener  
 D12 = 5V6/400 mW zener  
 D13 = 1N4148

## Inductors:

L1, L2, L3, L4, L6 = 100  $\mu$ H  
 L5 = 4.7 mH  
 L7 = 1.5 mH  
 L8 = 100 mH

4a

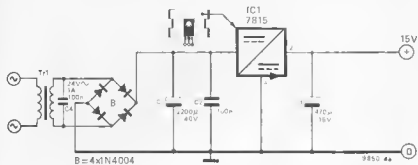

4b

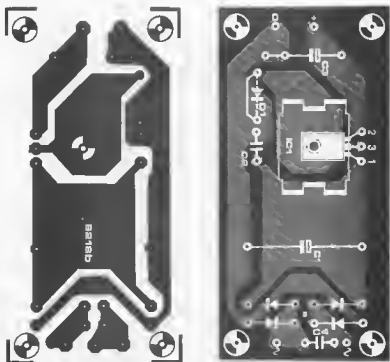

Parts list to figures 4a end 4b:

Capacitors:

C1 = 2200 µ/40 V

C2, C4 = 100 n

C3 = 470 µ/16 V

Semiconductors:

IC1 = 7815

B = 4 x 1N4004

Miscellaneous:

Transformer with 24 V/1 A secondary.

5

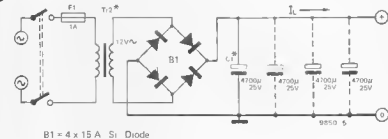

\* see text

Figure 3. The p.c. board/chassis and its component layout. Some of the steering and suspension components are also provided on this board, (EPS 9850).

Figure 4a. Stabilised power supply for the infra-red transmitter.

Figure 4b. Printed circuit board and component layout for the transmitter power supply. (EPS 9218)

Figure 5. Unstabilised power supply for the racetrack. An additional 4700 µ of reservoir capacitance is required for each additional racing car, and the transformer must be uprated by 1.5 A for each extra car.

Figure 6. Photograph of an early prototype of the racing car — which is somewhat of a lish-up!



Next, take a 10 mm long hexagonal spacer and check it for fit between the faces of the U section. If it is too long then file one end until it is a clearance fit. Repeat this with the other U section and another spacer. The hole for the stub axle must now be drilled and tapped in one face of the spacer. Mark the centre of one flat face of the spacer and dot with a centre punch. Drill a 2.5 mm hole right through the spacer and tap with a 3mm tap. Repeat with the other spacer. Finally, drill out the front wheel hubs to 3 mm, holding them in combination pliers as shown in figure 9, and cut two 28 mm lengths of 3 mm threaded brass rod.

Assembly of the front suspension may now commence. The nearside and offside suspension bearers are secured to the chassis using M3 nuts, bolts and lockwashers (8, 9, 10, 11 and similar for the offside). The suspension legs are then inserted between the faces of the bearers and are secured by threading the lengths of threaded rod through them. A plain washer and two nuts (6, 7, 21 and 22) are put onto the bottom of

7

Figure 7. Drive motors and rear axle sets similar to these can be obtained from most model shops.

Figure 8a. Exploded view of the front suspension and steering, which is built from readily obtainable components.

Figure 8b. Dimensions of the suspension bearers and suspension legs.

Figure 8c. The 'raw materials' used in the front suspension and steering assembly.

each rod and the nuts are locked together. M3 screws (1 and 25) are now passed through the wheel hubs into the threaded holes in the suspension legs and are tightened until they bite into the threaded rods running down the suspension legs, thus locking the suspension legs to the threaded rods. At this stage the wheel should be free to rotate and the suspension should be free to pivot.

A plain washer is now placed over the top of each threaded rod and an M3 nut (13 and 18) is run down lightly onto the washer. The control horns (15 and 19) are then placed over the rods and are locked in place by two nuts (14 and 17). Again check that the suspension is free to pivot and is not binding — if it is the nuts will have to be repositioned slightly.

The two control horns can now be linked by the track rod. Two ordinary p.c. terminal pins are pushed through the holes in the track rod and soldered. The pins are then pushed through the appropriate holes in the control horns and the track rod is secured by soldering a small washer to the head of each pin. At this stage the steering assembly should again be checked for freedom of movement.

The servo is now secured to the chassis using double-sided adhesive 'Servotape'. With the steering centred and the control horns of the servo central, the dimensions of the control link (24) can be measured up and the link bent from piano wire. The dimensions of the link will depend on the type of servo used and its exact position. The link can now be inserted into the holes in the servo and steering control horns and can be secured in a manner similar to that used to secure the track rod. In order to maintain correct steering geometry it is essential that when the servo control horns are central, the track rod is central and the roadwheels are in a straight ahead position. For this reason the wire control link must be made accurately. It is no good using a link which is the wrong length and trying to correct the resulting offset in the steering by adjusting the roadwheels, as this would spoil the steering geometry and cause poor cornering.

8a

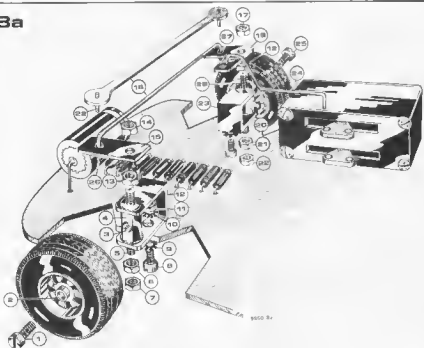

Key to Figure 8a

- |                               |                        |                                     |
|-------------------------------|------------------------|-------------------------------------|
| 1. Stub axle — M3 screw       | 9. Lockwasher.         | 19. Control horn.                   |
| 2. Nearside roadwheel.        | 10. Lockwasher.        | 20. Suspension leg.                 |
| 3. Tapped hole for stub axle. | 11. M3 nut             | 21. M3 nut                          |
| 4. Suspension leg             | 12. Suspension bearer. | 22. M3 nut.                         |
| 5. Threaded rod               | 13. M3 nut.            | 23. Suspension bearer.              |
| 6. M3 nut                     | 14. M3 nut.            | 24. Piano wire control link.        |
| 7. M3 nut.                    | 15. Control horn.      | 25. Stub axle — M3 screw.           |
| 8. M3 screw.                  | 16. Track rod          | 26. Track rod pivot — terminal pin. |
|                               | 17. M3 nut.            | 27. Track rod pivot — terminal pin. |
|                               | 18. M3 nut.            | 28. Threaded rod.                   |

8b

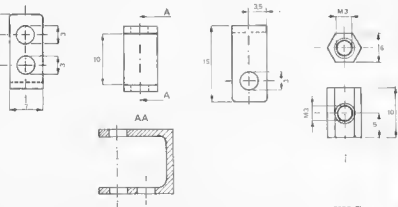

8c



9

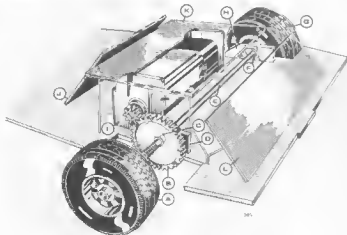

Figure 9. The wheel hubs should be held in combination pliers while drilling out the axle holes.

Figure 10. General layout of the rear suspension and drive unit, also showing the mounting of the multiplex decoder, speed controller and servo amplifier.

Figure 11. If a more powerful motor is used, which draws a current in excess of one amp, then T11 of the drive controller should be replaced by a BD 139 or BD 241B.

10



Key to figure 10.

- A. Nearside roadwheel.  
B. Axle gear.  
C. Axle bearing.

- D. Suspension mount.  
E. Axle.  
F. Axle bearing.  
G. Offside roadwheel.  
H. Suspension mount.

- I. Drive motor.  
J. MPX decoder board.  
K. Speed controller board.  
L. Servo amplifier board.

### Rear Suspension and Motor Gearing

Rear axle assemblies and drive motors for model cars are available from model shops (figure 7). Assembly of the rear suspension system is extremely simple. The two rear suspension mounts are soldered into the slots provided and a fillet of epoxy adhesive is added to give extra strength. The axle assembly is dismantled and the axle is passed through the holes in the suspension mounts.

The motor is then mounted on the chassis so that the motor pinion meshes with the axle gear, and the motor is then fixed in this position. Power can then be applied briefly to the motor to ensure that the roadwheels turn satisfactorily.

### Electrical Assembly

Once the basic mechanical assembly of the chassis is complete, the electrical components may be mounted in accordance with the component layout, after which power may be applied from

the 15 V track supply to any pair of the contacts X1 to X4 and the various supply voltages checked. P1 should be adjusted so that output U4 is 9.5 V.

The multiplex decoder, servo amplifier and speed controller may now be mounted. These three boards are arranged on the chassis around the motor, as shown in figure 10.

First, secure the speed controller to the top of the motor with a piece of 'Servotape' then, to provide more support, solder two stiff wire links between the spare holes provided in the left side of the chassis and the holes in the two left corners of the speed controller board. Solder in the motor suppression components, C16, and the supply connections U2 and U4 to the speed controller and motor.

Next, mount the servo amplifier (L) behind the motor, securing it by stiff wire links to the supply connections U1 and U5, and between the spare hole in the chassis and the corner hole of the servo amplifier board.

The last board to be mounted on the chassis is the MPX decoder board, which is mounted in front of the motor. The

11



infra-red receiver must be kept well away from sources of interference, so it is mounted inside the roof of the car body shell. The photodiode is mounted on top of the car roof and is wired to the receiver through holes drilled in the roof to accommodate the leads.

Once all the boards have been mounted in their respective positions they can be interwired in accordance with the wiring diagram of figure 12. Note that the link shown between the servo amplifier and the servo actually represents the five wires that join these two units. Wiring is probably best carried out using light-duty ribbon cable. Figures 14-16 show photographs of various stages of the construction

### Testing and adjustment

The principal adjustments to be made are tuning of the transmitter and receiver frequencies, and for this an oscilloscope is required. The adjustment procedure is as follows:

1. Temporarily disconnect the motor supply U4 (to avoid the car zooming away!) and connect the 15 V track supply to any pair of the contacts X1 to X4.
2. Switch on the IR transmitter and set its frequency adjustment preset P1 to the mid-position.
3. Half mesh the vanes of the receiver tuning capacitor C1, and place the car about 5 metres from the IR LED array.
4. Set the oscilloscope to 200 mV/div and monitor the receiver output. Adjust P1 on the transmitter board until the MPX signal at the receiver output has maximum amplitude and is noise-free.
5. Turn the IR LED array away from the receiver until noise again appears on the MPX signal, and readjust P1 for minimum noise.
6. Finally, adjust the receiver supply voltage U3 by means of P1 on the chassis p.c.b. for maximum amplitude of the MPX signal.
7. Once the optimum transmitter frequency has been found for the first car, the transmitter frequency should



12

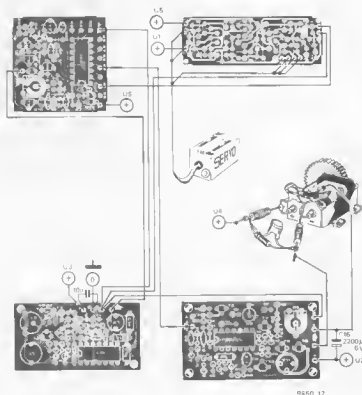

not be altered. To tune in other cars adjust the receiver trimmer C1 and adjust the receiver supply voltage as above.

### Final Remarks

Due to tolerances in the receiver input FET T1, it may be found that the receiver is insensitive. With the receiver supply voltage set to 9.5 V the drain voltage of T1 should be nominally 5 V. However, if the drain voltage is less than 4.5 V it will be necessary to increase the source resistor R4 to, say, 8k2. If the drain voltage is greater than 6.2 V then R4 should be reduced to, say, 5k6.

With more powerful types of motor that draw currents much greater than one amp, it will be necessary to replace T11 on the motor speed controller with a BD 139 or BD 241B. However, since it should not be necessary to fit a heatsink to these types of transistor they take up little extra space on the board, as can be seen from figure 11.

In some cases it has been found that the input impedance of the servo amplifier is too low to be driven by the MPX decoder, and that the threshold voltage is in excess of 2.5 V. A useful modification therefore, is to change the components of the servo amplifier input attenuator to R1 = 47 k and R2 = 150 k.

13

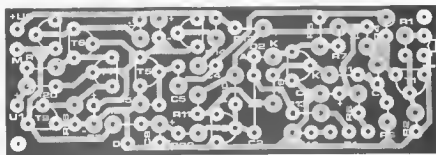

Figure 12. Interconnection diagram for the car electronics.

Figure 13. The component layout of the servo amplifier given in part 3 (fig. 13) was unfortunately not very clear, so it is here reproduced twice full size.

Figures 14 to 16. Showing various stages in the construction of the racing car. Note that this is the 'Mk. II' prototype, which differs in some slight details from the final version.

14



15



16

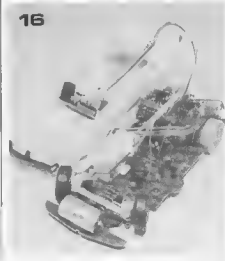

# formant

## the elektor music synthesiser (5)

Care must be taken in the choice of components for, and in the construction of, the VCO, if reliable performance is to be obtained. The same general comments apply that were made earlier with regard to component quality. In addition, the following points should be noted:

1. Capacitor C2 should be a low leakage type — preferably MKM or equivalent.
2. Transistor T1 to T3 should be tested, as will be explained later.
3. Diodes D3 and D4 should be a matched pair.

It is important that the reset transistor T1 in the CCO section should be selected for low leakage current, as excessive leakage current means current lost from C2 and non-linearity of the CCO at low frequencies.

The test setup for T1 is shown in figure 1. The PNP transistor T8 can be used as the second transistor in the circuit, or any similar transistor can be used. The meter can be a multimeter set to the 1 mA range. The base of T8 is initially left open-circuit to check that it is not leaky. The meter should read zero. The base of T8 is then connected to the 0 V rail via a 100 k resistor to check that it has adequate current gain. The meter should read at least 1 mA (i.e. full-scale). The base of T8 is then connected to the collector of T1. Any leakage current through T1 will be amplified by the current gain of T8 to give a deflection on the meter. Only if the meter reads zero is the leakage current of T1 sufficiently low.

Finally, the current gain of T1 can be checked by connecting its base to +5 V through a 2k $\Omega$  resistor, when the meter should again show full-scale deflection.

FETs T2 and T3 can be tested using the circuit given in part 3 for testing the FETs in the keyboard interface. Unlike the keyboard interface circuit, FETs which show a  $U_S$  in the test circuit of less than 0.5 V are not suitable for the VCO. However, FETs that have been rejected for the keyboard interface because their  $U_S$  value was too high, can be used in the VCO if the value of  $U_S$  lies between 1.6 V and 2 V. For FETs with  $U_S$  values between 0.5 and 1.5 V the source resistors R17 and R20 should

be selected from table 1 in part 3. For FETs having a  $U_S$  value between 1.6 V and 2 V, R17 and R20 should be 4k7. Diodes D3 and D4 should be purchased as a matched pair or, if several diodes of the correct type are to hand, a reasonably matched pair may be selected by measuring the forward voltage drop versus forward current characteristics of the diodes and selecting the pair that are most similar.

**Construction**

Once these critical components have been selected, construction of the VCO may commence. On the printed circuit board the VCO is split into two functional sections, the exponential converter and CCO, the complete circuit of which is given in figure 2a, and the curve shaper section, the complete circuit of which is given in figure 2b. These two circuits are the combination of all the partial circuits discussed last month.

Printed circuit board and component layouts for the VCO are given in figure 4. The oscillator section occupies the top third of the board, whilst the remainder of the board contains the curve shaper circuits. To avoid interaction between the two sections of the circuit they each have separate supply and ground connections. The only link between them is at the source of T3, which is the CCO output (point A in figures 2a and 2b). Assembly of the board poses no particular problems, the only point to note being that at this stage C13, R26, R27, R42, R43, R54, and the link joining pin 4 of IC3 to the gate of T2, are omitted for test purposes.

(C. Chapman)



be selected from table 1 in part 3. For FETs having a  $U_S$  value between 1.6 V and 2 V, R17 and R20 should be 4k7. Diodes D3 and D4 should be purchased as a matched pair or, if several diodes of the correct type are to hand, a reasonably matched pair may be selected by measuring the forward voltage drop versus forward current characteristics of the diodes and selecting the pair that are most similar.

### Construction

Once these critical components have been selected, construction of the VCO may commence. On the printed circuit board the VCO is split into two functional sections, the exponential converter and CCO, the complete circuit of which is given in figure 2a, and the curve shaper section, the complete circuit of which is given in figure 2b. These two circuits are the combination of all the partial circuits discussed last month.

Printed circuit board and component layouts for the VCO are given in figure 4. The oscillator section occupies the top third of the board, whilst the remainder of the board contains the curve shaper circuits. To avoid interaction between the two sections of the circuit they each have separate supply and ground connections. The only link between them is at the source of T3, which is the CCO output (point A in figures 2a and 2b). Assembly of the board poses no particular problems, the only point to note being that at this stage C13, R26, R27, R42, R43, R54, and the link joining pin 4 of IC3 to the gate of T2, are omitted for test purposes.

### Test and adjustment

The first test is to check that the CCO is functioning, and for this purpose a 1 M resistor is connected between the gate of T2 and -15 V to act as a current source for the CCO. The CCO output can be monitored with an oscilloscope at point A.

Should the oscillator fail to start then P10 can be adjusted until it does. It will probably be found that the oscillator stops as the slider of P10 approaches its two extreme positions, and P10 should

be set midway between the positions at which oscillation ceases. At this stage, the frequency of the oscillator should be around 1 kHz, and the waveform will not be a perfect sawtooth, but will exhibit an exponential curvature due to the 1 M resistor being used in place of a constant current source.

Once the CCO has been checked the 1 M resistor can be removed and the CCO connected to the exponential converter by soldering in the link between pin 4 of IC3 and the gate of T2.

With the sliders of P2, P3 and P8 turned to zero volts and the KOV input grounded, it should now be possible to vary the VCO frequency by adjusting P1. If the exponential converter is operating

correctly the waveform at point A should be a perfect sawtooth. It may be found that at low frequencies the VCO will not oscillate reliably, in which case the adjustment of P10 will require further attention.

Once the VCO functions reliably over the entire audible range, P1 should be turned completely anticlockwise and the offset potentiometer P8 adjusted until the lower frequency limit (with no control voltage other than from P8) is around 15 Hz. This adjustment does not need to be extremely accurate.

### Curve shaper section

Adjustment of the curve shaper begins with the spaced sawtooth converter section. P11 adjusts the clamp level of

Figure 1. Simple test circuit for selecting transistor T1 of the VCO.

Figures 2a and 2b. These two circuits constitute the complete VCO, and combine into two functional groups the partial circuits discussed last month.

1

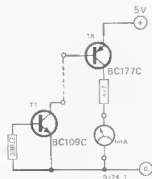

2a

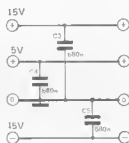

IC1 = 7413

IC2, IC4 =  $\mu$ A741 C, MC1741 CP1 (MINI DIP)IC3 =  $\mu$ A726 C (TO)

T1 = BC109 C

T2, T3 = 8F245 AB

D1, D2 = 1N4148, 1N914

\* see text

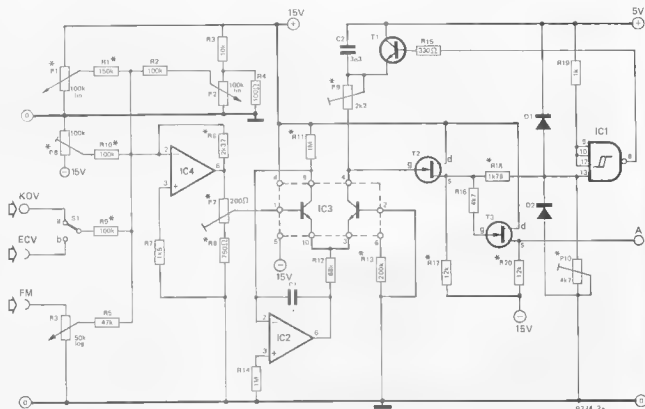

this circuit and hence the 'spikiness' of the waveform, which affects the tonal quality. The adjustment is a matter of taste, but as a guideline the peak-to-peak amplitude of the waveform, viewed at point S3a, should be about 3 V.

Next, the triangle converter (T4, T5) can be adjusted. The symmetry of the triangle waveform is determined by the matching of diodes D3 and D4. P12 can compensate for slight mismatches in these diodes, but if the degree of mismatch is large the only answer is a better matched pair of diodes. The output waveform should be monitored at point S5a with P12 in its mid-position, and P12 should then be turned one way or the other to obtain a sym-

metrical triangular waveform. If notches are apparent at the peaks of the triangle waveform (especially noticeable at high frequencies) then capacitor C13 should be added. The value of 1 n is given as a guideline, but C13 should preferably be chosen experimentally to give the best compromise between elimination of the notches and attenuation of the signal at high frequencies.

Once the triangle waveform is satisfactory the sine converter may be adjusted. Ideally, diodes D5 and D6 should also be a matched pair in order to ensure symmetry of the sine waveform. However, a random pair of 1N4148s or 1N914s will usually prove to be a sufficiently close match in practice. The purity of the sinewave is adjusted

visually by monitoring the waveform at point S6a and varying the resistance of P13 for best results. The sine converter output can be compared with the sine output of a signal generator, if available, or with a sine curve plotted on graph paper. The purists may like to adjust for minimum distortion using a distortion meter, though the simpler adjustment procedure is adequate from a musical point of view.

The final section of the circuit to be adjusted is the pulse-width modulated squarewave generator. The aim of this adjustment is to set trimmers P14 and P15 so that the adjustment range of P5 varies the duty-cycle from 1% to 99%. The setting-up procedure is as follows:

2b

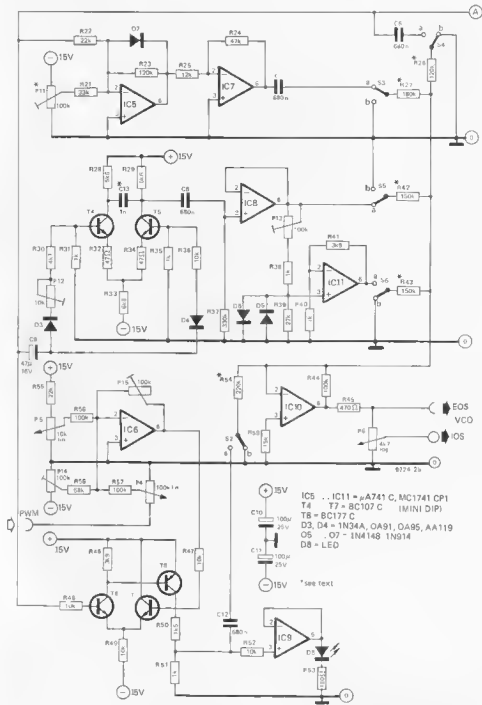

- 1) Adjust P14 until its wiper voltage is  $-5.5\text{ V}$ , and adjust P15 to maximum resistance.
- 2) Connect the voltmeter to the output of IC6 and monitor the PWM signal at point S2a with an oscilloscope.
- 3) Adjust P5 to give first maximum (approx. 99%) and then minimum pulse width (approx. 1%) of the PWM signal, and note the output voltage of IC6 for these two conditions thus:  $-V_{\text{max}}$  = voltage for minimum pulse width,  $V_{\text{min}}$  = voltage for maximum pulse width.
- 4) Turn the wiper of P14 to zero volts and the wiper of P5 to maximum voltage. Now used P15 to adjust the output voltage of IC6 so that it is equal to the difference between the two previously noted values  $V_{\text{max}}$  and  $V_{\text{min}}$  i.e.  $V_0, \text{IC6} = V_{\text{min}} - V_{\text{max}}$ . The output voltage of IC6 will be negative since it is connected as an inverting amplifier.
- 5) Adjust P14 to give maximum pulse-width (99% duty-cycle) of the output signal. When the wiper of P5 is now turned to zero volts the pulse width should be minimum (1% duty-cycle). This completes the adjustment of the PWM stage.

Oscillograms of all the waveforms are shown in photos 1 to 7.

#### Output adder

Once the various sections of the curve shaper have been adjusted the input resistors of the output adder may be selected (R26, R27, R42, R43 and R54). A 250 k potentiometer is connected in place of each resistor in turn, and the peak-to-peak amplitude of the relevant waveform is adjusted to about 2.5 V at output EOS. The resistance of the pot is then measured and it is replaced by a fixed resistor of the nearest preferred value from the E24 range.

#### Front panel

A front panel layout for the VCO is given in figure 3. The three inputs, FM, ECV and PWM are at the top of the panel, with the switch (S1) to select between ECV and KOV mounted below. Potentiometer P3, which controls the FM modulation depth, is mounted below the FM input socket, while P4 and P5, which control the pulse width modulation depth and duty-cycle respectively, are mounted below the PWM input socket. The coarse and fine tuning controls (P1 and P2) are also grouped together, on the left of the panel, while the output level control (P6) is grouped with the waveform selection switches (S2 to S6) and the output socket.

#### Module construction

It is essential that the VCO module should be screened to avoid any interference pickup. To provide this screening, and to make the module

3

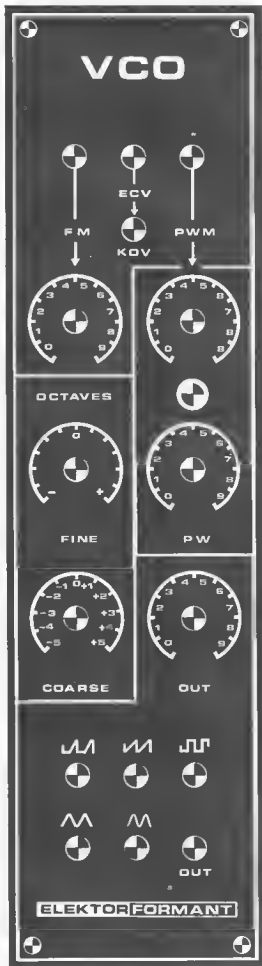



ECV	= External Control Voltage, i.e. front-panel input to VCO.
KOV	= Keyboard Output Voltage, i.e. permanently wired input to VCO from interface receiver.
FM	= Frequency Modulation Input
PWM	= Pulse Width Modulation input
EOS	= External Output Signal from VCO (front panel output)
VCO/IOS	= Internal Output Signal from VCO, will be permanently wired to one VCF input.

Figure 3. Suggested front panel layout for the VCO.

Photos 1 to 7. These oscillograms give an indication of the waveforms that should be available at the curve shaper outputs:

1. Sawtooth
2. Spaced sawtooth
3. Triangle
4. Sinewave
5. Squarewave, minimum duty-cycle
6. Squarewave, 50% duty-cycle
7. Squarewave, maximum duty-cycle.

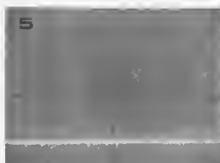
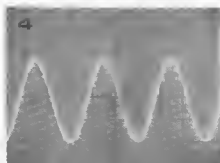

mechanically rigid, the p.c. board is mounted on a carrier made from 16 or 18 SWG aluminium. The dimensions of the carrier are those of a large Eurocard (165 mm x 210 mm) so that the module will fit a Euro-standard card frame. A right-angle bend at the front edge of the carrier allows it to be secured to the front panel by means of the potentiometer mounting bushes. The p.c. board is mounted on the carrier using M3 screws and spacers. Photo 8 shows the completed module.

### Octaves/Volt adjustment

The most critical adjustment made to the entire synthesiser is the setting up of the octaves/volt characteristic of the VCOs, as this adjustment determines the accuracy of the synthesiser tuning.

There are two methods of adjusting the VCO. The simpler method requires the use of a frequency counter and digital voltmeter, while the second method requires an audio signal generator with a calibrated frequency scale.

Before commencing the adjustment procedure power should be applied to the VCO for several minutes to allow the temperature (especially of IC3) to stabilise.

To adjust the VCO using frequency counter and DVM, all inputs and controls of the VCO input adder are set to zero volts and P9 is set in its centre position. The frequency counter is connected to the VCO output and the DVM to the wiper of P1. With P1 turned fully anticlockwise the frequency counter will read around 15 Hz, which was set previously by means of P8. P1 is now turned slowly clockwise until the DVM reads 1 V, when the VCO frequency should be twice what it was with P1 set to zero, e.g. if the zero frequency was exactly 15 Hz the frequency should now be exactly 30 Hz. Of course, initially this will not be the case, and some adjustment of P7 will be required. P1 is then turned until its wiper voltage is exactly 2 V, when the VCO frequency should be four times the zero voltage frequency, e.g. 60 Hz. This procedure is repeated at 1 V steps over the entire range of P1, checking that the correct frequency is obtained at each step. Thus if 0 V = 15 Hz, then 1 V = 30 Hz, 2 V = 60 Hz, 3 V = 120 Hz etc. P7 is adjusted to obtain the best accuracy possible over the widest frequency range. At high frequencies (greater than 3 kHz) P9 can be used to correct any deviations from the 1 octave/volt characteristic.

To adjust the VCO using the beat note method, the outputs of an audio oscillator and the VCO must be fed into the left- and right-channels of a stereo amplifier, or via an audio mixer into a mono amplifier, so that the beat notes can be heard via the loudspeakers. The VCO is connected to the KOV output of the previously calibrated keyboard.

The audio oscillator is set to a frequency between 400 and 500 Hz, and the main tuning of the keyboard is switched off.

4

9723-1

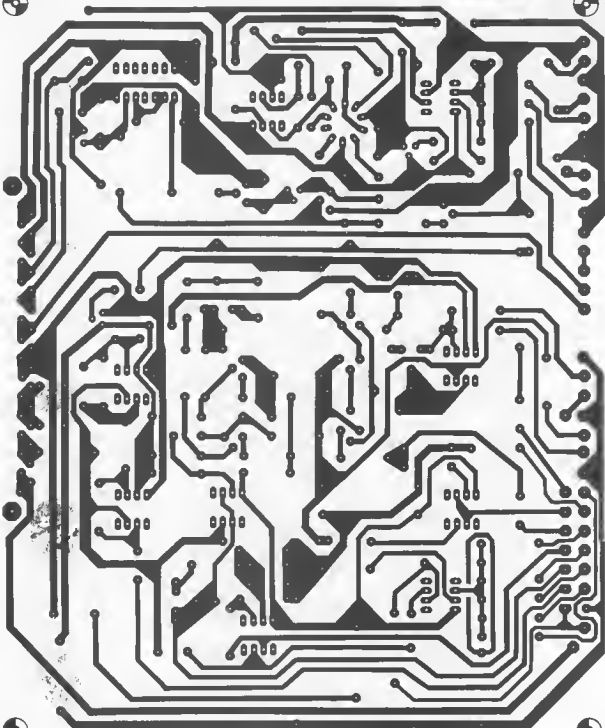

#### Parts list for figures 2 and 4.

##### Resistors:

a. 1% metal oxide  
 R1 = 150 k  
 R6 = 2k37<sup>1</sup>  
 R8 = 750 Ω  
 R9, R10 = 100 k  
 R11 = 1 M  
 R13 = 200 k  
 R18 = 1k78<sup>1</sup>

<sup>1</sup> These are 'optimum' values. However, 2k4 and 1k8 resistors can be used

for R6 and R18 respectively, provided they are 1% metal oxide types!

b. 5% carbon film  
 R2, R44, R56, R57 = 100 k  
 R3, R36, R47, R48, R49, R52 = 10 k  
 R4 = 100 Ω  
 R5, R24 = 47 k  
 R7, R50 = 1k5  
 R12, R58 = 68 k  
 R14 = 1 M  
 R15 = 330 Ω  
 R16, R30 = 4k7  
 R17, R20 = 12 k (nominal)

R19, R31, R35, R38, R40, R51 = 1 k  
 R21 = 33 k  
 R22, R39, R55 = 22 k  
 R23 = 120 k  
 R25 = 12 k  
 R26 = 120 k (nominal)  
 R27 = 180 k (nominal)  
 R28, R29 = 5k6  
 R32, R34 = 47 Ω  
 R33 = 6k8  
 R37 = 330 k  
 R41, R46 = 3k9  
 R42, R43 = 150 k (nominal)  
 R45 = 470 Ω

R53 = 180 Ω  
 R54 = 220 k (nominal)  
 R59 = 15 k

##### Presets:

a. Cermet  
 P7 = 200 Ω (or 220 Ω or 250 Ω) multiturn preset.

Note pinout, end pins spaced 5.1 mm and 7.6 mm from centre pin, which is offset by 2.5 mm.  
 P8, P11 = 100 k  
 P9 = 2k2  
 P10 = 4k7

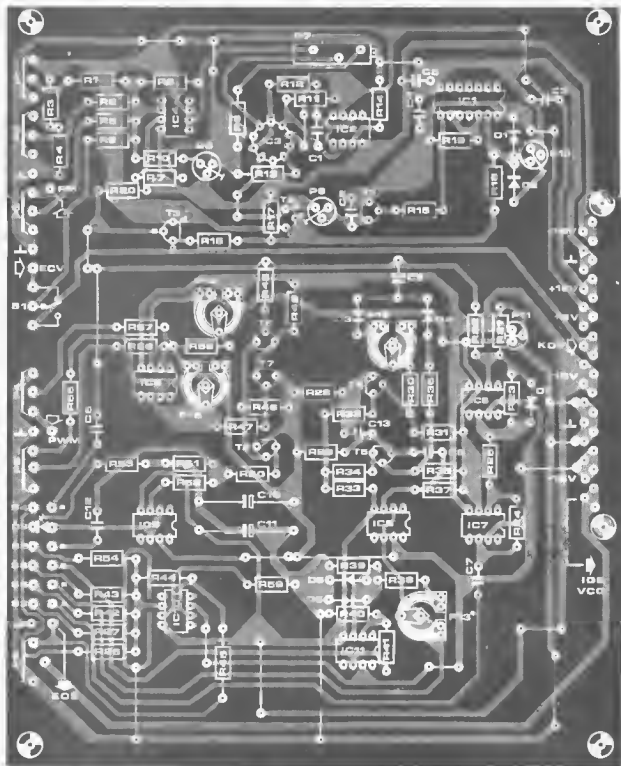

b. Carbon  
P12 = 10 k  
P13, P14, P15 = 100 k

Potentiometers:  
a. Cermet  
P1 = 100 k lin

b. Carbon  
P2, P4 = 100 k lin  
P3 = 50 k log.  
P5 = 10 k lin.  
P6 = 4k7 (5 k) log.  
Capacitors:  
C1 = 1 n

C2 = 3n3 (MKM)  
C3, C4, C5, C6, C7,  
C8, C12 = 680 n  
C9 = 47  $\mu$ /16 V  
C10/C11 = 100  $\mu$ /25 V  
C13 = 1 n (see text)

Semiconductors:  
T1 = BC109C  
T2, T3 = 8F245A, B  
T4... T7 = BC107C  
T8 = BC177C  
D3, D4 = DA91, DA95,  
AA118, AA119, or 1N34A

D1, D2, D5,  
D6, D7 = 1N4148, or  
1N914  
D8 = LED, TIL209 or  
similar  
IC1 = 7413  
IC2, IC4, IC5, IC6, IC7, IC8,  
IC9, IC10, IC11 =  $\mu$ A 741C  
or MC1741 CP1  
(MINI DIP)  
IC3 =  $\mu$ A 726C (Fairchild,  
TD package)

Miscellaneous:  
31 pin (DIN 41617)  
connector  
S1... S6 = SPDT  
miniature toggle switch,  
4 x 3.5 mm jack sockets

Figure 4. Printed circuit board and component layout for the Formant VCO (EPS 9723-1).



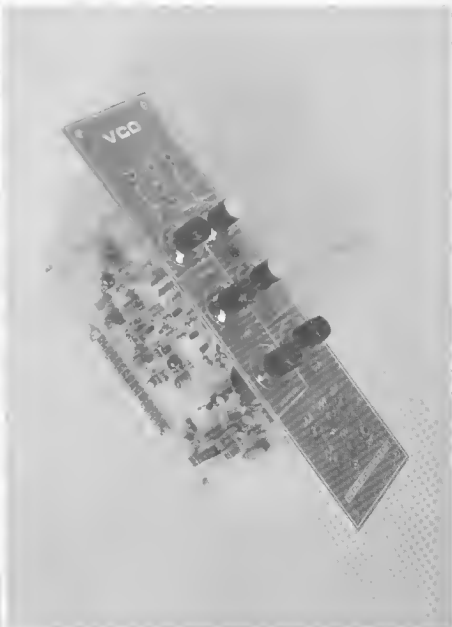
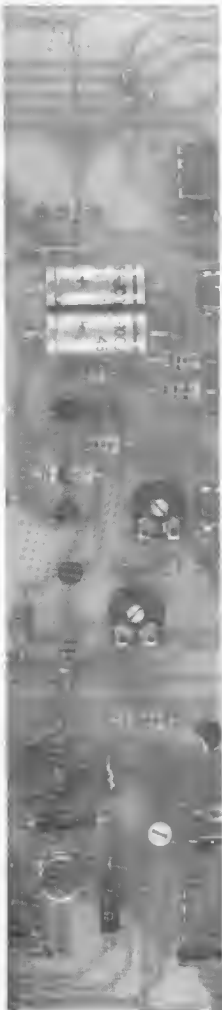

Photo 8. The completed VCO module.

The top note of the keyboard is then depressed, and the VCO tuning controls P1 and P2 are adjusted until the audio oscillator and VCO are in tune with zero beat.

Next, the key an octave lower is depressed, when a dissonance or very rapid beat note will be heard. P7 is then adjusted until zero beat is obtained between the audio oscillator and the VCO note one octave lower.

The top key is again depressed, when it will be found that, due to the adjustment of P7, a beat note is again heard. Using the VCO tuning controls, readjust for zero beat, then depress the key an octave lower, which will now be slightly out of tune due to adjusting the VCO tuning controls. P7 must therefore be readjusted to obtain a zero beat.

This procedure is repeated several times until the oscillator is perfectly in tune with both the top note and the note an octave lower. The tuning is then checked two octaves and three octaves below top C, and if necessary P7 is readjusted to obtain the best tuning over the entire keyboard range.

The higher ranges of the VCO must now be adjusted using P9. For this purpose the audio oscillator is tuned to around 2 kHz, the bottom note of the keyboard is depressed, and the coarse and fine tuning controls of the VCO are adjusted for zero beat. The key an octave higher is then depressed, and P9 is adjusted for zero beat using the same technique as for the previous adjustment procedure using P7. The tuning is then checked two octaves and three octaves above bottom C.

This completes the adjustment of the VCO. Next month's article will describe the circuit of the voltage-controlled filter (VCF). This is an exponential voltage controlled, multimode filter with four functions and variable Q-factor. ■

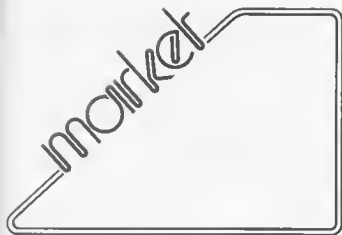

## Microprocessor 'Hands-on' development system

Designed around the National Semiconductor SC/MP, eight-bit microprocessor, this development system - SCRUMPI - which has been designed and developed by Bywood Electronics Ltd., provides a self-contained low-cost system for the engineer or student who wishes to obtain 'hands-on' experience of using and designing with microprocessors. Mounted on a single printed-circuit board, the system costs only £55 which, it is claimed, is more than price-competitive with any other similar system.

### Microprocessor addressing

In 'Scrumpi', the states of the 12 address lines and the eight data lines are displayed in binary form on light-emitting diodes driven by C.M.O.S. buffers. The data lines can be taken to ground by eight programming switches. The memory consists of two 256 x 4 bit memory chips, providing 256 words of read/write memory. Two four-bit latches act as an eight-bit I/O port in which each set of four can be wired as either inputs or outputs. The various functions of the kit are controlled by a flip/flop, a 555 timer and NAND gates, which are selected by eight toggle switches: RESET; SLOW; STEP; RUN/HALT; PROTECT; SENSE-A; SENSE-B; and LOAD.

Scrumpi is programmed by stepping or running the microprocessor to the required address, putting the eight data switches to the required eight-bit binary value, and then operating the load switch. This switch puts the memory chips into read mode and so loads the value on the data bus into the memory location. All parts are supplied in the kit including sockets for all ICs. The switches are soldered to the board by their terminals. The circuit needs a power supply of +5 and -7 volts and these can be derived from a single 12 volt supply with a five volt Zener diode. Comprehensive instructions and operating data are provided with

Scrumpi along with operating details for the SC/MP microprocessor.

*Bywood Electronics Ltd.,  
68 Ebbw Road,  
Hemel Hempstead, Herts,  
HP3 9QR, England*

(571 M)

## 8085 Design kit

Intel have just announced a new design kit based on their recently announced 8-bit microcomputer, the 8085. Known as the SDK-85, the prime purpose of the kit is to provide a means for engineers to evaluate and become familiar with the 8085 microcomputer. It is also very useful for building prototype systems and for one-off applications. Since the SDK-85 is a complete system incorporating on-card 24-key keyboard input and a 6-digit 7 segment LED display output, it will also be popular with computer experimenters and hobbyists.

The kit (see block diagram) contains a 1.3  $\mu$ sec cycle time 8085 cpu; an 8355 providing 2 K bytes of program memory (containing the system monitor) and two programmable I/O ports; and an 8155 which, in addition to providing 256 bytes of read/write memory, also adds a pro-

grammable 14-bit timer and a further two programmable I/O ports. A new chip, 8279, is used in conjunction with two 8205 1 of 8 decoders to provide direct interface to the on-card keyboard and display.

As supplied, therefore, the SDK-85 has 2 K bytes of PROM, 256 bytes of program memory and no fewer than 38 general-purpose TTL level parallel I/O lines. A serial port is implemented using the SID and SOD lines of the 8085 with software generated timing. This is set for 20 mA current loop and I/O baud enabling direct connection to a standard teletype, although the system can be operated without a teletype.

The SDK-85 has been designed with user expansion in mind; not only has a large (45 sq.in.) wire wrap area been provided, but the circuit provides for a number of additional chips if required. An extra 8155 and 8355 can be added to double the on-card program memory, read/write memory and parallel I/O capability. There is also space for 8212 and 8216 bus drivers, should it become necessary to provide off-card bus driving capability.

The keyboard has 16 hexadecimal keys, four of which serve a dual purpose, and eight special-function keys such as vectored interrupt, single-step, go, substitute memory and examine memory. The on-card monitor provides a number of general-purpose utilities and supports the keyboard/LED I/O in addition to a teletypewriter, using standard Intel monitor commands.

*INTEL Corporation (UK) Ltd.,  
4 Between Towns Road, Cowley,  
Oxford OX4 3NB, England*

(572 M)

## Versatile data cassette terminal

The Model MFE 5000 cassette terminal, which is now available from Data Dynamics, is manufactured in America by the MFE Corporation of

New Hampshire. It is an extremely reliable unit that has been designed to fit into a wide variety of data processing and data capture systems.

As with any system employing a combination of electronic and mechanical components, it is usually the mechanical side that is the most prone to failure. To combat this, and to ensure that the MFE 5000 performs reliably in the field, a tried and tested tape transport system has been used. This is the Model MFE 250b, of which more than 20,000 units have been sold worldwide. Much of the reliability of the tape transport mechanism is due to the complete absence of any pulleys or belt drives.

The internal microprocessor controls the cassette transport and implements all commands to the system. In addition to forcing the operator to perform only legal operational sequences, it also implements all the internal self-checking such as parity, read-after-write and cyclic redundancy check (CRC).

The Model 5000 can be switched for either an 86 or 138 character block length and is totally ANSI and ECMA compatible.

Interface to the system can either be CCITT V24 (EIA RS-232C) or TTY current loop, so that the unit can either function as a terminal replacement or can be connected directly to a terminal for off-line data preparation. Communications rate is switch selectable to any one of six speeds from 110 to 2400 baud. Character length is 11 bits at 110 baud and 10 bits at all other speeds.

Transmission can be either half or full duplex and is asynchronous serial bit-by-bit character. Each 300 ft. long cassette will store up to 221,000 characters which are recorded at 800 bits per inch using a single track and phase encoding to ANSI/ECMA specifications.

Operator controls are provided for read, write, initialize, fast forward, rewind, auto-program search and edit. There are also thirteen remote control functions which are implemented by ASCII control characters; these are: start and stop read, start and stop write, erase, rewind, load point, search, status, skip, backspace, reset and cancel. There are many other functions that can also be implemented if desired. Other features in the comprehensive specification for this unit include adjustable carriage return delay, automatic source control, binary data read, and front panel indicators for ready, busy, end of tape and 'data' (illuminates when data is either being sent or received).

*Data Dynamics Ltd., Data House,  
Springfield Road, Hayes,  
Middlesex, England*

(573 M)

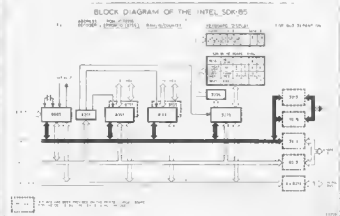



TYPE 7252  
TMD 81 N

**EURO FM-UKW TUNERMODULE**

SIGNALMASTER MARK 8 \*)

AUDIO HI FI MASTER 2x30 W \*)

\*) KITE BAUSATZE

**LARSHOLT ELECTRONICS A/S**

DK 4622 - HAVDRUP - DENMARK

**GB** AMBIT INTERNATIONAL TEL: (0277) 21 8029  
2 Greenhill Road, Brentwood Essex

**DE** CORAM ELECTRONICS LTD TEL: (0532) 4024-41  
PO Box 178 L880G L59 1UF

**NE** HOLLAND ELECTRONICS TEL: (071) 180891  
Boschparkweg 28 L818BN 2465

**DD** KLAUS-PETER MENNICKEN TEL: 04321 48983  
Gartenstraße 10 2280 NEUMÜNSTER

**F** S I R P M BRUNET & CIE TEL: (011) 4446378  
18 rue de Douai 92011X

**SCANDINAVIA**

We do not have to advertise elekta because you already know it. What you do not know is that you can order all elekta products without ordering and exchange problems. We have all back issues and most p.c. boards in stock. In case a p.c. board is not in stock the delivery takes about four weeks and there are no extra costs. Surely you can also subscribe to elekta through us. As we deal only with elekta products we offer you a quick service at low prices (please compare with other dealers) and we send the ordered items without postage.

P.c. board prices are mentioned according to the price lists in the back issue of elekta, we count twelve orders for every pound (£) (includes v.a.). Single orders subject to cost.

And we charge for  
Subscription 1876 per 30 —  
Basic issue per 7,50 (Summer issues 12 —)  
Work 78 per 40 —

Please fill in the elekta order form and send it to

**COILTRONIC**

Coiltronic, Box 5007, S-180 28 Svanås, Sweden  
Tel: 087823845

Minimum orders per 30 —

**Greenway Electronic Components**

Low Cost Import Ltd

52 Maypole Rd, Ashurst Wood  
East Grinstead, Sx RH19 3R4  
Tel: 0436 78461 (STD 034 287) 33 37

**Electrolytic Capacitors\***

RADIAL Case Size & Voltage	AXIAL Capacitance & Voltage	Errors
81 50 08 81 100 01		
1 50 08 84 1 100 01		
1.7 50 08 84 2 1 100 01		
2.2 50 08 84 3 1 100 01		
1.1 1 50 08 10 28 01		
1.1 50 08 10 51 01		
35 40 08 30 490 08		
10 70 08 34 22 28 01		
35 50 08 34 83 10 01		
22 10 08 44 00 10 10		
22 28 08 44 15 150 10		
22 50 08 46 100 18 08		
33 18 08 46 180 28 08		
41 50 08 48 100 81 13		
81 50 01 220 15 10 10		
100 50 08 220 60 21		
100 50 08 230 150 22		
100 25 07 870 15 14		
100 50 11 1000 25 20		
220 50 08 2200 20 88		
220 25 10 2200 80 88		
220 10 10 4000 18 88		
220 25 10 8100 25 82		
870 87 81 740 10000		
870 88 18 2200-11 03V 8 8		
810 28 10 1300-11 03V 8 8		
480 88 28 SEMI		
1000 18 18 CONQUIST GR8		
1000 78 11 254854 28C100		
1000 15 27 T40 10000		
2200 03 27 LWEAR 10c		
2200 10 27 555V .48		
3300 10 27 1430 Ph. .25		
8 00 87 72 L4800 Ph. 1.80		



TOP QUALITY CAPACITORS  
ITW ELECTRONICS  
LOW COST POLYESTER  
A.E.G. TELEFUNKEN  
ELECTROLYTICS &  
TANTALUM

FINER PRESETS CARBON  
VERTICAL & HORIZONTAL

100P-210P 870 1.4  
2k-8k 10K 22K  
810 100K 220K 450P  
1500 120 60 n  
1 V GRABER 4 C  
4 V 3 0500 - CB 05  
n V A 3

**Dipped Tantalum**

Capacitance & Voltage	VAT 85	VAT 128
1 35V 10	8.8 38V	125
15 35V 10	10 38V	125
22 35V 10	10 38V	18
22 35V 10	10 38V	18
81 35V 10	15 38V	18
50 35V 10	15 38V	18
1 38V 10	21 38V	18
1 50V 18	22 38V	18
1.8 38V 18	22 38V	18
2.2 38V 18	81 38V	18
2.2 38V 18	81 38V	18
2.2 38V 18	81 38V	28
2.2 38V 18	81 38V	18
4.7 38V 18	100 38V	28

**Epox Dipped Polyester Capacitors**  
K.C. Series 11, 16 (Phase 108 V G.C. 10%)

Price	Price	Price
001 80 722 04 13 08		
002 08 08 021 04 15 08		
004 08 003-04 18 08		
006-08 008 04 23 01		
0082 008 041 048 27-07		
* 01 008 008-048 27-07		
010-04 008 04 18 100		
018 04 062 04 80 19		
315 04 1 005		

\* Made in T.V. Gambia K10

Send for the  
Mk 1000 008 02- VAT = 1157  
a price list to  
**SPECIAL PRICES FOR  
ELEKTOR READERS.**