

October 1977
45p/USA \$1.50

ELEKTOR

up-to-date electronics for lab and leisure



FREE
PRINTED
CIRCUIT
BOARD
see details
inside

Paranormal electronic
(subliminal perception tester
Kirlian photography,
biorhythm calculator)

elektor 30

Volume 3

Number 10

Editor : W. van der Horst
 Deputy editor : P. Holmes
 Technical editors : J. Barendrecht
 G.H.K. Dam
 E. Krepelsauer
 G.H. Nachbar
 A. Nachtmann
 Fr. Scheel
 K.S.M. Walraven
 Art editor : C. Sinke
 Subscriptions : Mrs. A. van Meyel

decooler

What is a TUN?
 What is 10 n?
 What is the EPS service?
 What is the TO service?
 What is a missing link?

Semiconductor types

Very often, a large number of equivalent semiconductors exist with different type numbers. For this reason, 'abbreviated' type numbers are used in Elektor wherever possible:

- '741' stand for μ A741, LM741, MC641, MIC741, RM741, SN72741, etc.
- 'TUP' or 'TUN' (Transistor, Universal, PNP or NPN respectively) stand for any low frequency silicon transistor that meets the following specifications:

UCEO, max	20V
IC, max	100 mA
t _{fe} , min	100
P _{tot} , max	100 mW
f _T , min	100 MHz

Some 'TUN's are: BC107, BC108 and BC109 families; 2N3856A, 2N3859, 2N3860, 2N3904, 2N3947, 2N4124. Some 'TUP's are: BC177 and BC178 families; BC179 family with the possible exception of BC159 and BC179; 2N2412, 2N3251, 2N3906, 2N4126, 2N4291.

- 'DUS' or 'DUG' (Diode Universal, Silicon or Germanium respectively) stands for any diode that meets the following specifications:

	DUS	DUG
UR, max	25V	20V
IF, max	100mA	35mA
IR, max	1 μ A	100 μ A
P _{tot} , max	250mW	250mW
C _p , max	5pF	10pF

Some 'OUS's are: BA127, BA217, BA218, BA221, BA222, BA317, BA318, BA319, BAY61, 1N914, 1N4148.

Some 'OUG's are: OA85, OA91, OA95, AA116.

• 'BC1078', 'BC2378', 'BC5478' all refer to the same 'family' of almost identical better-quality silicon transistors. In general, any other member of the same family can be used instead.

BC107 (-8, -9) families:

BC107 (-8, -9), BC147 (-8, -9), BC207 (-8, -9), BC237 (-8, -9), BC317 (-8, -9), BC347 (-8, -9), BC547 (-8, -9), BC171 (-2, -3), BC182 (-3, -4), BC382 (-3, -4), BC437 (-8, -9), BC414

BC177 (-8, -9) families:

BC177 (-8, -9), BC157 (-8, -9), BC204 (-5, -6), BC307 (-8, -9), BC320 (-1, -2), BC350 (-1, -2), BC557 (-8, -9), BC251 (-2, -3), BC212 (-3, -4), BC512 (-3, -4), BC261 (-2, -3), BC416.

Resistor and capacitor values

When giving component values, decimal points and large numbers

of zeros are avoided wherever possible. The decimal point is usually replaced by one of the following abbreviations:

p (pico-) = 10⁻¹²
 n (nano-) = 10⁻⁹
 μ (micro-) = 10⁻⁶
 m (milli-) = 10⁻³
 k (kilo-) = 10³
 M (mega-) = 10⁶
 G (giga-) = 10⁹

A few examples:

Resistance value 2k7: 2700 Ω .
 Resistance value 470: 470 Ω .
 Resistance value 4p7: 4.7 pF, or 0.000 000 000 004 7 F...
 Capacitance value 10n: this is the international way of writing 10,000 pF or .01 μ F, since 1 n is 10⁻⁹ farads or 1000 pF.

Resistors are $\frac{1}{2}$ Watt 5% carbon types, unless otherwise specified.

The DC working voltage of capacitors (other than electrolytic) is normally assumed to be at least 50 V. As a rule of thumb, a safe value is usually approximately twice the DC supply voltage.

Test voltages

The DC test voltages shown are measured with a 20 k Ω /V instrument, unless otherwise specified.

U, not V

The international letter symbol 'U' for voltage is often used instead of the ambiguous 'V'. 'V' is normally reserved for 'Volts'. For instance: U_b = 10 V, not V_b = 10 V.

Mains voltages

No mains (power line) voltages are listed in Elektor circuits. It is assumed that our readers know what voltage is standard in their part of the world! Readers in countries that use 60 Hz should note that Elektor circuits are designed for 50 Hz operation. This will not normally be a problem; however, in cases where the mains frequency is used for synchronisation some modification may be required.

Technical services to readers

• **EPS service.** Many Elektor articles include a lay-out for a printed circuit board. Some — but not all — of these boards are available ready-cut and predrilled. The 'EPS print service list' in the current issue always gives a complete list of available boards.

• **Technical queries.** Members of the technical staff are available to answer technical queries (relating to articles published in Elektor) by telephone on Mondays from 14.00 to 16.30. Letters with technical queries should be addressed to: Dept. TQ. Please enclose a stamped, self-addressed envelope; readers outside U.K. please enclose an IRC instead of stamps.

• **Missing link.** Any important modifications to, additions to, improvements on or corrections in Elektor circuits are generally listed under the heading 'Missing Link' at the earliest opportunity.

U.K. editorial offices, administration and advertising:

Elektor Publishers Ltd., Elektor House,
 10 Longport Street, Canterbury CT1 1PE, Kent, U.K.
 Tel: Canterbury (0227) 54430. Telex: 965504.
 Please make all cheques payable to Elektor Publishers Ltd.
 at the above address.

Bank: 1. Midland Bank Ltd., Canterbury, A/C no. 11014587
 Sorting code 40-16-11, Giro no. 3154254.
 2. U.S.A.: c/o World Way Postal Center,
 P.O. Box 80689, Los Angeles, Cal. 90080,
 A/C no. 12350-04207.

Assistant Manager and Advertising : R.G. Knapp
 Editorial : T. Emmens

Elektor is published monthly on the third Friday of each month.

1. U.K. and all countries except the U.S.A.:

Cover price £ 0.45.

Number 27/28 (July/August), is a double issue, 'Summer Circuits', price £ 0.90.

Single copies (incl. back issues) are available by post from our Canterbury office, at £ 0.60 (surface mail) or £ 0.95 (air mail).

Subscriptions for 1977, January to December incl.,

£ 6.25 (surface mail) or £ 11.— (air mail).

Subscriptions for November and December 1977 £ 1.05 (surface mail).

2. For the U.S.A.:

Cover price \$ 1.50.

Number 27/28 (July/August), is a double issue, 'Summer Circuits', price \$ 3.—.

Single copies (incl. back issues) \$ 1.50 (surface mail) or

\$ 2.25 (air mail).

Subscriptions for 1977, January to December incl.,

\$ 18.— (surface mail) or \$ 27.— (air mail).

Subscriptions for November and December 1977 \$ 3.— (surface mail). All prices include post & packing.

Change of address. Please allow at least six weeks for change of address. Include your old address, enclosing, if possible, an address label from a recent issue.

Letters should be addressed to the department concerned:

TQ = Technical Queries, AOV = Advertisements, SUB = Subscriptions, ADM = Administration; EO = Editorial (articles submitted for publication etc.); EPS = Elektor printed circuit board service. For technical queries, please enclose a stamped, addressed envelope.

The circuits published are for domestic use only. The submission of designs or articles to Elektor implies permission to the publishers to alter and translate the text and design, and to use the contents in other Elektor publications and activities. The publishers cannot guarantee to return any material submitted to them. All drawing, photographs, printed circuit boards and articles published in Elektor are copyright and may not be reproduced or imitated in whole or part without prior written permission of the publishers.

Patent protection may exist in respect of circuits, devices, components etc., described in this magazine.

The publishers do not accept responsibility for failing to identify such patent or other protection.

National advertising rates for the English edition of Elektor end/or international advertising rates for advertising at the same time in the English, Dutch and German issues are available on request.

Distribution: Spotlight Magazine Distributors Ltd,
 Spotlight House 1, Centwell Road, Holloway, London N7 7AX.

Copyright © 1977 Elektor publishers Ltd — Canterbury.

Printed in the Netherlands.



Kirlian photography gives the most positive results if living objects are photographed, such as the photographer's own hands. Proponents claim that the photograph is an indication of the 'physic aura' of the subject.

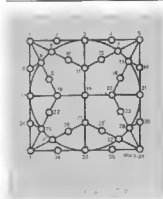

The subliminal perception tester consists of a random number generator which produces one of five distinct symbols on a specially designed display. The unit can also be used to test telepathy, precognition, etc.

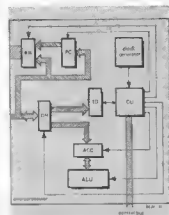

When introducing microprocessors, the first thing to be explained is what they are and what they do. This article goes as far as the block diagram stage; next month the first circuits will appear.



An electronic brain? A robot? No, just an artist's rendering of the combination of electronics and paranormal phenomena in this issue!



selektor	10-01
paranormal electronics	10-04
Kirlian photography	10-05
CCIR TV pattern generator	10-09
impedance variation detector	10-14
The detector can be used to indicate changes of the impedance of the human body, of animals or even of plants, which are the result of muscle contractions, changes in mood, external stimulæ etc.	
subliminal perception tester	10-16
biorhythm program	10-19
missing link	10-21
infra-red stereo transmitter	10-22
Recently, several manufacturers have introduced 'wireless' headphones using infra-red radiation as the transmitting medium.	
slotless model car track (5)	10-26
The infra-red receiver and multiplex decoder are the heart of the car electronics.	
biorhythm calendar	10-32
The 'Biorhythm' theory offers an explanation for the occurrence of emotional 'ups' and 'downs'. This article offers a TTL circuit for calculating and displaying the Biocycles ...	
ioniser	10-35
The Ioniser produces a high concentration of negative ions in the surrounding atmosphere, which many people find stimulating and refreshing.	
touch contacts	10-38
Formant — the Elektor music synthesiser (4) ..	10-40
C. Chapman	
The voltage controlled oscillators (VCOs) are the heart of any synthesiser. The quality of the VCOs ultimately determines the performance of the synthesiser, and because of the importance of the VCO two articles will be devoted to its design and construction.	
introducing microprocessors (2)	10-47
Last month's article provided a brief outline of the development history of computers and their basic architecture. It was intended to give a general impression of what (micro-)processors are supposed to do in a (micro-)computing system. The next step is to find out how they do it: in other words, to take a closer look at the general operating principles common to all microprocessors.	
TUP-TUN-DUG-DUS	10-53
market	10-54
advertiser's index	A-16

paranormal electronics

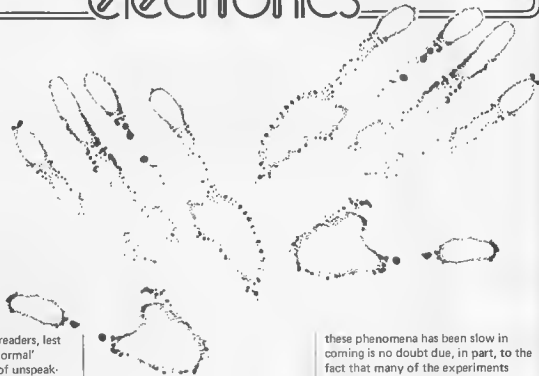

We hasten to reassure our readers, lest our use of the word 'paranormal' should conjure up visions of unspeakable hags dancing around cauldrons with uneatable contents, or of bats capering around the crumbling crenellations of crepuscular Carpathian castles. We are not attempting to delve into the occult, but on the other hand the articles that will be presented in this and the next issue are not a series of 'trick or treat' gimmicks for Hallowe'en. What we are attempting to do is to take a look at some phenomena that are on the fringes of our normal experience, such as the physiological effects of electric and magnetic fields, biofeedback, subliminal perception and precognition, Kirlian photography and so on; areas of investigation in which electronic circuits have many applications. Some of the claims made for these phenomena are now beginning to gain acceptance in scientific circles, others are still treated with scepticism and still others have been discredited. We make no judgements either for or against these claims, we simply provide readers with the means to carry out their own experiments. That scientific recognition of many of



these phenomena has been slow in coming is no doubt due, in part, to the fact that many of the experiments which have been carried out have been distinctly unscientific in character. Much of the equipment that has been used in the past was ill-designed and undoubtedly lent its own bias to the results of experiments, so what we have attempted to do is develop circuits that will function reliably and safely.

Whilst every attempt has been made to ensure adequate electronic performance of the circuits described, and experts in various fields have assured us that the use of these circuits presents no danger to health, we cannot guarantee the validity or effectiveness of any experiments in which the circuits are used, nor can we answer any queries except those concerning the electrical operation of circuits.

For example, the 'Ioniser' described in this issue produces a stream of negative ions which — it is claimed — have a beneficial effect. Whilst we can offer advice should the equipment fail to produce negative ions, we cannot offer any assistance if readers do not feel better after using it!

Kirlian photography

Kirlian photography is not a recent invention - indeed it has been practised for about 50 years. The basic Kirlian equipment consists of a metal plate which is connected to a high voltage AC source. On top of the plate is placed a sheet of insulating material on which the photographic plate is laid, emulsion side up. The object to be photographed is placed on the photographic emulsion and the plate is 'exposed' for several seconds, then developed in the normal fashion.

Kirlian photography gives the most positive results if living objects are photographed, such as the photographer's own hands, leaves, flowers, insects etc., and many proponents of Kirlian photography claim that the photograph is an indication of the 'psychic aura' of the subject. However, a more likely explanation is that the effect is due to the moisture content of the object being photographed.

Kirlian 'cameras' are commercially available, but they are extremely expensive, and a comparable home-made device can be built for a fraction of the cost.

High-voltage generator

The electronics of the Kirlian camera consist entirely of the high voltage generator, its trigger circuit and associated power supply. The voltage required for Kirlian photography is in excess of 20 kV, and the simplest way to generate this is to make use of a car ignition coil, which can be picked up quite cheaply at scrapyards. The coil is driven by the circuit of figure 1, which is basically similar to an existing transistor-assisted electronic ignition circuit. When point X is grounded T1 is turned on, which turns on T2, and current flows through the primary of the coil. If a positive pulse is applied to point X T1 and T2 turn off, and the current through the coil primary decays rapidly. This causes a high voltage to be induced in the coil primary, which is clamped to about 200 V \pm 240 V by zener diode D_Z. The primary/secondary turns ratio of the coil means that this voltage is stepped up to around 20 kV at the H.T. secondary terminal of the coil.

Kirlian photography has little in common with conventional photography. The film is exposed, not optically through a lens system, but by placing the object to be photographed in contact with the film and placing it in a strong AC electric field. This article describes the construction of an inexpensive experimental Kirlian 'camera'.



Trigger circuit

The trigger circuit (figure 2) consists of an astable multivibrator constructed around IC1. The non-inverting input of IC1 is biased to around two-thirds supply voltage, plus or minus the hysteresis voltage provided by R3. If C1 (or C2) is initially discharged the output of the op-amp will be high, charging C1 via R4 and P1 until the voltage across this capacitor exceeds the voltage on pin 3 of the IC, when the output will go low. C1 will then discharge through R4 and P1 until the voltage on C1 falls below the (new) voltage on pin 3. When the op-amp output goes high T1 is turned off, which turns off T2 and triggers the high-voltage generator.

The frequency of the multivibrator may be adjusted by means of P1 and by switching between C1 and C2. This can be particularly interesting when taking Kirlian photographs in colour, since altering the frequency of the electric field varies the colour of the final photograph.

Power supply

The circuit may be powered from a 12 V car battery, or for mains operation a simple stabilised supply may be built as shown in figure 3. The high-voltage generator requires a fairly high current but does not need a regulated supply, so its supply voltage is taken from point Up. The low-current stabilised supply for the trigger circuit is provided by a regulator consisting of a zener diode D4 and series regulator transistor T3.

Construction

A printed circuit board and component layout for the high-voltage generator are given in figure 4. Resistor R3 is not required in this application and is replaced by a wire link. The zener diode D_Z is made up from a chain of 1W zener diodes, and the voltage of each diode is not critical provided the total zener voltage adds up to between 200 and 240 V. Six 36 V or 39 V zeners are suggested.

A p.c. board and component layout for the trigger circuit and power supply are given in figure 5. The only connections required between the two units are to

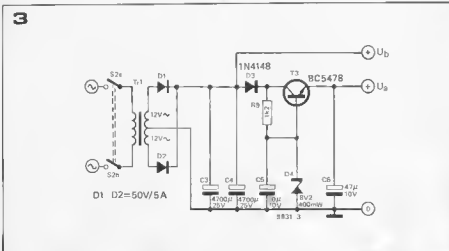
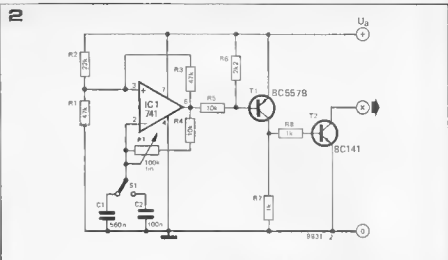
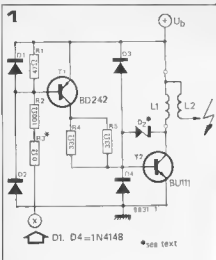

Figure 1. Circuit diagram of the high-voltage generator, which is basically a transistor assisted ignition circuit.

Figure 2. The trigger circuit. This is an astable multivibrator that generates a pulse train to drive the high-voltage generator. The frequency of oscillation may be varied by P1 and S1.

Figure 3. Power supply for the Kirilen camera.

Figure 4. Printed circuit board and component layout for the high-voltage generator, figure 1 (EPS 4523).

Figure 5. Printed circuit board and component layout for the trigger circuit and power supply, figures 2 and 3 (EPS 9831).

Figure 6. View of the Kirilen camera prototype, with the case dismantled.

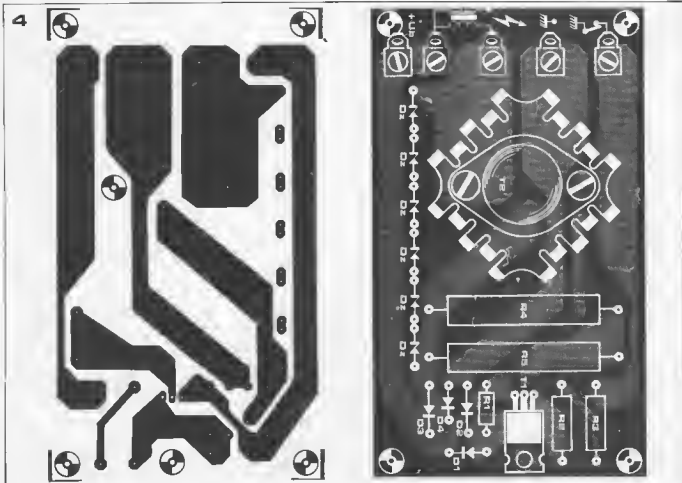

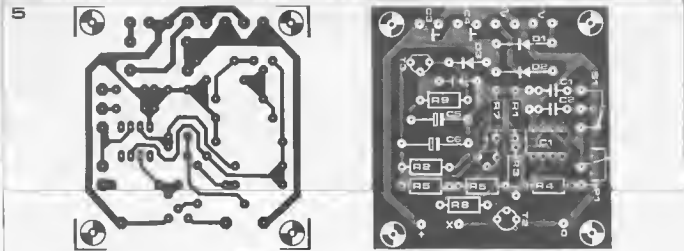

Parts list to figure 4.

Resistors:

- R1 = 47 Ω /1 W
 R2 = 100 Ω /1 W
 R3 = wire link
 R4, R5 = 33 Ω /10 W

Semiconductors:

- D1 . . . D4 = 1N4148
 D_z = series combination of several zener diodes with a total zener voltage between 200 and 240 V/1 W, see text
 T1 = 8D 242
 T2 = BU 111

Miscellaneous:

- L1, L2 = ignition coil (12 volt)
 5 push-on connectors for the transistorised ignition system

Parts list to figure 5.

Resistors:

- R1, R3 = 47 k
 R2 = 22 k
 R4, R5 = 10 k
 R6 = 2k2
 R7, R8 = 1 k
 R9 = 1k2
 P1 = potentiometer 100 k/lin.

Capacitors:

- C1 = 560 n
 C2 = 100 n
 C3, C4 = 4700 μ /25 V
 C5 = 10 μ /10 V
 C6 = 47 μ /10 V

Semiconductors:

- D1, D2 = Si-diode 50 V/5 A
 D3 = 1N4148
 D4 = 8V2/400 mW zener diode
 T1 = 8C 557 8
 T2 = 8C 141
 T3 = 8C 547 8
 IC1 = 741

Miscellaneous:

- Tr1 = transformer 2 x 12 V/1.5 A
 S1 = SPDT
 S2 = DPST



connect point 'X' of the trigger circuit to point '0' of the high-voltage generator, and to connect the '0' and 'p' outputs from the supply to the '0' and '+U₀' inputs of the high-voltage generator. The primary of the ignition coil is connected to the output terminals of the high-voltage generator, and the H.T. terminal of the coil connects to the metal plate.

In view of the high voltages generated, considerable care should be taken with the housing for the circuits, and figures 6, 7 and 8 give some indication of the type of construction that should be adopted. The entire case for the prototype was fabricated from acrylic sheet, which was chosen because of its good insulating properties. The box was made of 5 mm thick sheet, which is the minimum consistent with good insulation and reasonable mechanical strength. The lid and sides of the box should be made as a single unit, the circuits being mounted on the (removable) base.

The metal plate is a piece of aluminium 300 mm x 200 mm and between 1 mm and 2 mm thick. The H.T. connection to the plate is made by drilling and countersinking a 3 mm hole in one corner of the plate and inserting an M3 screw with countersunk head so that the head is flush with the plate. Nuts and a solder tag may then be attached, as shown in figure 9.

To maintain good insulation the lid of

the box must not be pierced with any holes, so the aluminium plate must be attached to the underside of the lid using epoxy adhesive. To allow good adhesion the acrylic sheet should be roughened with emery paper at the points where the adhesive is to be applied.

Finally, to avoid the possibility of an electrical discharge tracking around the edges of the lid, the joints between the lid and the sides of the box should be sealed with silicone rubber. All the components with the exception of S1, S2 and P1 can be mounted on the base of the box, which can be attached to the lid/sides assembly either by a hinge down one edge or by screws into tapped holes in the box sides.

Using the Kirlian camera

To avoid fogging of the photographic film by light, Kirlian photography must obviously take place in total darkness. Any type of photographic film may be used, either monochrome or colour, but the plate should be of sufficient size to accommodate the object being photographed. The film is placed, emulsion side uppermost, on the lid of the box. The object to be photographed is then placed on the film and is weighted down with a piece of acrylic sheet. If a human hand is to be photo-

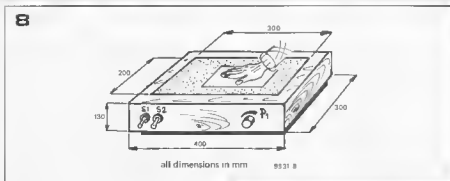
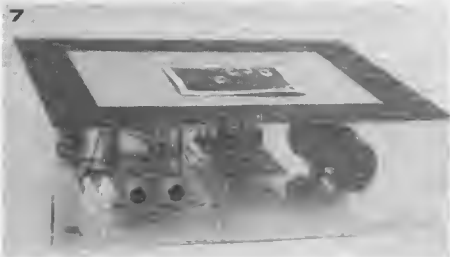

Warning

In view of the high voltages used for Kirlian photography, extreme care should be taken with the construction and use of the Kirlian camera. At the risk of being repetitious it must be stressed that the insulating lid of the box must be at least 5 mm thick and should have no holes in it, and the joints at the edges of the lid must be well-sealed. No metal screws should be used in this part of the construction. The controls P1, S1 and S2 should be adequately insulated types, with plastic spindles, knobs, etc.

The camera should never be operated with the box dismantled, as touching the metal plate or H.T. terminal of the coil could result in a severe electric shock.

Never use the camera in damp conditions, and especially do not try to process the film in the darkroom at the same time as using the camera, since using the camera with damp hands is inviting trouble.

Finally, it is recommended that the Kirlian camera is not used by anyone suffering from a heart ailment.

Figure 7. General view of the prototype of the Kirlian camera.

Figure 8. Dimensions of the Kirlian camera.

Figure 9. Showing the H.T. connection to the aluminium plate.

Figure 10. Kirlian photograph of a fresh leaf. Exposure time 2 seconds, frequency 50 Hz.

Figure 11. Kirlian photograph of three old leaves taken with the same exposure values as figure 10.



graphed this is simply placed palm down on the film, there obviously being no need for the weight.

The camera is then switched on for an exposure time of between 1 and 5 seconds, after which the film is developed in the normal manner. No details of film development will be given as this is outside the scope of the article, and it is assumed that readers who wish to experiment with Kirlian photography will already be familiar with normal photographic processes.

When taking colour photographs the trigger frequency has an effect on the predominant colour of the photograph, and this effect can be experimented

with by varying the setting of P1 and S1.

Figures 10 and 11 show the sort of results that can be expected. Figure 10 is a Kirlian photograph of a fresh leaf, taken with an exposure time of 2 seconds at a frequency of 50 Hz., while figure 11 is a photo of three old leaves, taken with the same exposure conditions.

Literature:

J.O. Pehek, H.J. Kyler, D.L. Faust: 'Image modulation in Corona discharge photography', *Science*, Oct. 1976, Vol. 194 nr. 4262, p. 263.

CCIR TV pattern generator

(2)

To recap briefly on last month's article, so that the reader will not become too lost in the proliferation of gating circuits, the block diagram of the sync generator is reproduced in figure 1. The sections of the circuit already discussed are those blocks not assigned a figure number, i.e. 4 MHz timebase, 7.5 H, 2.5 H, 25 H and sync + video mixer. These sections of the circuit produce certain basic time intervals required in the generator. Since these basic pulses are used, not only in the sync circuits, but also in the pattern generator module, the sections of the circuit so far described are mounted on a motherboard, together with the power supply, so that the signals can be routed out to the daughterboard modules by simple busbars running along the motherboard printed circuit (see figure 17 part 1). The sections of the circuit to be described in this part of the article are assigned figure numbers 2 to 6 in the block diagram, and all these sections are mounted on the first of the modules.

Line Blanking Interval

In common with all the other pulses which make up the composite sync waveform, the line blanking interval is obtained by gating together other pulses and outputs from the clock/divider chain. The function for the line blanking interval is simply:

$$\text{line blanking} = (\overline{Q5} + \overline{Q6}) \cdot \overline{Q7} \cdot (\overline{Q8} + 7.5 \text{ H}).$$

Figure 2 shows the practical circuit of the line blanking function. Capacitors C4 and C14 are included to suppress any switching spikes caused by propagation delays.

Line Sync Pulse

Generation of the line sync pulse is considerably more complex than generation of the line blanking interval, since it consists of a 4.7 μs pulse that occurs after the 1.5 μs 'front porch' of the line blanking interval. The gating shown in figure 3, up to the output of N17, serves simply to generate 4.7 μs pulses. However, the pulses at the output of N17 occur several times during one line

The second part of this article completes the description of the circuits of the CCIR standard generator, and gives the layout of the daughter p.c. board on which the rest of the circuit is mounted. The unit, as it stands, will then generate a TV synchronising signal to CCIR standards, to which various video signals can be added, for example from the pattern generator module which will be described in part 3.

period, whereas the line sync pulse must occur only once. Accordingly, the output of N17 is gated with the line blanking interval, which ensures that only one 4.7 μs line sync pulse appears per line period.

The equation of the line sync function is:

$$\text{line sync} = (\overline{Q2} \cdot \overline{Q3} \cdot \overline{Q4} + Q4 \cdot \overline{Q5} + \overline{Q4} \cdot Q5 + \overline{Q1} \cdot \overline{Q2} \cdot \overline{Q3} \cdot Q5) \overline{Q6} \cdot \text{line blanking}$$

Field Equalisation Pulses

The function for the field equalisation pulses is given by the equation:

$$\text{field equalisation} = (\overline{Q0} + \overline{Q1} + \overline{Q2} + \overline{Q3} + \overline{Q4}) \cdot \overline{Q5} \cdot \text{line sync}$$

The gating for this function is shown in figure 4.

Field Sync Pulses

The field sync pulses that appear between the two sets of equalisation pulses during the field blanking interval have the same repetition rate as the equalisation pulses, (32 μs) but are much broader (27.4 μs as against 2.35 μs). The equation for deriving the field sync pulses (figure 5) is:

$$\text{field sync} = (\overline{Q2} \cdot \overline{Q3} \cdot \overline{Q4} + Q4 + Q5 + Q6 + Q7) \cdot ((\overline{Q1} + \overline{Q2}) \overline{Q3} \cdot \overline{Q4} + \overline{Q5} + \overline{Q6} + \overline{Q7}).$$

This completes the functions required to generate a CCIR standard sync signal for monochrome signals. However, to make provision for the later addition of colour it is necessary to generate a 'colour burst enable' signal, which will allow the chroma subcarrier to be inserted on the back porch of the line-blanking interval.

The equation for this function is:

$$\text{burst enable} = \text{line blanking} \cdot (\overline{Q3} \cdot \overline{Q4} \cdot Q5 + (\overline{Q1} \cdot \overline{Q2} + \overline{Q3}) \cdot \overline{Q4} \cdot \overline{Q6}).$$

The gating for this function is given in figure 6.

Complete Circuit of the CCIR sync generator

Although discussing partial circuits facilitates understanding of the functions that make up the sync signal, it may

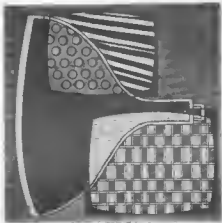

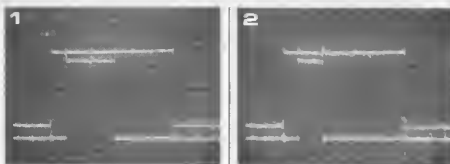

Figure 1. Block diagram of the sync generator. The blocks not assigned figure numbers have already been described.

Figures 2, 3, 4, 5 and 6. Getting circuits to derive line blanking, line sync, field equalisation, field sync and burst enable signals respectively.

Photo 1. Line sync (lower trace) compared to line blanking.

Photo 2. Field equalisation (lower trace) compared to line blanking.

Photo 3. Field sync (upper trace) compared to line blanking.

Photo 4. View of the complete video waveform (lower trace) during the field blanking interval.

Photo 5. Expanded view of the equalisation and field sync pulses (lower trace).

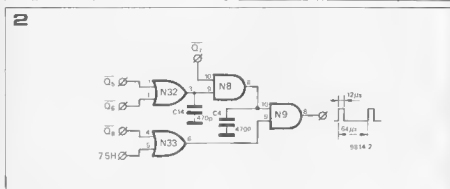
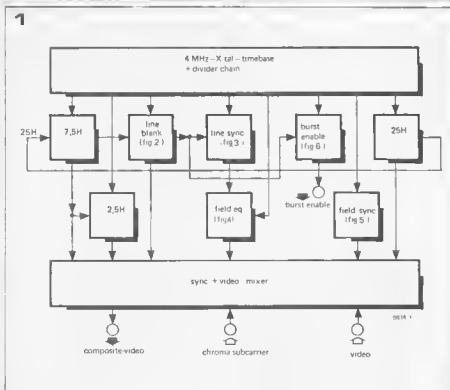

Parts list for figure 8

Resistors:

R107... R111 = 4k7 (supply line decoupling, not shown in circuit. See also part 1 figure 18).

Capacitors:

C4, C5, C7, C14 = 470 p
C6, C13 = 330 p
C107... C111 = 120 n (supply line decoupling, not shown in circuit. See also part 1 figure 16)
C126... C130 = 10 n

IC's:

IC8 (N9... N12) = 7408
IC9 (N13... N16) = 7408
IC10 (N17, N18, N28, N29) = 7408
IC11 (N19... N22) = 7408
IC12 (N23, N27, N30, N31) = 7408
IC14 (N32... N35) = 7432
IC15 (N38, N52, N53) = 7432
IC16 (N37, N38, N39) = 7432
IC17 (N40, N41, N42, N45) = 7432
IC18 (N43, N44, N46, N47) = 7432

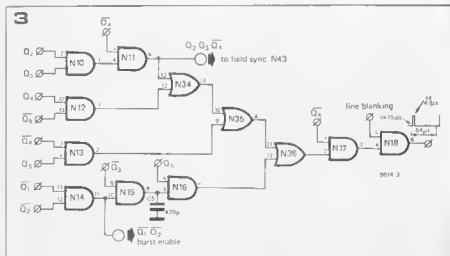

tend to obscure the overall picture of the generator, and for the sake of completeness the full circuit is given in figure 7. The sections of the circuit described last month were, of course, mounted on the motherboard described in that article, whereas the circuits discussed this month are mounted on the first of the four modules for which provision is made. The p.c. board and component layout for the module are given in figure 8. In order to avoid the

necessity for an expensive double-sided p.c.b., a considerable number of wire links are used on the board, and great care must be taken not to omit any of these.

The module may be mounted on the motherboard using wire links or, if the modules are to be removable, IIT/Cannon GO 9 series connectors may be used. These are supplied in strips that may be cut to the appropriate length. The module should be

mounted with the component side of the board facing the component end of the motherboard.

Testing

Since the circuit is entirely digital the only meaningful way of testing it is to use an oscilloscope to view the waveforms. Even then, any old 'scope' will not do, but an instrument with stable and reliable triggering must be used.

Photos 1 to 5 show the waveforms that should be seen. Photos 1 and 2 show respectively the line sync and field equalisation pulses on the lower trace, with the line blanking interval shown on the upper trace as a reference. In each case the signal starts after the 1.5 μ s front porch of the line blanking interval, but the duration of the line sync is twice that of the equalisation pulse.

Photo 3 shows the field sync pulse on the upper trace compared with the line blanking on the lower trace. Here again the pulse starts 1.5 μ s after the leading edge of the line blanking interval, but the duration of the field sync pulse is much longer than the line blanking interval.

Photos 4 and 5 give an overall view of the sync waveform during the field blanking interval. In photo 4 the upper trace shows the 25 H signal, while the lower trace shows a modulated video waveform. At the start of the 25 H period the video modulation is suppressed. Five equalisation pulses appear, followed by five field sync pulses, followed by a further sequence of five equalisation pulses. The rest of the 25 H period is occupied by line blanking pulses.

The lower trace of photo 5 shows an expanded view of the equalisation and field sync pulses during the 7.5 H period (upper trace). The difference between field sync and equalisation can clearly be seen, plus the fact that these pulses have only half the spacing of the line blanking pulse at the right of the trace.

The next part of this article will discuss the pattern generator module, which will provide a variety of patterns for TV testing.

4

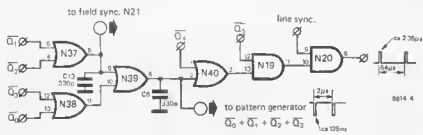

5

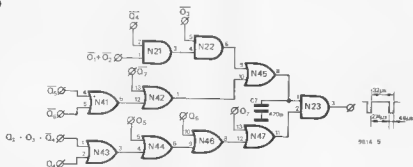

6

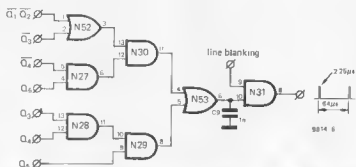

4

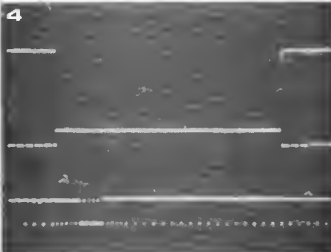

5

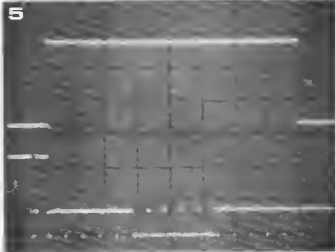

impedance variation detector

First of all, a brief recap of the conventional method of measuring an unknown resistance. An internal battery in the multimeter causes a small current to flow through the object whose resistance is being measured. The size of this current is inversely proportional to the value of the unknown resistance, which is indicated by the deflection of the meter needle.

It is clear that, particularly when measuring high resistances with sensitive instruments, this current is easily affected by external sources of interference such as static electricity, induced voltages etc. Even when the system has been screened against such external interference, there remains such sources of error as ageing of the instrument.

The block diagram in figure 1 shows the alternative method of measurement. An LC-oscillator (block 1) produces a constant frequency and amplitude 10 kHz AC-voltage. The stability of the frequency is obtained by choosing a suitable type of oscillator, whilst the amplitude is held constant by an ALC (Automatic Level Control; see block 2). So as not to overtax the ALC, an extra buffer stage is included (see block 3) which has a high internal resistance. The impedance between the measurement electrodes and the internal resistance of the buffer stage together form a voltage divider. This voltage divider is intended not only for the 10 kHz signal, but also for unwanted transients.

Since only the divided-down 10 kHz signal is to provide the reference for the measured impedance, it is first pre-amplified by block 4 and then cleaned of any interference by the bandpass filter of block 5. The insertion loss of the filter is compensated for by the succeeding amplifier stage (block 6). All that is now needed to indicate the value of the measured impedance is a suitable detector circuit (block 8), the DC output voltage of which is proportional to the impedance of the measured object.

However, since the circuit is intended to register changes in impedance, the detector circuit is followed by a variable gain amplifier stage (block 9) and a voltage controlled oscillator (block 10).

In order to measure small changes in high resistance circuits, the use of a simple ohmmeter is not sufficient, since the measurement can be distorted by the effect of voltage transients originating both from the object being measured as well as other sources of interference. These errors can be largely eliminated however, by employing an AC-voltage of a suitable frequency (e.g. 10 kHz) along with a selective filter. This method will measure not only changes in resistance, but will also indicate variations in the AC impedance of a circuit.

The detector can be used to indicate changes of the impedance of the human body, of animals or even of plants, which are the result of muscle contractions, changes in mood, external stimulæ etc.

The frequency of the audible signal produced by the loudspeaker varies with changes in the measured impedance. The automatic gain control (block 7) ensures that the amplitude of the 10 kHz signal remains constant when there is no variation in the measured impedance. It determines the free running frequency of the VCO and thus the pitch of the 'steady state' reference signal. The frequency of this signal was chosen so that even quite small changes in pitch would be clearly audible. The AGC responds relatively slowly, so that gradual changes in impedance are also clearly discernible. When, for example, the impedance of the object being measured increases, the output voltage of the detector rises, causing a change in the pitch of the loudspeaker signal. If the impedance remains at this new level, then the amplitude of the AGC signal at the input of the detector gradually falls back to its original value and the pitch of the loudspeaker signal is the same as it was before the change in impedance.

The circuit

Figure 2 shows the circuit diagram of the 'transmitter' stage of the detector, which contains the LC-oscillator, the ALC and the buffer stage. The LC-oscillator is built round transistor T1; the resonant circuit consisting of L1, C1, C2, C3 and C4 determines the frequency of the oscillator. The positive feedback path runs from the emitter via the capacitive voltage divider C3/C4 to the base of T1.

This type of oscillator is distinguished by its frequency stability. In order to also maintain a constant amplitude, the ALC circuit round T2 was added. If the amplitude of the signal at the collector of T1 increases, T2 is turned on harder, so that the voltage at the base of T1 drops, thus causing the amplitude of the oscillator signal to decrease. As a result of the high Q-factor of the LC-resonant circuit, the voltage across C2 is greater than that across the whole circuit.

In order not to overload the oscillator and to reduce feedback, a buffer stage round T3 is included. This buffer stage has a high input and output impedance. The high output impedance is necessary in view of the very high impedance of

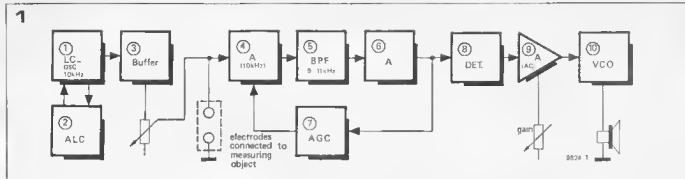

Figure 1. Block diagram of the impedance variation detector.

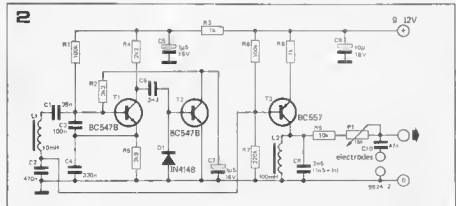
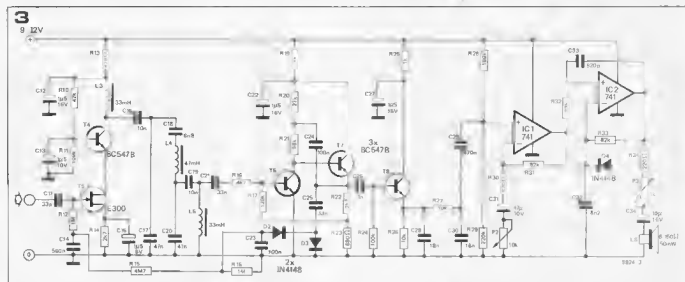

Figure 2. Circuit diagram of the 'transmitter': it produces an amplitude- and frequency constant 10 kHz signal.

Figure 3. In the 'receiver' the 10 kHz signal is amplified and cleaned of transients. A delayed response automatic gain control assures that only changes in impedance are registered as fluctuations in the pitch of an audible reference signal.



the object being measured, which together with the output impedance of the buffer stage constitutes a voltage divider. The division factor is variable by means of potentiometer P1.

The collector circuit of T3 contains an LC-parallel-resonant circuit (L2/C8) with a resonant frequency of 10 kHz. At this frequency the circuit has an extremely high, purely resistive impedance, so that the voltage gain is at a maximum at 10 kHz.

Figure 3 shows the circuit diagram of the 'receiver'. The input stage has a high impedance so as not to overload the voltage divider of the transmitter. The 10 kHz signal from the voltage divider is first amplified then fed to the selective LC-filter (C16 ... C21/L3 ... L5). Since the bandpass filter must be terminated in a specific impedance, it is succeeded by a virtual-earth amplifier (T6/T7). The characteristic impedance is determined by R16. Between this

amplifier stage and the input stage is the control loop of the automatic gain control, consisting of R12, R15, R18, C14, C23, D2 and D3. If the amplitude of the input signal increases, then the output signal at the emitter of T7 will follow course. Diodes D2 and D3 produce a negative rectified voltage, and this is fed via the RC-network R15/C14 to the gate of transistor T5, so that the gain of the input stage (T4/T5) falls. Since the RC-network has a long time constant, this means that quite gradual changes in impedance will be detected.

The 10 kHz signal is next fed to the detector circuit round T8, whose output is AC-coupled to the voltage amplifier IC1. The AC-coupling means that the amplifier reacts only to changes in the DC-voltage produced by the detector and hence only to changes in the impedance of the object being measured. The amplified voltage differences are used to control a VCO (IC2), which

converts the changes in impedance into changes in the pitch of an audible signal. The sensitivity of P2, and the volume of the loudspeaker signal by P3.

In conclusion

It will be apparent from the foregoing that impedance and resistance are two related, but by no means identical, quantities. The title 'impedance variation detector' was chosen since it is impossible to determine whether the potentially present inductance or capacitance of the object being measured remains constant or not. If, however, the intention is to measure only changes in resistance, then the imaginary components (inductance, capacitance) of the impedance cannot be included in the measurement. These components can be determined by calculating the phase angle between the input and output voltages of the voltage divider. ■

subliminal perception tester

The circuit basically consists of a random number generator linked to two displays. The test person looks at one of the displays whilst the second display is situated outside his field of vision. Shortly after the start button is pressed, the decimal point on the first display lights up briefly, indicating that a number is about to be displayed. This completely random number is displayed for a sufficiently short time as to be imperceptible at a conscious level. The test person can then ascertain whether he has perceived the number subliminally by guessing the answer and checking it against the second display, which displays the number continuously. Other experiments for which the circuit may be used include a test for telepathic communication and a test for precognition. In the telepathy test, the help of another person is required, preferably someone who is felt to have an empathy with the test person. The latter is required to guess the random numbers seen by his partner on the continuous display.

In the test for precognition, the idea is to try and guess the numbers before they are displayed, again with the help of a second person who checks the results.

The circuit

Transistors T2 and T3 in figure 1 form a one-shot pulse generator. When push-button S1 is depressed, T2 turns on causing C4 to charge. Since the collector of T2 is fed with a 100 Hz waveform from the output of the bridge rectifier D1...D4, the collector voltage will vary between 0 and 25 V, which means that C4 is charged to between approx. 8 and 25 V. This voltage is used to control VCO1 whilst VCO 2 is controlled by T3. The free running frequency of VCO 1 is approx. 1/3 Hz and that of VCO 2 approx. 30 kHz. As long as VCO 2 is not blocked by D14 or D15, its output is fed to IC3, which is connected as a decade counter. As soon as the output of N2 goes low, VCO 2 is blocked by D14 and flip-flop FF2 causes this condition to be maintained until the start button is pressed once more.

The state of the counter is shown on the

The ban on subliminal advertising has led to a wider interest in this unusual psychological phenomenon. The following circuit offers the possibility of testing one's response to subliminal messages and may also be used for various other 'parapsychological' experiments.

second display via IC6. With switch S2 in the open position, the display will not light up until S3 is pressed; if S2 is closed the display will light continuously.

Gates N5 and N6 together form a monostable multivibrator, which triggers IC7 to display the state of the counter on the first display. The display-time is adjustable by means of potentiometer P1. The circuit rounds the gates N7 and N8 ensures that the decimal point lights up shortly before the random number appears on the display. Since the VCO circuits require a voltage of approx. 15 V, but two TTL ICs are also used, this means that two supply voltages are needed. A suitable supply stage is shown in figure 2. To reduce the dissipation of T1 to a minimum, the second display is fed by an unswitched voltage. The current-limiting resistors R23...R29 therefore have a higher value than normal. During construction care should be taken to ensure that all COSMOS ICs have a 15 V supply, with the exception of IC5 (type 4050) which, like the TTL ICs, should be fed off 5 V.

Alternative version

With 7-segment displays there is the danger that a '3' or a '0' may be mistaken for an '8'. This drawback can be avoided by adopting an alternative set of symbols. Figure 3 shows an arrangement of LEDs which permits the following symbols to be displayed:

1. a star
2. a square
3. a circle
4. a cross
5. two zig-zag lines

If this arrangement is adopted, then the decoder and display circuit must be altered accordingly (see figure 4). The A-, B- and C-inputs of the decoder drivers IC6' and IC7' (type 7445) are connected to the corresponding outputs of the counter (IC3), via the interfacing gates N10...N12. The reduction in the number of symbols means that the counter need only count to 5. This is achieved by connecting D16 to the C — and not to the D — output of the

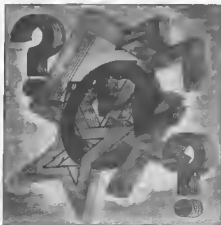

1

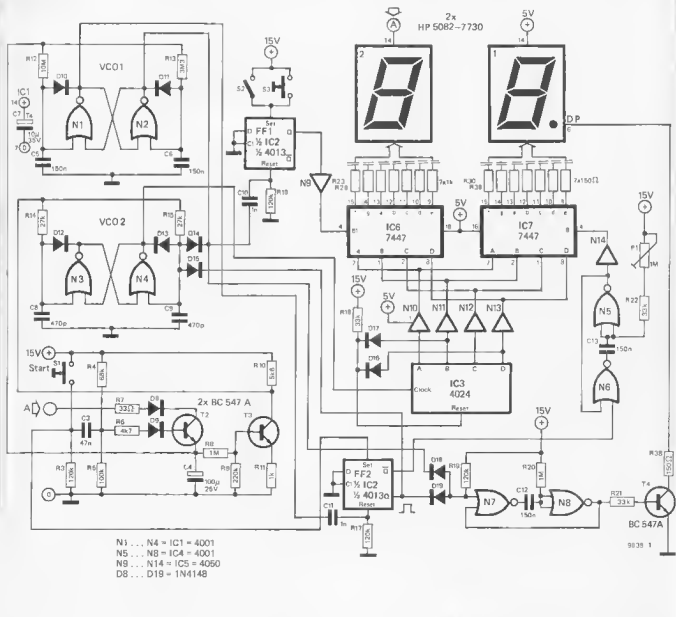

Figure 1. Circuit diagram of the subliminal perception tester.

2

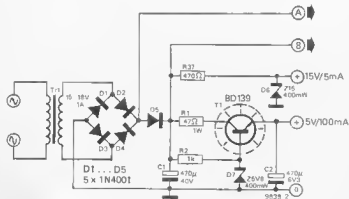

Figure 2. Supply stage for the circuit in figure 1. A 0.5 A transformer would be sufficient for 7-segment displays, but not for discrete LED-displays.

3

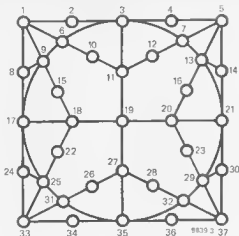
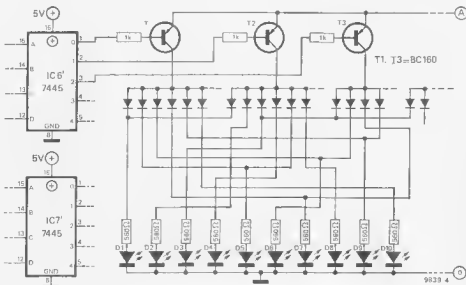

Figure 3. The alternative (LED-) display to prevent the test person confusing different numbers. Each display now requires 37 LEDs.

Figure 4. The circuit of the decoders for the alternative LED-display.

4a



4b

		Sym- bol		LED no.																																								
C	B	A		1	2	3	4	5	6	7	8	9	10	11	12	13	14	15	16	17	18	19	20	21	22	23	24	25	26	27	28	29	30	31	32	33	34	35	36	37				
0	0	0	1	X	X	X	X	X	X	X	X	X	X	X	X	X	X	X	X	X	X	X	X	X	X	X	X	X	X	X	X	X	X	X	X	X	X	X	X	X	X			
0	0	1	0	X	X	X	X	X	X	X	X	X	X	X	X	X	X	X	X	X	X	X	X	X	X	X	X	X	X	X	X	X	X	X	X	X	X	X	X	X	X	X		
0	1	0	1	X	X	X	X	X	X	X	X	X	X	X	X	X	X	X	X	X	X	X	X	X	X	X	X	X	X	X	X	X	X	X	X	X	X	X	X	X	X	X	X	X
0	1	1	1	X	X	X	X	X	X	X	X	X	X	X	X	X	X	X	X	X	X	X	X	X	X	X	X	X	X	X	X	X	X	X	X	X	X	X	X	X	X	X	X	X
1	0	0	0	X	X	X	X	X	X	X	X	X	X	X	X	X	X	X	X	X	X	X	X	X	X	X	X	X	X	X	X	X	X	X	X	X	X	X	X	X	X	X	X	X

counter. The D-inputs of the decoders are used to blank the displays: gate N9 is connected between the Q-output of FF1 and the D-input of IC6', and gate N13 is connected between the output of N14 and the D-input of IC7'.

Outputs 0...4 (pins 1...5) of the decoders are each connected via a resistor to the base of a BC160 transistor. The collectors of these transistors feed a diode decoding matrix for the LEDs.

The table lists those LEDs which must light up to produce a specific symbol. The numbering of the table coincides with the numbering in figure 3. The

partial circuit in figure 4 shows the first 10 LEDs; it can easily be completed on the basis of the table. As an example let us take LED no. 3, which is in the middle of the top line of the display. This LED must be lit for symbols 2, 3 and 4, which means that it must be connected to the collectors of the transistors which are switched by outputs 2, 3 and 4 of the decoders. The various diodes are necessary to prevent wrong LEDs from lighting up.

An extra LED is needed to replace the decimal point which informed the user that a number was about to appear on the first display. This LED is connected

to the collector of T4 and via a 560 Ω resistor to the +5 V supply. The display which is driven by IC7' should be fed from point B of the supply stage. ■

biorhythm program

Almost everyone experiences 'ups and downs'; there are days when nothing seems to go right and you feel devoid of energy or inspiration; then again there are days when everything 'clicks' and you could take on the world. Until recently it was assumed that these changes in mood were a purely random occurrence and therefore could not be predicted in advance. However there is a growing interest in the theory which interprets these seemingly haphazard variations in mood as the result of fluctuations in a person's 'bioclock'.

The originators of the theory, a certain Wilhelm Fliess (1858-1928) and Hermann Swoboda (1873-1964), proposed that the way a person feels at any given time is determined by three dominant biological cycles. These cycles are the physical, which has a period of 23 days, the emotional, with a period of 28 days, and the intellectual cycle, with a period of 33 days. These cycles can all be represented in the form of a sine-wave, with a positive and a negative half-cycle, the amplitude of the wave-form indicates the intensity of the condition represented by the curve, the positive portion of the curve represents a favourable influence and vice-versa. The days on which the curves intersect the zero-crossing point are considered to be particularly critical.

The theory further states that all three cycles begin at birth, so that when compiling a rhythmogram (graph of the three cycles over a period of time) this date is of decisive importance. If the number of days which have elapsed between the date of birth and the current date are divided by the number of days in a complete cycle, then the remainder represents the stage of that cycle for the day in question. It is thus possible to compile a rhythmogram of a person for a given period of time such as a month or even a whole year.

Figure 1 shows an example of a rhythmogram; it is that of the former Chancellor of West Germany, Willy Brandt, for the month of May 1974. Brandt was born on the 18th of Dec., 1913; he became Chancellor in 1969, a post which he was forced to quit in May, 1974 when it transpired that one of his most trusted advisers had been working

This article provides a program for the HP-65 programmable calculator from Hewlett-Packard with which it is possible to determine, and even predict in advance, the state of one's 'bioclock' on any given day.

as a spy for the East Germans. His rhythmogram for that month shows a markedly negative tendency at the point in time of his resignation (arrowed). Such examples could be multiplied almost indefinitely. However, whether they allow any conclusions to be drawn as to the validity of the above theory is a question we leave to our readers to answer.

The program

Since a large amount of tedious calculation is required to compile a rhythmogram, the simplest solution is to use a calculator. A programmable calculator offers the advantage that once the appropriate program has been read in, it is possible to obtain any rhythmogram simply by supplying the relevant dates.

Table 1 shows the complete 83-step program used to determine the start of the various biorhythm cycles. The program functions as follows: the number of days from the 1st of January 1900 to the date of birth (not forgetting leap years) is first calculated, and this number is then subtracted from the number of days between the 31st of December 1899 and the date of the day in which we are interested. The result is obviously the age of the person in days plus an extra day to allow for the fact that it is the current and not the previous day for which the program must be calculated. The above number is then divided by the number of days in the physical cycle (23) and the remainder

Figure 1. Rhythmogram of Willy Brandt for the month of May 1974. Willy Brandt was born on the 18th of December, 1913.

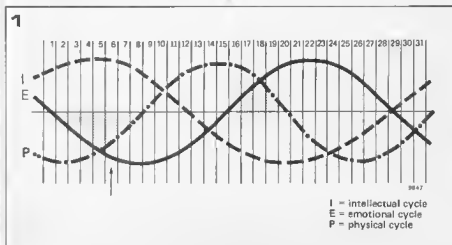

(not the quotient) is displayed by the calculator

By operating the R/S key the calculator will divide by 28 (for the emotional cycle) and 33 (for the intellectual cycle). Steps 37 through 40 in the program ensure that the number of days in the cycle being calculated are displayed after the decimal point. Thus, the 12th day in the 28-day cycle will be displayed as 12.28.

The calculator may be programmed in the 'W/PRGM' position. When the program has been read in, the calculator is switched over to 'RUN' and the relevant data are read in following the sequence shown in table 2.

The program is valid for dates between the 1st of March 1900 and the 28th of February 2100.

As a final note, those readers not in the possession of an HP 65 can perform the calculation by hand, as follows:

1. Take particular note that January and February are considered to be the 13th and 14th months of the *previous* year.

2. Multiply the year of birth (or the preceding year for January or February) by 365.25; omit the digits after the decimal point ('Integer'), so that ...123.75 becomes ...123.00.

3. Add 1 to the month of birth, so that March becomes 4, November is 12, and February is 15(!). Multiply the result by 30.6, again omit any digits after the decimal point, and add the result to the number found in step 2.

4. Add the day of birth.

5. Repeat steps 2...4 for the date of interest.

6. Subtract the result found in step 4 from the result found in step 5, and add 1.

7. Divide this number by 23; the remainder (the digits after the decimal point) can be multiplied by 23 to find the position in the 23-day cycle.

8. Repeat step 7 for the 28-day and 33-day cycles.

INTERNATIONAL ELECTRICAL ELECTRONICS CONFERENCE AND EXPOSITION

Sept. 26 - 28, 1977 / Automotive Building, Exhibition place Toronto, Canada.

Coinciding with the launching of our Canadian edition, we will be exhibiting various construction projects on stand no. 115 at the I.E.E.E. exposition in Toronto. These projects will be selected from the hundreds of practical designs published each year in **Elektor**.

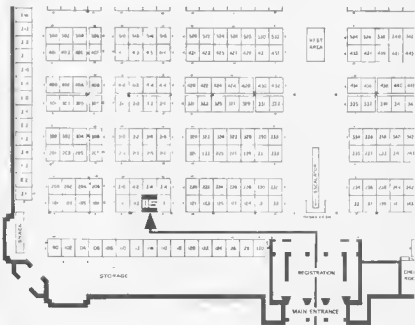

Our editorial and commercial staff look forward to meeting you there!



SOL-200 SQ decoder

Elektor 17, September 1976, p.938. In this article, reference is made to an SQ test record, the SQT 1100. Several readers have asked us where this can be obtained. We have now been informed by CBS that the SQT 1100 test record can be ordered from: CBS records, 17-19 Soho Square, London W1V 6HE, England. Only a very limited number are normally in stock, however, so a sudden increase in demand could lead to long delivery times.

Knotted handkerchief

Summer circuits 1977 (E27/28), circuit no. 32. To our amazement, we have succeeded in blowing up one miniature loudspeaker with this circuit.

Although the output power is only 8 mW, the circuit was deliberately designed to produce a tone close to the resonance frequency of these units, in order to obtain a penetrating sound.

When using a miniature loudspeaker it is therefore advisable to increase the value of R7 to 220 Ω. If an earpiece insert is used, the specified value (100 Ω) can be maintained.

coming soon

- more paranormal electronics
- experimenting with the SC/MP
- video biofeedback

infra-red stereo transmitter

Although infra-red transmission systems have been around for some time, it is only recently that stereo transmission has been feasible using relatively inexpensive gallium arsenide LEDs, which operate outside the visible spectrum at a wavelength of approximately 950 nm. There are several methods of impressing the audio signal onto the radiation emitted by an LED. The simplest method, which may be used only for mono transmission, is to modulate the brightness of the LED directly with the audio signal. The modulated signal is picked up by a photo-transistor whose leakage current varies in sympathy with the modulation of the received light.

The main advantage of this method is low cost, but it has several disadvantages. It is useless for stereo since there is no method of transmitting two independent information channels. It is also subject to interference from other sources of infra-red such as mains driven lamps, street lighting, television sets, the sun, and even matches, cigarette lighters, domestic fires etc.

In order to eliminate these problems and to allow stereo transmission, frequency modulation was chosen as the transmission mode. With this method the infra-red light source is pulsed on and off at a high frequency and the audio signal is used to modulate the frequency at which the LED flashes. This method is analogous to FM radio where the frequency of an r.f. carrier is modulated.

In the infra-red transmission system stereo transmission is effected by using a different carrier frequency for each channel. This eliminates the necessity for a complicated multiplex encoding and decoding system, as is used in FM radio to modulate two channels onto a single r.f. carrier. In order that different manufacturers' systems should be compatible standards were agreed upon as follows: left channel centre frequency 95 kHz, right channel centre frequency 250 kHz, peak frequency deviation ± 50 kHz.

Figure 1 shows the block diagram of the transmitter, the two channels of which are identical with the exception of the carrier frequencies. Each signal is fed, via a volume control, into a pre-empha-

Headphones have long been popular with hi-fi enthusiasts, since they provide good-quality reproduction at a fraction of the cost of loudspeakers, and can be used to listen to music at full blast without disturbing other members of the household. However, they do suffer from one drawback, namely the connecting cable, which invariably becomes entangled with the furniture, and prevents the listener from moving freely about the room.

Recently, however, several manufacturers have introduced 'wireless' headphones using infra-red radiation as the transmitting medium. This article describes an infra-red transmitter that is compatible with many of these and which may be connected into most hi-fi systems. The circuit of this transmitter is a design provided by Sennheiser, who market headphones fitted with a suitable infra-red receiver.



sis network with a 50 μ s time constant. This stage boosts the high-frequency components of the signal relative to the lower frequencies, the reason for this procedure being that the energy content of most programme material falls off at high frequencies, and pre-emphasis is thus necessary to maintain a reasonable signal-to-noise ratio. An overload detector circuit monitors the signal level and lights a LED if it exceeds the permitted maximum, as this would cause excessive deviation of the carrier frequency.

The pre-emphasis is followed by an amplifier stage, the output of which is used to modulate the frequency of a voltage controlled oscillator (VCO). This has a triangular output waveform, which is fed to a lowpass filter and limiter to produce an almost sinusoidal waveform of constant amplitude. The advantage of using sinusoidal carrier waveforms is that there are no harmonics that could cause interference between the two channels. The two modulated carriers are finally fed to the output stage where they are mixed, amplified and used to drive an array of infra-red LEDs. The number and positioning of the LEDs depends on the size, shape and furnishings of the room in which the infra-red headphones are to be used, as will be discussed later.

Complete circuit

Figure 2 is the complete circuit of the infra-red stereo transmitter. As previously stated the two channels are identical, except for components that determine the centre frequencies of the

Specification

Modulation method:	FM
Carrier frequencies,	
left channel:	95 kHz
right channel:	250 kHz
Pre-emphasis:	50 μ s
Frequency deviation:	± 35 kHz/volt
Maximum deviation:	± 50 kHz
Audio bandwidth:	20 Hz . 20 kHz

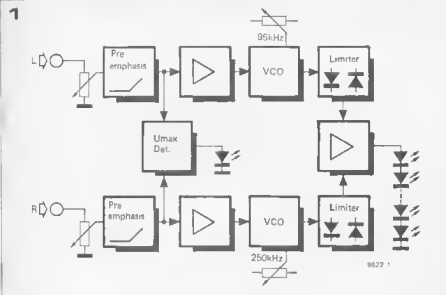
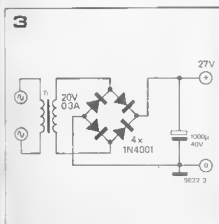
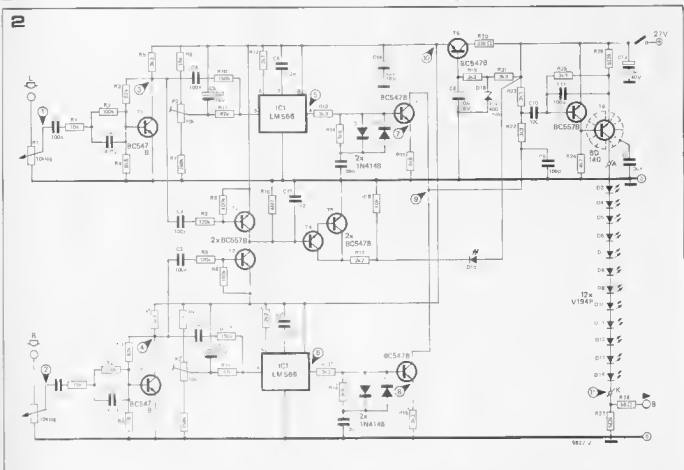

Figure 1. Block diagram of the infra-red stereo transmitter.

Figure 2. Complete circuit of the infra-red stereo transmitter.

Figure 3. An unregulated power supply to provide the 27 V rail for the transmitter.



VCO's. The overload detector comprises transistors T2, T2', T4, T5 and LED D15. The LED glows dimly as soon as the transmitter is switched on, but will glow brightly in the event of an overload. For the VCOs an LM 566 IC was chosen. This has the advantage of a highly linear (typically 0.2%) voltage/frequency characteristic, so distortion of the modulated signal is low. The voltage/frequency conversion ratio of the IC is also very high. The carrier frequency of the left channel can be adjusted to 95 kHz using P2, and similarly the carrier frequency of the right channel can be adjusted to 250 kHz using P2'. The frequency-modulated output of IC1

is filtered, and limited to about 0.7 V p-p by D1 and D2. The 95 kHz and 250 kHz signals at the collectors of T3 and T3' are summed and used to drive the output stage T7 and T8. Further filtering of the signals is provided by C9 and C11. T8 operates as a current source, and a standing current of approximately 125 mA flows down the chain of infra-red LEDs. Point B may be used as a test point or as an output to drive additional infra-red output stages. A simple supply regulator constructed around T6 provides a stabilised 11 V rail for the small signal sections of the circuit, while the output stage derives its power direct from the unregulated 27 V

4

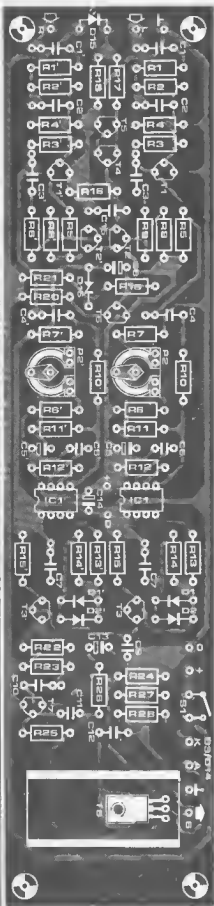

5

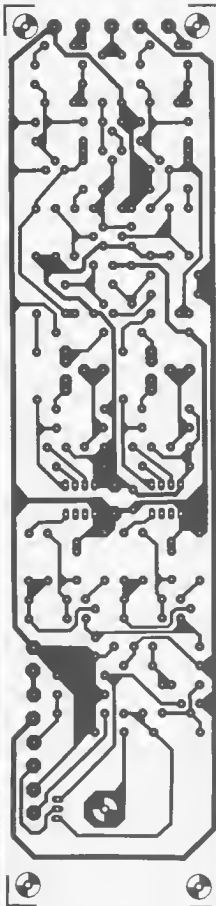

Table 1.

Test point	AF voltage (1000 Hz) [V RMS]	HF voltage [V pp]	DC voltage [V]
1/2	1.6	—	—
3/4	0.95	—	8
5	—	2.3	4.5
		(95 ± 50 kHz)	
6	—	2.3	4.5
		(250 ± 50 kHz)	
7/8	—	1	4
9	—	1.3	15
10	—	—	11
11	—	1	0.7

Current consumption: 155 mA

The above values are approximate, and may vary by 10%.

Parts list.

Resistors:

- R1, R1', R6, R6' = 15 k
 R2, R2', R8, R8' = 100 k
 R3, R3' = 82 k
 R4, R4', R15 = 6k8
 R5, R5', R13, R13', R15', R19, R21, R22, R23, R25 = 3k3
 R7 = 390 k
 R7' = 150 k
 R9, R9' = 120 k
 R10, R10' = 150 k
 R11, R11' = 47 k
 R12 = 2k7
 R12' = 2k2
 R14, R14' = 3k9
 R16 = 4M7
 R17 = 2k2
 R18 = 10 k
 R20 = 330 Ω
 R24 = 4k7
 R26, R27 = 5Ω6
 R28 = 56 Ω
 P1, P1' = potentiometer 10 k (log. stereo)
 P2, P2' = 10 k preset

Capacitors:

- C1, C1', C3, C3', C4, C4', C7, C7', C10, C12 = 100 n
 C2, C2', C6, C6' = 470 p
 C5, C5', C14 = 2μ/16 V tantalum
 C8 = 10 μ/16 V tantalum
 C9, C11 = 100 p
 C13 = 1 μ/40 V

Semiconductors:

- T1, T1', T3, T3', T4, T8, T6 = 8C5478
 T2, T2', T7 = 8C5578
 T8 = 8D140
 D1, D1', D2, D2' = 1N4148
 D3... D14 = 12 x V194P or 12x LD 241 or 2x 6-error
 D15 = LED (red)
 D16 = zener diode 12 V/400 mW
 IC1, IC1' = LM 566

Miscellaneous:

- heat sink for T8
 S1 = switch SPST.

slotless model car track (5)

As mentioned in last month's article, although a receiver circuit was given in Part 1 of the series, the design was not optimum as regards reliability and reproducibility, and for this reason the p.c. board was withheld until some design changes had been made.

The modified receiver circuit is given in figure 1, and a number of differences between it and the original circuit are immediately apparent. T1 is no longer connected as a source follower, but as part of an amplifier with negative feedback from T2. The overall gain of these two stages was raised to 29.5 dB, while at the same time the signal-to-noise ratio was improved by 15 dB. Several small changes in the phase-shifter components around the demodulator IC also improved the performance.

It is apparent from the circuit that extensive decoupling of the supply lines to the various stages is employed. The necessity for this becomes obvious when the stability problems posed by the high gain of the receiver (over 100 dB from input to limiter amplifier output) and the compact layout are considered. It is only by careful attention to p.c. board layout and extensive decoupling that unwanted feedback and instability are avoided.

Construction

The printed circuit board and component layout of the receiver are given in figure 2, with the layout shown scaled up linearly by a factor of two for clarity.

Because of the high component packing density the receiver p.c.b. should be assembled in the following order:

1. Mount T1, T2 and IC1 (use no IC holder!).
2. Mount D2 and C1.
3. Mount resistors R1 to R11, one at a time. The resistors must be orientated as shown on the layout, otherwise other components will not fit.
4. Insert and solder the capacitors, following the same procedure as for the resistors, starting with the disc capacitors and finishing with the tantalum types.
5. Finally inductors L1 and L2 may be inserted and soldered.

The infra-red receiver and multiplex decoder are the heart of the car electronics. The servo amplifier and speed controller cannot operate correctly unless the decoder gives a reliable decodable signal, which means that a decodable signal must be available from the receiver, even under adverse reception conditions.

Needless to say, an extremely small soldering iron bit and fine, cored solder must be used when assembling the p.c.b. D1 will not be connected at present, since it will be mounted on the roof of the car.

Multiplex Decoder

The principle of the multiplex decoder was discussed in part 2 of this series. However, at an early stage of the development it was discovered that the inverted multiplex signal (MPX) could be transmitted and processed with less susceptibility to interference than the MPX signal. In addition, circuits were included to 'clean up' the output signal of the receiver so that even a fairly weak and noisy signal could be decoded, thus increasing the effective range of the system. The final circuit is thus slightly more complicated than that published in part 2.

However, since the multiplex encoder is provided with both MPX and MPX outputs, no modifications are necessary at the transmitter end.

Block Diagram

Figure 4 shows a block diagram of the multiplex decoder. The MPX signal from the receiver is first fed to a Schmitt trigger circuit. The hysteresis of the Schmitt trigger ensures that, once the circuit has been set in one state or the other by the MPX signal, it will not be spuriously triggered by noise pulses present on the MPX signal. The cleaned up MPX signal is fed to the counter that carries out the decoding. On the leading edge of the first pulse in the MPX signal output K1 of the counter will go high and will remain high until the leading edge of the next

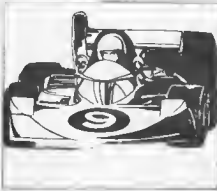

Figure 1. Redesigned circuit of the infra-red receiver, which has higher gain and lower noise figure than the original design.

Figure 2. Printed circuit board and component layout for the receiver. (EPS 9848-1).

Figure 3. Photo of the completed receiver board.

Figure 4. Block diagram of the multiplex decoder, which has been redesigned to incorporate noise suppression.

1

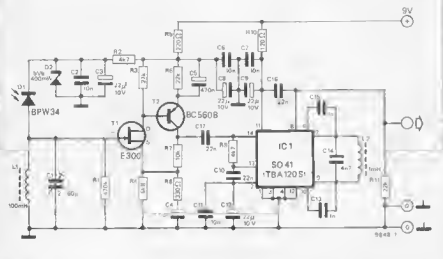

2

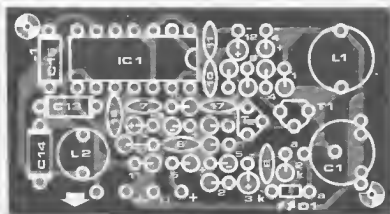

Combined parts list for the infra-red receiver (figures 1 and 2) and the multiplex decoder (figure 5 and 6). The components are numbered consecutively through both circuits.

Resistors (1/8 or 1/16 watt!):

- R1 = 470 k
- R2, R9 = 4k7
- R3 = 27 k
- R4, R17 = 6k8
- R5 = 220 Ω
- R6, R11 = 22 k
- R7, R16, R19, R21 = 10 k
- R8 = 330 Ω
- R10 = 120 Ω
- R12 = 1 k
- R13, R20 = 47 k
- R14 = 100 k
- R16 = 3M3
- R18 = 2k2
- R22, R23 = 100 Ω
- P1 = 10 k preset

Capacitors:

- C1 = trimmer 2...60 p
- C2, C6, C7, C11, C23, C24 = 10 n ceramic disc
- C3, C8, C9, C12, C20, C26 = 22 μ /10 V tantalum
- C4, C5 = 470 n/10 V tantalum
- C10, C16, C17, C19, C21, C25 = 22 n ceramic disc
- C13, C15 = 1 n MKM
- C14 = 4n7 MKM
- C18 = 2 μ /10 V tantalum
- C22 = 1 μ /10 V tantalum

Semiconductors:

- T1 = E 300
- T2 = BC 560 B, BC 559 C
- T3 = 8C 516
- T4, T5 = BC 549 C
- T6, T7 = BC 557 B
- IC1 = TBA1205 or (preferably) SO41P
- IC2 = CD 4017
- D1 = infra-red receiving diode BPW 34
- D2 = zener 5.6 volt /400 mW
- D3 = 1N4148
- D4 = AA 118 (not DUGS!)

Inductors:

- L1 = 100 mH
- L2 = 1 mH

3

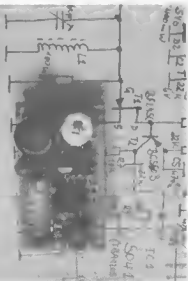

4

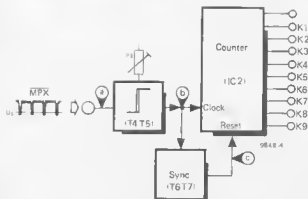

5

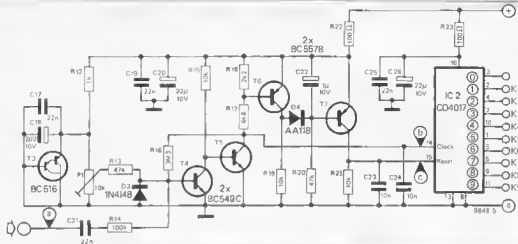

pulse, when output K2 will go high and so on. The time for which each output remains high is, of course, determined by the width of the appropriate pulse, which in turn is determined by the position of the control joystick.

Synchronisation between the encoded signal and the decoder is achieved by circuitry that senses the gap at the end of each train of pulses. During this gap the MPX signal goes high for several milliseconds and this is sensed by the sync circuit, which resets the counter to ensure that it starts from zero at the beginning of the next burst of pulses.

Complete Circuit

Figure 5 is the complete circuit of the multiplex decoder. The signal from the receiver is fed via C21 and R14 into the base of T4, which with T5 forms the Schmitt trigger. The base-emitter junctions of the Darlington transistor T3 are used to provide a reference voltage of about 1.3 V, which is applied to P1. By adjusting P1 a preset DC bias may be applied to the base of T4, which determines the trigger threshold of the Schmitt trigger.

When the MPX signal exceeds the trigger threshold T4 will turn on and T5 will turn off. Positive feedback via R16 will cause T4 to turn on even harder, and will lower the trigger threshold. When the MPX signal falls below the (new) trigger threshold T4 will turn off and T5 will turn on, and the trigger threshold will be restored to its original value. Since the trigger threshold is raised when the input signal is low, and lowered when the input signal is high, the noise immunity of the circuit is greater than would be the case in a circuit with a fixed threshold, without hysteresis.

The cleaned up MPX signal from the collector of T5 is used to clock the counter IC2. It also triggers a monostable multivibrator comprising T6 and T7. So long as the MPX signal is present T6 is continually turned on and off by the MPX signal from the collector of T5, so C22 is discharged through T6 and D4, and T7 is turned off. However, if a pause greater than 4.5 ms occurs in the MPX signal (MPX remains high) then T4 will remain turned on, T5 will turn off

6

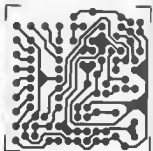
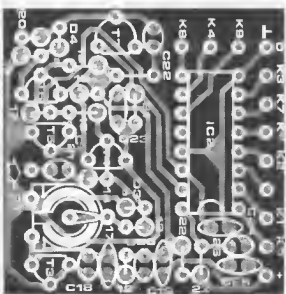

and T6 will turn off, allowing C22 to charge through R20. T7 will thus turn on and pull the reset input of IC2 high, resetting the counter. This can, of course, occur only during the pause at the end of a pulse train.

Construction of the Decoder

A printed circuit board and component layout for the decoder are shown in figure 6. The same method of construction should be employed as for the receiver, with great care being taken to ensure that the vertically mounted components are the correct way round. Although the decoder is provided with nine outputs, only two of these are utilised in each car for the controlling of steering and speed. Thus, car number one uses outputs K1 and K2 of its decoder, car number two uses outputs K3 and K4, and so on.

A photograph of the completed multiplex decoder is given in figure 7, and figure 8 shows an interesting comparison between a prototype receiver (top) and the final versions of the receiver and multiplex decoder (below). The compactness of the final layouts can be

judged from the fact that the two receiver boards shown in the foreground of the photo occupy just over half the area of one prototype receiver!

Test Results

Tests were carried out on the receiver and multiplex decoder, with the receiver photodiode mounted 5 m away from the transmitter array. The photosensitive area of the receiver diode was angled at about 45° away from the transmitter so that only indirect illumination was received.

The upper trace of figure 9 shows the demodulated output of the receiver, which is obviously quite noisy. However, at the output of the decoder Schmitt trigger (lower trace), the signal is clean. Figure 10 shows two similar traces, but in this case only four control channels were being transmitted, a possibility mentioned in the discussion of the multiplex encoder circuit. This modification can be implemented if a maximum of only two cars is to be controlled, and considerably simplifies and reduces the cost of the multiplex encoder.

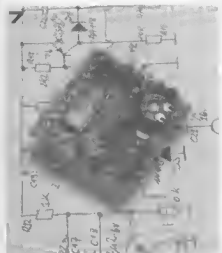

Figure 5. Complete circuit of the multiplex decoder.

Figure 6. Printed circuit board and component layout for the multiplex decoder (EPS 9848-2).

Figure 7. Photo of the completed decoder board.

Figure 8. The degree of miniaturisation of the p.c. boards can be seen from this photo, which shows a multiplex decoder and two receivers compared to a prototype receiver board.

Figure 9. This oscillogram shows how the MPX signal is recovered, even from a noisy received signal.

Figure 10. The inclusion of C23 and C24 allows an even noisier signal to be processed. In this case only a four-channel signal was being used.

Figure 11a. The reset pulse (lower trace) is clearly illustrated here. This measurement was taken using a decoder without filtering, as can be seen from the steep edges of the waveforms.

Figure 11b. Another photo of the MPX signal and reset pulse. In this case the filter capacitors were included, and the slower edges of the waveforms are clearly visible. The inclusion of C23 and C24 makes the decoder much less susceptible to interference.

Figure 12. This four-channel (two car) version of the multiplex encoder and transmitter was used to obtain figures 10 and 11b. The control joystick (foreground) plugs into a DIN socket on the front panel. The infra-red LED array is also visible.



Figures 11a and 11b show the reset pulse, which occurs approximately 4.5 ms after the end of the MPX signal. Apart from the number of pulses in the MPX signal, there is an interesting difference between figures 11a and 11b. The leading and trailing edges of the pulses in figure 11b are much slower than those in figure 11a. This is due to the inclusion of capacitors C23 and C24 in the multiplex decoder circuit, which reduce the sensitivity of the decoder to interference pulses.

Transmitter Modifications

Figure 12 shows a suggested housing for the infra-red transmitter and encoder, one of several prototypes that have been built. The circuitry is mounted inside the case, while the control joysticks are mounted in small plastic boxes and connected using five-core cable and five-pin DIN connectors. The LEDs are mounted on the front panel of the case. If this is metal then the LEDs must be set in a strip of acrylic plastic or other insulating material, since the cases of the LEDs must be isolated from one another. As

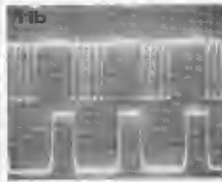
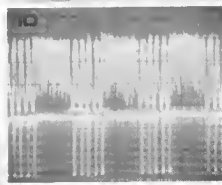
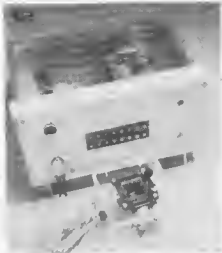

is apparent from the fact that only two DIN sockets are provided, this transmitter unit is a two-car version. In the course of the development several minor modifications were incorporated into the transmitter circuit to increase the range. However, as these consist mainly of removing components, no extra cost is involved. These modifications are detailed below.

1. In order to transmit the MPX signal, the value of R1 must be reduced to 8k2, thus altering the range of the VCO adjustment pot P1.
2. The performance of the transmitter can be improved by connecting T6 and T7, not as current sources, but as switches. This entails removing D5 to D8 and replacing R12 and R13 by wire links. However, 6Ω 8 0.5 W resistors must then be included between points A and B as current limiters. These changes are shown in the modified transmitter circuit of figure 13.

A point that must be noted when using the transmitter is, that if the transmitter is switched off for any reason it should not be switched on again for

16

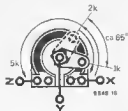

17

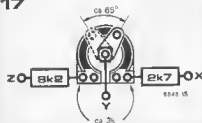

18

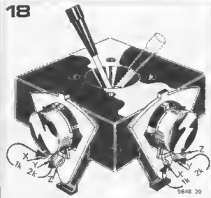

several seconds. This is to allow C1 to discharge completely, as the VCO may not start reliably if C1 has only partially discharged before re-energising the transmitter.

The interconnections between the multiplex encoder and transmitter are shown in figure 14. The only circuit required to complete the transmitter unit is a power supply, which will be described next month. The interconnections between the various sections of the car electronics are given in figure 15. Further details will be given when the construction of the car is discussed in next month's article.

Control Joysticks

The choice of control joysticks for the multiplex encoder may require some clarification. The type of joystick most commonly available uses two standard 5 k potentiometers with a total angular travel of 270°. However, when these are fitted to a joystick control the angle of travel is limited to around 55°-65° (depending on the make of joystick). This corresponds to one-fifth of the total resistance, or about 1 k.

In the multiplex encoder design account is taken of the 'end resistance' of these pots, and the only precaution necessary is to rotate the pots in their mountings (some units have an adjuster for this purpose) until the two end positions of the joystick correspond to resistance values of 1 k and 2 k respectively, measured between points X and Y. This is illustrated in figures 16 and 18. To

19

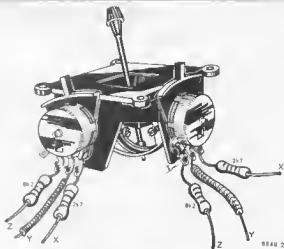

Figure 13. Some slight modifications are made to the transmitter circuit to allow the MPX signal to be transmitted, and also to improve the efficiency of the transmitter. This figure shows the modified circuit, and the changes are detailed in the text.

Figure 14. Showing the connections between the multiplex encoder and the transmitter. The joystick controls are, of course, wired into the appropriate points on the encoder board, either by flying leads or using five pin DIN plugs and sockets. The transmitter power supply will be given next month.

Figure 15. Interconnections between the various units of the car electronics. Constructional details of the car will be given next month.

Figure 16. If the joystick control is fitted with standard 5 k pots then it can be connected directly into the encoder circuit. The pots are adjusted so that the total travel of the stick gives a resistance variation of from 1 k to 2 k approximately.

Figure 17. Some joysticks are fitted with special pots which have a resistance track only over the operating range of the joystick. In this case end resistors must be included and the encoder circuit may require modification.

Figure 18. To set up a joystick fitted with 5 k pots, an ohmmeter is connected between points X and Y and the body of the pot is rotated (using the adjuster if fitted) until the full travel of the stick causes the resistance to vary from 1 k to 2 k approximately.

Figure 19. Joysticks fitted with special pots require resistors in series with the end terminals.

Figure 20. Showing the connections to three types of potentiometer:

- standard 5 k
- special 1 k
- special 3 k.

20

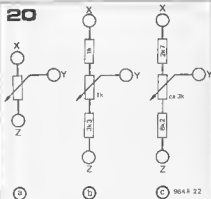

put it another way, the pot is not positioned so that the slider is central when the joystick is central, but is offset so that the end resistance between the slider and point X is 1 k and between the slider and point Z is 3 k.

The other type of joystick which is available is fitted with pots that only have a resistive track over the useful 55 or 65° of travel. The resistance variation between the two extremes of the joystick travel is thus equal to the total resistance of the pot, i.e. there is no end resistance. These joysticks are generally supplied fitted with pots of either 1 k or 3 k resistance. If 1 k pots are fitted then the resistance variation obtainable is the same as with the 5 k standard pot, and all that is necessary is to add 1 k and 3k 'end resistances' as shown in figure 20b, to make the total resistance up to 5 k.

If 3 k pots are fitted then end resistors of 2k7 and 8k2 are fitted (figure 20c) which makes the resistance variation one-fifth of the total resistance, as in the previous two examples. However, since the total resistance is now 13k9, some component values in the multiplex encoder circuit must be altered to allow the circuit to function correctly. Presets P11...P9 are increased to 250 k, capacitors C1...C11 are reduced to 330 p and C27...C35 are reduced to 33 n. Furthermore, C39 is increased to 1 μ (Tantalum bead, '-' connected to R35 and '+' to R31); R31 is increased to 18 k.

biorhythm calendar

As discussed elsewhere in this issue, biorhythm theory proposes that there are three dominant biological cycles, the physical, the emotional and the intellectual, which together determine how a person feels at any given time. These cycles can be represented as sinewaves, each with a different period (23, 28 and 33 days respectively), and since they are all assumed to have started at the moment of birth, it is possible to calculate the 'time' of ones bioclock on any given day, past, present or future. The amplitude of the waveforms indicates the intensity of the condition represented by the curve, a positive portion of the curve being regarded as a favourable influence and vice versa. The day on which a curve intersects the zero-crossing point is reckoned to be particularly critical.

The following four circuits are intended to give a continuous indication of a person's biorhythmic condition by charting the progress of each cycle.

16½-counter

The circuit shown in figure 1 is essentially a 16½-counter designed to indicate the state of the intelligence cycle. The circuit displays the number of days that have elapsed in the current half-period of the biorhythm cycle, preceded by a '+' or '-' sign during the positive or negative half-cycle respectively.

The operation can be summarised briefly as follows. A symmetrical square-wave with a period of 24 hours (from a digital clock, for instance) is connected to one input pin of N13. This signal is passed through N13 and N12 (these gates will be discussed further on) to the count input of a counter (IC2). The first 9 days of the half-period are counted in the normal way and the output of IC2 is decoded by IC1 to drive the right-hand display. At the start of the 10th day the output of IC2 goes to '0' (more accurately, the four BCD-coded outputs A, B, C and D all go to '0') and the negative-going pulse at the D-output clocks FF2. The Q-output of FF2 is passed through N4 to produce a '1' indication on the left-hand display, so that the following days are displayed as '10', '11', '12', etc. So far so good. At the end of the 16th day, things start

The 'Biorhythm' theory offers an explanation for the occurrence of emotional 'ups' and 'downs'.

This article offers a TTL circuit for calculating and displaying the Biocycles . . .

to happen. Since a 16½-day cycle is required, the counter will have to be reset to '1' halfway through the following (i.e. 17th) day. Furthermore, since this transition is considered 'critical', some indication that we are into the 17th day is required. At this point in time, the circuit functions as follows. The outputs of IC2 and FF2 corresponding to a count of 17 are decoded by gates N2, N3 and N8. The output of N8 goes to logic '0', the output of N7 goes to '1', N6 is enabled and passes a low-frequency square-wave signal to the blanking input of IC1 and to one input of N4. The result is that the display starts to flash on and off, indicating that a 'critical day' is in progress.

Going back now to N8: when its output goes from '1' to '0', FF3 is clocked. The Q-output from this flip-flop is fed to one input of the EXOR N12. The result is that the function of N12 is changed: as long as the Q-output of FF3 was '1', N12 operated as an inverter for the input signal; however, when the Q-output becomes '0' N12 starts to operate as a non-inverting buffer. Since the clock input of IC2 reacts to a negative-going input signal, and since a symmetrical square-wave is present at the input of the circuit, the net result is that the time of day at which IC2 will be clocked is shifted over 12 hours. In other words, if the transition from 16th to 17th day occurred at 3 a.m., say, the transition from 17th to 1st day will occur at 3 p.m. This 12-hour shift will be maintained until FF3 is once again clocked at the end of the following half-period.

While we are in this corner of the circuit, we can take a closer look at N9, N10 and FF4. We had already discovered that the output of N8 was used (among other things) to produce a flashing display during the first half of the 'critical day'. FF4 is included to prolong this indication through the first half day of the new period. To achieve this, the flip-flop is clocked in antiphase with respect to the main counter, i.e. halfway through each day. The output of N9 is high during the first half of the 17th day, so the clock pulse at the end of this period causes the output of

Figure 1. Circuit diagram of the 16½-day counter.

Figure 2. The 11½-day counter circuit.



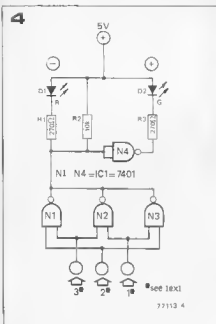

Figure 3. Circuit for the 14-day counter.

Figure 4. The 'overall influence' decoder.

The cycles start on the positive-going half-period, so the 18th day in the 28-day cycle, for instance, must be displayed as '- 4'. A further complication exists in that the 1½-day and 16½-day counters should run 12 hours out of step with the 14-day counter during their negative half-periods. If this is not the case initially, the counters should be advanced until they all run in synchronism when pulses are fed into the common clock input. Any '-' signs in the display can then be converted into '+' signs by briefly shorting the 'clear' input (pin 2) of FF1 in the corresponding counter to ground.

Absolute accuracy is only possible, of course, if the positive-going transition of the incoming clock signal corresponds to the hour of birth. Such a signal will not normally be readily available in a digital clock that is displaying the correct time . . . This problem can be solved by using the 'Alarm' described in Elektor 9, page 135: this is switched to the '24-hour' mode and the '12-hour' output (pin 4 of IC4) is used to drive the biorhythm counters. As a final note, it seems only fair to point out that pocket calculators are available, at quite reasonable cost, that have a built-in biorhythm program . . .

The state of the weather affects not only a person's psychological well-being, but also physical health. It has long been known that such basic factors as temperature, humidity and atmospheric pressure can have a profound effect upon physical well-being, but in recent years much attention has been given to the effect of ions present in the atmosphere.

Ions are positively or negatively charged molecules of the gases that make up the atmosphere, and their concentration depends on location and the prevailing weather conditions. It is believed that a preponderance of negative ions has a positive effect on physical well-being, while a preponderance of positive ions has a negative effect. The average concentration of ions of either polarity is normally fairly small, around 400 to 1500 ions per cc. of air, but in mountain resorts such as St. Moritz the concentration of negative ions is considerably higher, which may account in part for the salutiferous effect of such resorts. In contrast, the oppressive atmosphere that precedes the onset of a thunderstorm is associated with the approach of a front containing an excess of positive ions.

Scientists who have researched the effects of differing ion concentrations and polarities have claimed that an excess of negative ions can counteract such complaints as insomnia, irritability and being generally tired and run-down. One explanation that has been put forward for the effect is that negative ions have a beneficial effect on cell metabolism.

It would certainly appear that there is some truth in these claims, as ionisers that artificially increase the proportion of negative ions in the air are becoming quite popular. Readers can experiment for themselves by building the simple ioniser circuit shown in figure 1. This consists of a 27-stage voltage multiplier that steps up the 240 V mains to a DC voltage of approximately 7.5 kV. The negative output terminal of the multiplier is connected to an ordinary sewing needle. As many readers will be aware the electric field strength around a charged body is greatest where the curvature is greatest, i.e. around sharp

ioniser

The ioniser produces a high concentration of negative ions in the surrounding atmosphere, which many people find stimulating and refreshing.



2

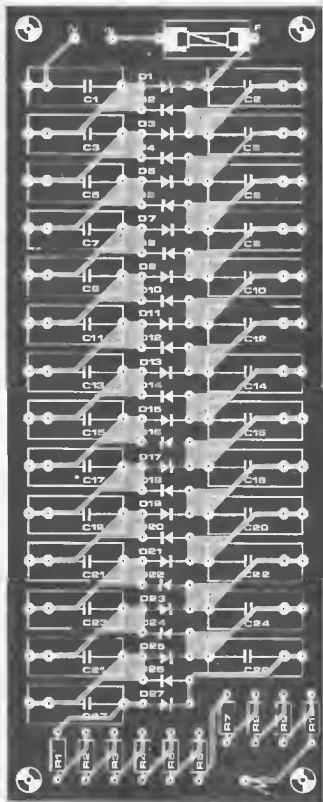
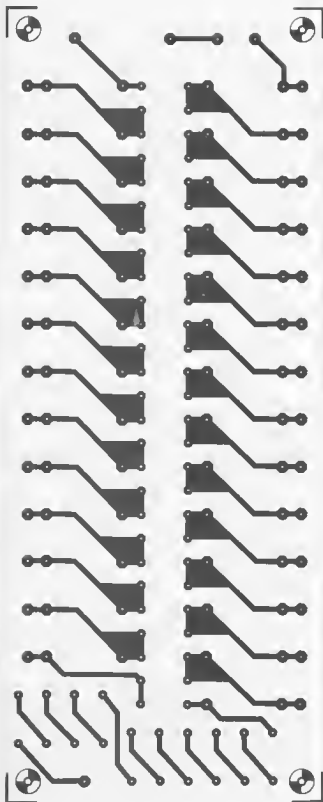

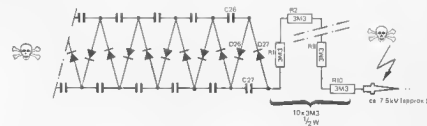
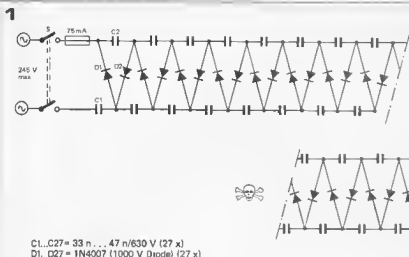

Figure 1. Circuit of the ioniser. The resistors in series with the discharge needle limit the current to about 220 μ A if the needle is accidentally touched.

Figure 2. Printed circuit board and component layout of the ioniser.

Parts list to figure 2.

Diodes:

D1 ... D27 = 1N4007 or similar 1000 V diode.

Resistors:

R1 ... R10 = 3M3 / 1/2 watt

Capacitors:

C1 ... C27 = 33 n or 47 n, 630 V

points. An intense field is thus present at the tip of the needle, and electrons from the tip of the needle are 'sprayed' onto the surrounding air molecules, turning them into negative ions. These ions are then repelled by the negative charge on the needle point, and other air molecules take their place and are ionised in turn, which means that a constant 'wind' of negative ions emanates from the needle point.

As the needle must be exposed to the air in order to generate the ion stream it is necessary to limit the current that can flow in the event of the needle being inadvertently touched, and this is the function of resistors R1 to R10. *Under no circumstances should these resistors be omitted or bypassed, as this could result in a fatal electric shock.*

Construction

A printed circuit board and component layout for the ioniser are given in figure 2. Assembly of the board requires little comment except to note that there should be no protruding wires or spikes of solder on the back of the board, especially towards the high-voltage end of the multiplier, as this could result in unwanted discharges. All joints should be smooth and neat.

When mounting the ioniser in a box the accent must be on safety. The p.c. board should be mounted on insulated spacers in an insulated box. The needle can be mounted through the side of the box (point outwards of course) and to prevent accidents it should be surrounded by a short length of 25 mm or 50 mm plastic pipe mounted coaxially with the needle. The connection between the needle and the output of the voltage multiplier should be made as short and as rigid as possible, so that in the event of the wire breaking there is no chance of it touching any other part of the voltage multiplier circuit.

After a period of use the needle point will become dirty and eroded, so it is a good idea to make the needle removable for cleaning and replacement.

Using the Ioniser

The ioniser can be tested by placing a wet finger a few cm from the needle to feel the ion 'wind'. In use the ioniser should be mounted in such a position that the ion stream is not obstructed by any objects in the room, as otherwise the object would acquire a large negative charge.

It is wise not to remain in the immediate vicinity of the ioniser nozzle for too long since, in addition to ionising the air, the ioniser also produces ozone (triatomic oxygen, O₃). This is highly reactive and if breathed in large quantities can cause irritation of the respiratory system, and for this reason the ioniser is not recommended for use in the vicinity of asthma sufferers. For safety reasons it is also not recommended to use the ioniser in humid conditions such as in the bathroom or kitchen.

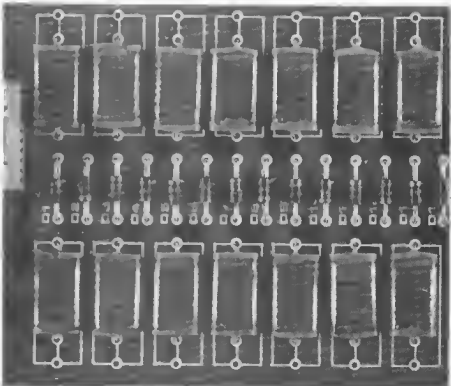

touch contacts

A touch contact is simply a pair of electrodes that can be bridged by a finger, the circuit being completed by skin resistance. It is possible to make touch contacts by etching a suitable pattern on copper laminate board. These can look very attractive, especially if nickel or chromium plated, but they have the disadvantage that the insulating area between the contacts is easily bridged by dirt and moisture, thus forming a permanent conducting path and causing the touch switch to 'stick' in one position. This type of contact invariably requires frequent cleaning.

In a good design of touch contact the insulator between the two electrodes should be recessed so that it cannot be touched. This delays the ingress of dirt and moisture, which means less frequent cleaning.

Touch contact using upholstery tacks

A simple yet effective touch contact can be made using a pair of chrome plated upholstery tacks, as shown in figure 1. These are mounted on an insulating panel with their edges a few millimetres apart. If required an LED may be mounted between them, connected to the output of the touch switch so that it lights when the contact is touched.

Concentric touch contact

A contact in which the inner and outer electrodes are concentric may be constructed using an upholstery tack and a cup washer, as shown in figure 2a. To secure the cup washer to the (insulating) panel and to make contact to it, two panel pins are soldered to the back of the cup washer, and are then pushed through previously drilled holes in the panel. A fibre washer mounted in the centre of the cup washer insulates it from the upholstery tack, which is pushed through a third hole in the panel, located at the centre of the cup washer. The tack and cup washer can both be fixed to the panel using epoxy adhesive. A variation on this theme is to use an eyelet for the centre contact, as shown in figure 2b. This allows an LED indi-

Various circuits for touch switches have been published in Elektor, and many readers have asked for constructional details of touch contacts to use with them. Still other readers have submitted suggestions for such contacts, and several of these are presented here to provide food for thought.

Based on suggestions by
A. Bosschaert, A. de Weerd,
B. Lahn, H. Onghena and
M. Keul.



cator to be mounted in the centre of the eyelet. In this example a screw has been used to make contact to the cup washer and to secure it to the panel.

Touch contact using LED indicator

The final type of touch contact to be described has the most attractive appearance, but is also the most difficult to construct (figure 3). The contact is based on an indicator of the type consisting of an LED in a metal bezel. The outer electrode of the contact is simply the raised flange of the metal housing which, when mounted on a (grounded) metal panel will form the earth contact.

The tricky part of the operation is to make the centre contact. To do this the LED must be removed from the housing and a small hole drilled down each side. A loop of tinned or silver plated wire is then inserted to form the centre contact. For obvious reasons, this type of contact should be attempted only if suitable equipment, such as a high-speed miniature drill, stand and vice is available. Equally obviously, the drilling procedure should be attempted only on the larger types of LED. After some practice a fairly high success rate (greater than 50%) can be achieved.

A slightly different approach, which is less likely to damage the LED, may also be employed. For this it is necessary to use an indicator fitted with a large (c. 5 mm) LED. This is removed and replaced by a 3 mm LED. The wire loop for the centre contact can then be glued down the sides of the LED, and a piece of plastic sleeving popped over the whole assembly to insulate the loop from the metal housing. The 3 mm LED plus wire plus sleeving should then be a snug fit in the 5 mm hole in the metal housing.

Test Circuit

A simple test circuit (and a practical touch switch) is given in figure 4. It consists of a set-reset flip-flop using two inverters (part of a CMOS IC type 4069). When contact 1 is touched, that input is pulled low and the Q output goes high, which takes input 2 high and causes Q

1

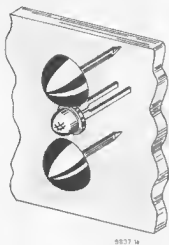

9837 1a

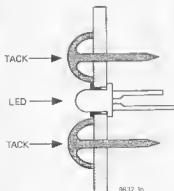

9837 1b

2



9837 2a

9837 2b

2

3

4

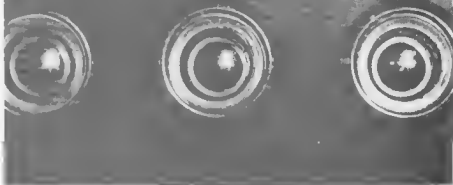

Figure 1. Simple touch contact using two up holstery tacks. If required an LED may be mounted between them.

Figure 2. Two versions of a concentric touch contact using a cup washer as the outer electrode. If an eyelet is used as the centre contact an LED can be inserted in the centre hole.

Figure 3. Constructional details of a touch contact based on an LED indicator with a metal housing. Extremely careful drilling is necessary to avoid damaging the LED.

Figure 4. Test circuit and practical touch switch using CMOS inverters. Since one IC contains six inverters each IC can be used to make three touch switches.

3



9837 3

4

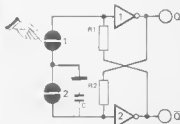

9837 4

output to go low. When contact 2 is touched the reverse happens.

Resistors R1 and R2 may be anywhere between 1 M and 22 M, depending on the required sensitivity of the touch switch. Capacitor C (10 n) may be added if required: its function is to ensure presetting of the circuit in one of the two states at initial switching-on. **M**

formant

the elektor music synthesiser (4)

The two principle requirements of a synthesiser VCO are stability and good tracking. Stability means that if the control voltage applied to the VCO remains constant, then the frequency of the VCO should also remain constant and not drift. Tracking means that the VCO must follow the prescribed logarithmic 1 octave/V characteristic as closely as possible. In particular, where several VCOs are used they should all have similar characteristics.

These parameters are particularly important in a chording instrument such as the Formant, where a number of VCOs are used simultaneously. In a synthesiser using only one VCO slight drift or deviation from the 1 octave/V characteristic might not be noticed, since the ear is not particularly good at judging absolute frequency, unless a person has 'perfect pitch'. In any chording instrument however, even slight mistuning is immediately apparent due to the formation of beat notes.

For example, if two or more VCOs are tuned to the same pitch any slight mistuning is audible as beat notes having a frequency equal to the difference between the two VCO frequencies.

Slight mistuning between VCOs is frequently employed deliberately. If the degree of mistuning is slight the beat frequencies are low and beat notes are not audible, but a pleasing chorus or phasing effect is obtained, especially if several VCOs are used. This imparts a much more lively character to the sound which contrasts with the sterile sound of fixed phase instruments such as electronic organs based on a divider system (see figure 1).

However, if the VCO frequencies drift apart due to poor stability the beat notes quickly become obtrusive and unpleasant, and ultimately a discord is audible. A similar effect can be noted when the tracking of the VCOs is poor. If a chord is set up at a particular pitch then the musical intervals in the chord should be maintained when the chord is transposed to a different pitch. However, if the tracking of the VCOs is poor this will not be the case and a discord will result.

A good test of the VCOs in a synthesiser is thus to tune them together so that no

The voltage controlled oscillators (VCOs) are the heart of any synthesiser. The quality of the VCOs ultimately determines the performance of the synthesiser, and because of the importance of the VCO two articles will be devoted to its design and construction.

C. Chapman

beat notes are audible and check that the tuning is maintained over a period of time and with changes in such parameters as supply voltage, temperature etc. The tuning between the VCOs should also be maintained when the pitch is transposed.

Any VCO which cannot meet these criteria is useless for a synthesiser, and the design of a suitable synthesiser VCO is necessarily quite complex.

Block diagram

The VCO circuit used in the Formant follows the form proposed first by Robert Moog (figure 2). The VCO input stage consists of a summing amplifier into which a number of control voltages may be fed. A potentiometer on its output sets the octaves/volt characteristic of the VCO. The resulting control voltage is fed to an exponential voltage-current converter, the output current of which doubles for every 1 V rise in input voltage. The output of this converter controls a linear current-controlled oscillator, which produces a sawtooth waveform. Finally, a curve shaper connected to the sawtooth output delivers four further waveforms: spaced sawtooth, squarewave, triangle and sinewave.

Oscillator section

The CCO is the heart of the VCO circuit, as explained above.

The CCO section is shown in figure 3. The output of the exponential voltage-current converter that feeds this section is represented by the current source symbol at the bottom left of the diagram. This current is of course varied by the control voltage applied to the exponential converter.

FETs T2 and T3 are connected as source followers; their high input resistance ensures that no significant current is robbed from the current source, even at low currents, as this would spoil the sawtooth linearity and could affect the current-frequency linearity of the CCO. IC1 is a Schmitt trigger that senses when the sawtooth voltage has reached a predetermined level.

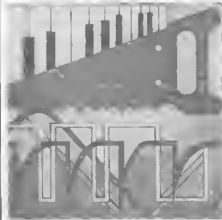

1

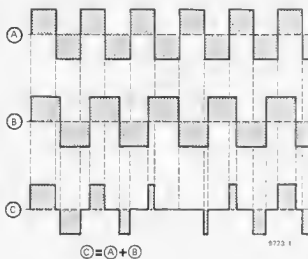
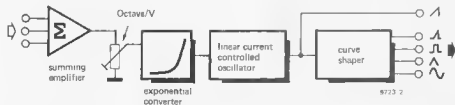

Figure 1. When two notes of almost the same frequency are played together, beat notes are formed which produce a pleasing 'chorus' effect.

Figure 2. Block diagram of the VCO, which comprises an input summing amplifier, exponential voltage-current converter, linear current controlled oscillator and curve shaper circuits.

Figure 3. The linear CCO is the heart of the VCO module. C2 charges linearly to the lower threshold of IC1 before being discharged by T1, thus producing a sawtooth output waveform. The output of the exponential converter, which determines the charging current and hence the CCO frequency, is represented by the current source symbol.

2



3

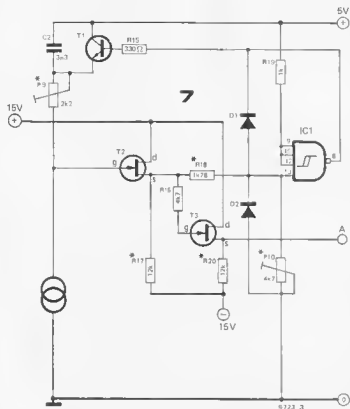

The circuit functions as follows: assume that initially C2 is discharged. The voltage at the gate of T2 will then be nearly +5 V, and since T2 operates as source-follower the voltage at the input of IC1 will be above the positive trigger threshold of this Schmitt trigger, so its output is low and T1 is turned off. As C2 charges from the current source the gate voltage of T2 will fall as the voltage across the capacitor increases. Since C2 is being charged from a constant current source the voltage across it will increase linearly with time, in accordance with the equation

$$UC_2 = \frac{I \cdot t}{C_2}$$

When the voltage at the input of IC1 has fallen below its negative switching threshold the output of IC1 will go high, which will turn on T1 and discharge C2 until the input voltage of IC1 has risen above its positive threshold, when T1 will turn off and the whole cycle will repeat. A detail of the IC1 output and input waveforms during the discharge of C2 is shown in figure 4

FET T3 is simply an output buffer stage. As mentioned earlier, the use of two buffer stages in cascade ensures that any load on the output cannot affect the linearity or frequency stability of the CCO.

The setting of P9 affects the high-frequency linearity of the CCO and is used to set the VCO tracking at high frequencies.

Since N-channel FETs are used for the source-follower buffers, the source voltage is always slightly positive with respect to the gate voltage, so that even when the gate of T2 is at zero volts there is always a slight positive voltage on the source. If the source of T2 were connected direct to the input of IC1 it would be possible that the source voltage of T2 (minimum, depending on FET tolerances, typically 1 V) might never fall below the negative threshold of IC1 (typically 0.85 V). For this reason T2 is connected to the input of IC1 via a potential divider comprising R18 and P10, the latter being adjusted to ensure that the oscillator starts reliably.

The exponential converter

The exponential voltage-current converter doubles the output current fed to the CCO, and hence the CCO frequency, for every 1 V increase in control voltage.

In common with most such circuits, the exponential converter makes use of the (exponential) collector current versus base-emitter voltage characteristic of a bipolar transistor. Every transistor exhibits this exponential relationship, but not all transistors are suitable for use in exponentiator circuits. The reason is that collector leakage current can cause a deviation from the characteristic at low collector currents, and transistor base resistance can cause a deviation at high collector currents.

Special transistors for such applications are available, but even these have their limitations due to temperature dependence of the collector current. At around room temperature, collector current doubles for a V_{be} increase of around 17 mV. However, a temperature increase of around 10°C will also double the collector current, so it is apparent that, unless some form of temperature compensation is employed, even small temperature changes will cause noticeable variations in the pitch of the VCO.

There are two methods of reducing the influence of changes in (ambient) temperature, both of which are used in the Formant VCO. The first of these is to use a matched pair of transistors in the exponential converter, one of which is used for temperature compensation. The second method is to keep the chip temperature of the transistors constant. By employing both methods absolute accuracy and stability of the exponential converter are achieved. Temperature stabilisation of the chip may sound like a complicated business, but fortunately a purpose-built IC is available, the $\mu A726$. It consists of two matched NPN transistors and also contains a temperature control circuit that maintains a constant chip temperature.

The circuit of the exponential converter is given in figure 6. IC4 is not strictly

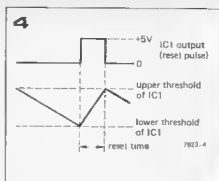

Figure 4. Detail of the sawtooth waveform and the output of IC4 at the reset point where T1 is turned on.

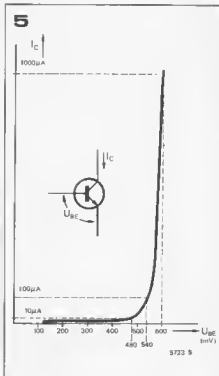
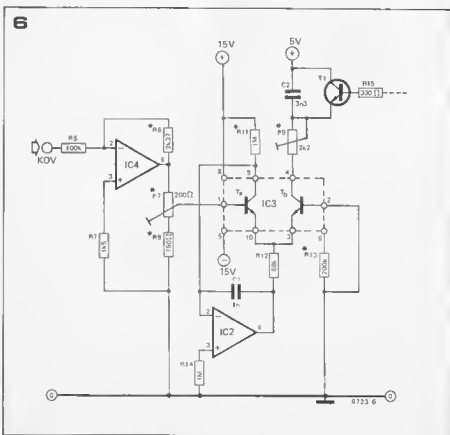

Figure 5. The exponential relationship between base-emitter voltage and collector current of a bipolar transistor is exploited in the exponential generator.

Figure 6. Circuit of the exponential voltage-current converter, which is both temperature stabilised and compensated. IC4 and T1 are respectively parts of the input adder circuit and the CCO.

Figure 7. Complete circuit of the input adder. This will sum input control voltages from the keyboard or ECV socket, DC offset voltages for chording, and AC input signals for frequency modulation of the VCO.

Figures 8 and 9. The musical quality of a waveform depends on the harmonic content. The harmonic structure of two well-known waveforms is shown: sawtooth (figure 8) and squarerwave (figure 9). In order to obtain the widest range of sounds from the Formant VCO, curve shaper circuits are provided that produce four waveforms in addition to the basic sawtooth.



7

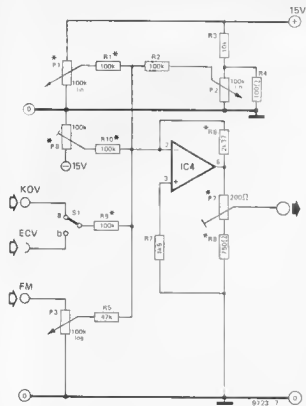

8

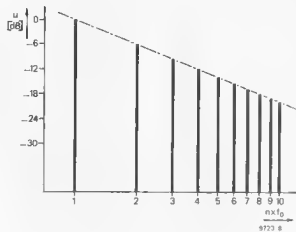

9

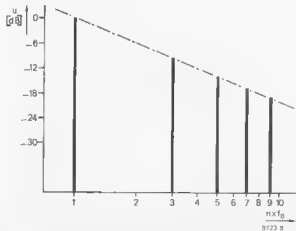

part of the converter but is part of the summing amplifier section. At the operating temperature of the 726 a V_{be} increase of between 19 and 23 mV is required for each doubling of collector current, so the 1 V/octave output of the keyboard must be attenuated.

IC4 is connected as an inverting amplifier with a gain of 0.0237. Since the KOV input is always positive the output of IC4 will always be negative, and will give an output of -23.7 mV per volt input. P7 allows the input voltage to the exponential converter to be varied between -18.7 and 23.7 mV per volt input, in order to compensate for tolerances in IC3.

The exponential converter proper comprises IC2 and IC3. The non-inverting input of IC2 is grounded through R14, so the inverting input should also be at (virtual) earth potential. For this to be the case, a constant current of $15 \mu\text{A}$ must flow through R11, i.e. the collector current of T_A must be constant at $15 \mu\text{A}$. The voltage-to-current conversion can now be explained as follows.

If the input voltage KOV is increased by 1 V then the base voltage of T_A will fall by around 20 mV (depending on the setting of P7). Since the collector current of T_A cannot decrease the output voltage of IC2 must fall in order to reduce the emitter voltage of T_A by 20 mV, maintaining the same base-emitter voltage and thus the same collector current. As the base of T_B is grounded this means that the base-20 mV, and the collector current of T_B will double. The collector of T_B is connected to P9 in the CCO circuit, as shown in the top right corner of figure 6.

Summing amplifier

The summing amplifier, part of which was shown in figure 6, is given in its complete form in figure 7. Point KOV is permanently connected to the 1 V/octave output of the keyboard interface receiver, but the input of the summing amplifier can be switched between this point and an external control voltage socket (ECV). Potentiometers P1 and P2 give coarse and fine adjustment of a DC offset voltage to transpose the VCO pitch for setting up chords etc. Preset P8 is also provided as an offset control that compensates for the input offset voltage of IC4, and sets the lowest frequency of the VCO (around 15 Hz).

A frequency modulation (FM) input is provided, which can be fed with external (AC) signals to give vibrato effects etc. The modulation depth can be adjusted by P3, the maximum sensitivity being about 2 octaves/V with P3 turned fully clockwise.

As previously mentioned, the summing amplifier actually has a gain much less than one, so that the output voltage of IC4 is reduced to -23.7 mV per volt input.

Curve shapers

Having ensured that the 'business end' of the VCO design is satisfactory, the design of the curve shaper section — which influences the musical characteristics of the VCO — may now be considered. The main processing of the synthesiser waveforms is done by means of voltage-controlled filters (VCFs) which remove certain frequencies from a harmonically rich waveform.

The spectra of two well-known harmonically rich waveforms are shown in figures 8 and 9 — the sawtooth, which contains all the odd and even harmonics of the fundamental, and the squarewave, which contains only the odd harmonics. However, this approach does have its limitations if only one waveform is provided at the VCO output. Using as an example the two waveforms just mentioned; no amount of filtering will generate the even harmonics necessary to turn a squarewave into a sawtooth, and it would be very difficult to filter out all the even harmonics from a sawtooth to make a squarewave. It is thus obviously useful to have several different waveforms available at the VCO output.

A block diagram of the curve shaper is shown in figure 10. The sawtooth output of the VCO is fed to curve shaper circuits, which produce respectively spaced sawtooth, triangle, sine and square waveforms. The pulse width of the squarewave may be modulated by an external control signal, as will be explained in the description of this part of the circuit.

The five waveforms may be selected by means of switches to be fed, either singly or in combination, into a summing amplifier.

Musical properties of the waveforms

Each of the waveforms available at the VCO output has its own musical character, which is useful for particular applications. An unfiltered squarewave is not particularly useful, since the odd harmonics cause the sound to be extremely harsh. However, filtered squarewaves are useful for the imitation of flute tones, and certain woodwinds such as clarinet.

The sawtooth waveform, which is rich in all harmonics is suitable for the imitation of brass, woodwind and many string instruments, and has an extremely bright and lively character.

The amplitudes of the sawtooth harmonics fall off at 6 dB per octave, i.e. the amplitude of the n th harmonic is $1/n$ times the amplitude of the fundamental. Where this fall is too abrupt the spaced sawtooth waveform can be used. This has an even brighter character than the sawtooth and is extremely useful for imitating very brilliant instruments such as the violin family and some of the higher pitched brass instruments such as cornet and

10

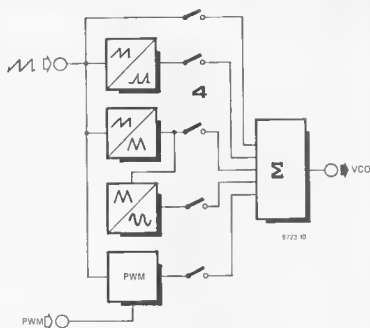

11a

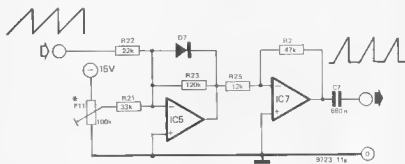

11b



trumpet.

The triangle and sine waveforms are musically very similar. The triangle is completely lacking in even harmonics, and the odd harmonics are of low amplitude. The sound of the triangle is flute-like, very smooth and mellow.

A pure sine waveform is, of course, completely lacking in any harmonic content and sounds even smoother and more bland than the triangle — so far as to be completely without character.

A low harmonic distortion of the sine waveform is not particularly important for musical applications, provided the harmonic content is sufficiently low that the sinewave sound contrasts with that of the triangle. The sinewave is thus derived from the triangle by an extremely simple diode shaper circuit.

Figure 10. Block diagram of the curve shaper. An output adder allows the various waveforms to be fed to the output either individually or in combination.

Figure 11. Circuit of the spaced sawtooth converter. This clips the sawtooth waveform, passing only the peaks.

Figure 12. The triangle converter operates by feeding the positive and negative half-wave rectified sawtooth to the inputs of a differential amplifier. The resultant difference output is a triangle waveform.

Figure 13. The sine converter operates simply by 'rounding off' the peaks and troughs of the triangle to give an approximation to a sinewave.

12

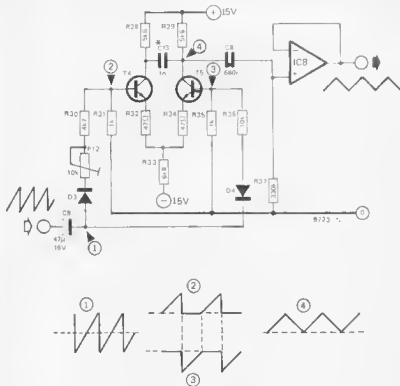

13

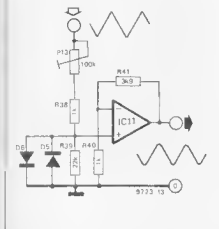

Spaced sawtooth converter

Figure 11a shows the circuit of the spaced sawtooth converter section. The sawtooth output of the VCO is fed into IC5 via R22. IC5 functions as an inverting half-wave rectifier, with a variable offset provided by P11. Depending on the setting of P11, the negative voltage at its slider causes a positive offset at the output of IC5 of between zero and about +14 V.

While the output of IC5 is positive D7 is reverse biased and the op-amp amplifies and inverts the positive going input sawtooth with a gain of about 5.5. However, this applies only so long as the output of IC5 remains positive. As the sawtooth voltage increases, a point on the waveform will be reached where the output of IC5 falls below zero. D7 will

become forward biased and will clamp the output of IC5 to about -0.6 V.

The point on the sawtooth waveform at which clamping occurs depends on the setting of P11. With P11 adjusted to give an offset of zero the sawtooth will be clipped at a very low level. On the other hand, with P11 set to give a large offset voltage the sawtooth amplitude may never be high enough to cause the output of IC5 to swing negative, and the sawtooth will appear at the output of IC5 unclipped.

IC7 amplifies and inverts the output from IC5 with a gain of about 4, and P11 is adjusted so that the amplitude is the same as that of the sawtooth waveform, nominally 1.5 V p-p.

Triangle converter

Half-wave rectification is again employed in the triangle converter, figure 12. The input sawtooth (1) is positive and negative half-wave rectified by D3 and D4, and the positive and negative half cycles are fed to the bases of T4 and T5 respectively (2) and (3). Since T4 and T5 form a differential amplifier the collector waveform of T5 is (2) - (3), which is a triangular waveform (4). IC8 is connected as a voltage follower to buffer the output.

It may seem a little strange to use a discrete amplifier in this circuit when extensive use is made of IC op-amps elsewhere. The reason is that they have a limited slew rate, and this can result in a notch at the apex of the triangular waveform where the crossover from

positive half-cycle to negative half-cycle occurs. This introduces harmonics that detract from the mellow sound of the triangular waveform. The discrete amplifier has a larger slew rate and is largely free from this defect. C13 also helps to filter out the spike, but it does cause a slight falloff of the triangle amplitude at high frequencies. The value of 1 n for C13 is by no means mandatory, and other values may be substituted to suit personal taste.

Sine converter

As mentioned previously, the sine converter does not produce an extremely pure sine wave, but the circuit (figure 13) is simple and the output waveform is musically adequate. The triangle output from IC8 is fed to the non-inverting input of IC11 via P13 and R38. The positive and negative excursions of the triangle at the op-amp input are limited logarithmically by a matched pair of diodes D5 and D6, and the resulting approximation to a sine wave is amplified by IC11.

P13, R38 and R39 form an attenuator. The setting of P13 determines the triangle amplitude that would appear across R39 were D5 and D6 omitted, and hence the point on the triangle waveform at which limiting occurs. For example, with P13 set to maximum the voltage appearing across R39 will be very small, and D5 and D6 may conduct only on the peaks and troughs of the triangle, so the output will be too 'peaky'. On the other hand, with P13 set to minimum the signal will be clipped very early in the waveform. Somewhere between these extremes is a setting of P13 that will give the best approximation to a sine wave. This setting can be found either by ear, or visually using an oscilloscope, or using a distortion meter to adjust for minimum distortion.

Pulse width modulator

This section of the curve shaper generates a square wave whose duty-cycle can be preset to any desired value from 0 to 100%, or which can be modulated by an external signal. T6, T7 and T8 (figure 14) form a high speed voltage comparator whose output will go high when the sawtooth input voltage exceeds the base voltage of T7, and which will go low on the trailing edge of the sawtooth.

The base voltage of T7 is set by the output voltage of summing amplifier IC6, which can be fed both with a DC voltage via P5 and with a signal from the PWM input. As the output voltage of IC6 becomes more positive the comparator will trigger later and later along the sawtooth ramp, so the output pulse will be narrower. This is illustrated in figure 14b, which shows the response to a low-frequency triangular PWM input signal.

introducing microprocessors (2)

Microprocessors are virtually useless on their own. They must be used in combination with some kind of input/output (I/O) unit for communication between 'the machine' and 'the outside world', and some form of 'memory' must also be provided. Memory not only allows data and programme steps to be retrieved at high speed for processing, but also permits the results of operations to be stored, which enables the computer to make subsequent decisions based on those results. Without memory capability none of this would be possible.

In order to gain an understanding of microprocessors, it is therefore essential to know something about microprocessor-type information and memories.

Digitisation

As mentioned in last month's article, information to be processed in a computer system is converted into binary code, or some derivative thereof. As any digit of a binary number has only two possible values — 0 or 1 — it is very easy to represent binary digits in an electronic system, e.g. by the presence or absence of a voltage, a switch being closed or open etc.

Decimal digits, letters and symbols can be represented by a binary code of several BITS (BIT is an abbreviation of binary digit), and an example of this is the well-known ASCII (American Standards Code for Information Interchange) code shown in table 1. Here, all the letters of the alphabet, numerals, punctuation marks and many other symbols are represented as 8-bit binary WORDS. A word is any parallel array of bits. An 8-bit word is generally called a BYTE. The significance of word lengths with respect to memories and microprocessors will be enlarged upon later.

Memories

In a computer system data and programme instructions are stored in a memory. Each cell of a memory can store one bit, and a memory will typically contain several thousand cells. A number of cells in which a word is stored is called a LOCATION (figure 1).

Last month's article provided a brief outline of the development history of computers and their basic architecture. It was intended to give a general impression of what (micro-)processors are supposed to do in a (micro-)computing system.

The next step is to find out how they do it: in other words, to take a closer look at the general operating principles common to all microprocessors.

Figure 2 shows a representation of a location containing a byte. To be able to enter information ('data') into a memory, and to retrieve it from the memory, there must be some way of labelling the many different locations. For this purpose each location in the memory is given an ADDRESS, which is a binary word that defines the location. It is important to distinguish between the address of a location and the data which can be stored in that location. Both are binary words, but one (the address) is fixed and the other (the data) may change.

A memory may be visualised as a filing system, as shown in figure 3. Here, the locations are the drawers of the filing cabinet, into which data (files) may be placed, or from which data may be removed. The locations (drawers) are given addresses numbered 1 to 5, but of course the address of a drawer tells nothing about the data stored in that particular drawer, merely where the data may be found.

The number of locations that can be uniquely defined in a (micro-)computer memory is determined by the number of bits available for the addresses. In practice, address 0 is not normally associated with a location and so the number of locations in a memory is $2^n - 1$, where n is the number of bits in the address. With large capacity memories, notation of addresses in binary form becomes rather inconvenient. For example, where the address comprised 16 bits the number of locations would be 65535, a not too unwieldy number in decimal. However, in binary the address of the final location would be 1111111111111111. Since writing the addresses on paper in binary is unwieldy, and writing them in decimal and then converting them to binary for the computer is laborious, some compromise must be found: a system that is easy to write down and easy to convert. There are two commonly used methods of notation. The first of these is known as hexadecimal notation, in which the binary number is first split up into groups of four bits. Each of the groups of four bits is then replaced by a single symbol, there being sixteen symbols corresponding to the sixteen possible

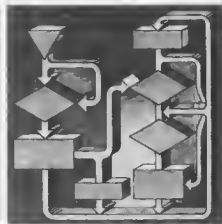

1



2



3



4

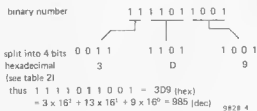

5

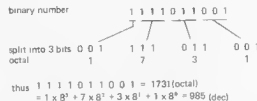

combinations of the four bits. The symbols used are digits 0 to 10 for 0000 to 1010 and letters A to F for 0111 to 1111. A 16-bit binary number can thus be represented by four hexadecimal symbols: 1110,0101,1111,0010. The hexadecimal code is convenient to write, and for example, would be E5F2. The hexadecimal code is convenient to write, and is simple to convert into either binary or decimal, as shown in the example of figure 4. Table 2 shows the derivation of hexadecimal notation.

The second notation system in common use is octal notation. In this case the binary number is split into groups of three bits, the possible combinations of which are represented by decimal numbers from 0 to 7. Again, this is easy to convert into either binary or decimal, as shown in figure 5. It is important, when working with these different number systems, not to confuse them with each other, as an example will show:

$372(\text{octal}) = 011,111,010 = 258(\text{decimal})$, whereas
 $372(\text{hexadecimal}) = 0011,0111,0010 = 985(\text{decimal})$.

A memory can be represented simply as a block with an address input and a data input (or 'port'), both with as many actual input lines as there are bits in an address and a data word respectively.

At this point it becomes necessary to distinguish between two main classes of memory, the Read Only Memory (ROM) and the Random Access Memory (RAM). The information contained in a ROM is fixed at the time of manufacture and cannot be altered. Information may thus only be READ out of a ROM, by applying the appropriate address to the address port, when the corresponding data will appear at the data port. ROMs are frequently used to store fixed programmes for dedicated applications of microprocessors.

Table 1.

7-BIT ASCII CHARACTER CODE

1000000	@	0110000	0
1000001	A	0110001	1
1000010	B	0110010	2
1000011	C	0110011	3
1000100	D	0110100	4
1000101	E	0110101	5
1000110	F	0110110	6
1000111	G	0110111	7
1001000	H	0111000	8
1001001	I	0111001	9
1001010	J	0111010	:
1001011	K	0111011	;
1001100	L	0111100	<
1001101	M	0111101	=
1001110	N	0111110	>
1001111	O	0111111	?
1010000	P		
1010001	Q	1100001	a
1010010	R	1100010	b
1010011	S	1100011	c
1010100	T	1100100	d
1010101	U	1100101	e
1010110	V	1100110	f
1010111	W	1100111	g
1011000	X	1101000	h
1011001	Y	1101001	i
1011010	Z	1101010	j
1011011	[1101011	k
1011100	\	1101100	l
1011101]	1101101	m
1011110	^	1101110	n
1011111	UNDERLINE	1101111	o
0100000	BLANK	1100000	p
0100001		1100001	q
0100010	"	1100010	r
0100011	#	1100011	s
0100100	\$	1100100	t
0100101	%	1100101	u
0100110	&	1100110	v
0100111	'	1100111	w
0101000	{	1110000	x
0101001	}	1110001	y
0101010	*	1110100	z
0101011	+		
0101100	COMMA		
0101101	DASH		
0101110	PERIOD		
0101111	/		

On the other hand, data may be WRITTEN into a RAM, as well as being read out, so a RAM is generally used for short-term data storage. In addition to address and data ports a RAM is equipped with a read/write enable line, the state of which determines whether application of an address causes data to appear at the output, or allows new data to be written into a particular location. A RAM may be equipped with separate data inputs and outputs, or the same port may serve for both data input and output.

ROMs

As stated above, the information stored in a ROM is fixed at the time of manufacture. However, a slightly different type of memory also exists: the Programmable Read Only Memory or PROM. PROMs are supplied with the

Figure 1. Symbolic representation of a memory cell and a location consisting of 8 memory cells.

Figure 2. An example of a byte (8-bit word) stored in a location.

Figure 3. A simple analogy of a memory is a filing system. The locations are drawers, the addresses the numbers of the drawers and the data the files stored in the drawers.

Figure 4. Example of converting a number from binary into hexadecimal and from hexadecimal into decimal.

Figure 5. Example of converting from binary to octal to decimal.

Table 1. Digits letters and symbols can be represented as binary numbers as this table of the well-known ASCII code shows.

Table 2. In the hexadecimal number system, 4-bit binary numbers can be represented by decimal digits supplemented by letters A to F.

Table 3. A comparison of decimal, binary, hexadecimal and octal numbers.

Table 2.

Decimal	Binary	Hexadecimal
0	$= 0 \times 2^3 + 0 \times 2^2 + 0 \times 2^1 + 0 \times 2^0 = 0000$	0
1	$= 0 \times 2^3 + 0 \times 2^2 + 0 \times 2^1 + 1 \times 2^0 = 0001$	1
2	$= 0 \times 2^3 + 0 \times 2^2 + 1 \times 2^1 + 0 \times 2^0 = 0010$	2
3	$= 0 \times 2^3 + 0 \times 2^2 + 1 \times 2^1 + 1 \times 2^0 = 0011$	3
4	$= 0 \times 2^3 + 1 \times 2^2 + 0 \times 2^1 + 0 \times 2^0 = 0100$	4
5	$= 0 \times 2^3 + 1 \times 2^2 + 0 \times 2^1 + 1 \times 2^0 = 0101$	5
6	$= 0 \times 2^3 + 1 \times 2^2 + 1 \times 2^1 + 0 \times 2^0 = 0110$	6
7	$= 0 \times 2^3 + 1 \times 2^2 + 1 \times 2^1 + 1 \times 2^0 = 0111$	7
8	$= 1 \times 2^3 + 0 \times 2^2 + 0 \times 2^1 + 0 \times 2^0 = 1000$	8
9	$= 1 \times 2^3 + 0 \times 2^2 + 0 \times 2^1 + 1 \times 2^0 = 1001$	9
10	$= 1 \times 2^3 + 0 \times 2^2 + 1 \times 2^1 + 0 \times 2^0 = 1010$	A
11	$= 1 \times 2^3 + 0 \times 2^2 + 1 \times 2^1 + 1 \times 2^0 = 1011$	B
12	$= 1 \times 2^3 + 1 \times 2^2 + 0 \times 2^1 + 0 \times 2^0 = 1100$	C
13	$= 1 \times 2^3 + 1 \times 2^2 + 0 \times 2^1 + 1 \times 2^0 = 1101$	D
14	$= 1 \times 2^3 + 1 \times 2^2 + 1 \times 2^1 + 0 \times 2^0 = 1110$	E
15	$= 1 \times 2^3 + 1 \times 2^2 + 1 \times 2^1 + 1 \times 2^0 = 1111$	F

Table 3.

Decimal	Binary	Hexadecimal	Octal
0	00000000	0	0
1	00000001	1	1
2	00000010	2	2
3	00000011	3	3
4	00000100	4	4
5	00000101	5	5
6	00000110	6	6
7	00000111	7	7
8	00001000	8	10
9	00001001	9	11
10	00001010	A	12
11	00001011	B	13
12	00001100	C	14
13	00001101	D	15
14	00001110	E	16
15	00001111	F	17
16	00010000	10	20
17	00010001	11	21
18	00010010	12	22
19	00010011	13	23
20	00010100	14	24
etc.	etc.	etc.	etc.

data in every memory cell set to either a 0 or 1, depending on the type of PROM. At a later date, any information specified by the customer can be written into the PROM using special programming equipment.

However, a PROM can only be programmed once, and if a programming mistake is made in so much as one bit, then the PROM is useless. Furthermore, if a programme modification becomes desirable the old PROM must be replaced.

This has proved a sufficient nuisance in practice to trigger the development of a third type of ROM: the REprogrammable Read Only Memory or REPROM. This can be used to store data permanently, like the PROM, but unlike the PROM the programming procedure is not irreversible. REPROM ICs are fitted with a special window over the chip, and the data can be erased

by exposing the chip to ultra-violet light. Any mistake in the programming procedure merely means that the data must all be erased and the programming started again.

A similar device to the REPROM is the Electrically Alterable Read Only Memory or EAROM. The principal difference is that programming and erasing is carried out using high voltages. REPROMs and EAROMs are often used to replace a ROM or PROM in development work, where a programme which will ultimately be fixed may be subject to alteration. Once the final programme has been determined then ROMs or PROMs will be used in the final product.

Despite the differences, ROMs, PROMs, REPROMs and EAROMs all have one thing in common: during normal use as part of a (micro-)computer system the information stored in these memories

cannot be changed. Data can only be read out, not written in.

RAMs

RAMs are used in applications where it is continually necessary to change the data in the memory, and they fall into two basic categories. Static RAMs use the inherent storage capability of bistable devices such as flip-flops. A static RAM will store information until the information is changed, or until the power is switched off. Dynamic RAMs store the data by charging capacitors, usually the gate capacitance of a MOSFET. Because of the tendency for this charge to leak away after a few milliseconds, dynamic RAMs must be continually REFRESHED to replenish the charge and avoid data being lost. In modern RAMs the refresh cycle is an automatic procedure that occurs every few milliseconds.

One disadvantage of both types of RAM is that the memory is volatile, that is to say that if power to the RAM is switched off then the data is lost. This makes RAMs unsuitable for very long-term storage of information. ROMs on the other hand will store information indefinitely, since the data is stored in the physical structure of the ROM, and is not dependent upon the state of an electrical circuit.

Memory word length

There are two methods of transferring and manipulating data, namely serial and parallel. Serial manipulation means that single bits are processed in sequence one after the other. In such a case the memory would have only one input line and the bits would be written in or read out one after the other. This would be rather time-consuming. Parallel processing means that the memory and other units in the computer have as many input/output lines as there are bits in a word, and all the bits are manipulated simultaneously. Only a single address is required to define the location of as many bits as there are input/output lines. Parallel processing obviously has advantages in terms of convenience and speed.

The size of a memory is usually defined in terms of the number of words it can store and the maximum permissible word length. For example, a memory might be specified as '1024 x 8 bit', meaning that it can store 1024 8-bit words.

Buses

A collection of lines over which information (for instance all 16 bits of a single address) can be transferred in parallel is known as a BUS.

In a computer system the memory must be capable of being accessed externally, through the input/output unit, or internally by the CPU. The memory, CPU and I/O unit must therefore all be connected to an address bus and a data bus (figure 7).

Since these 'buses' are basically nothing but multi-colored cables, the outputs of memory, CPU and I/O unit are all interconnected. For this reason conventional TTL- or MOS-technology cannot be used - the outputs would 'bite each other'. Instead, some system is required with three possible output conditions: 0, 1, or out-of-action.

These requirements are met by using TRI-STATE LOGIC, the principle of which is illustrated in figure 8. When the lower transistor is turned on (a), the output is pulled down to logic '0'. When the upper transistor is turned on (b), the output is pulled up to logic '1'. If neither transistor is turned on then the output is floating and presents a high impedance. When an output is not in use it is thus simply put into the high impedance state so that it will not load the output that is in use. Inputs, and the input sections of input/output ports,

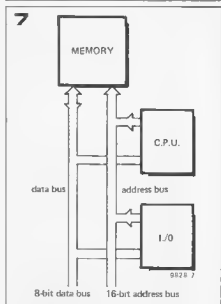
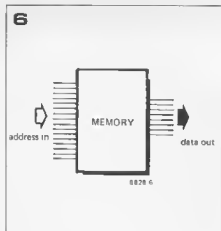

Figure 6. Representation of a memory as a block with a 16-bit address input and an 8-bit data port.

Figure 7. Communication within the microprocessor is carried out over buses for data and addresses.

Figure 8. A tri-state logic output can function as a normal logic output, or can be put into a high impedance state to isolate it from the bus.

Figure 8. The control bus co-ordinates the connection of the various units to the address and data buses.

Figure 10. Block diagram of a simple CPU.

can be permanently connected to the bus, since they have a high impedance and do not load the bus significantly.

There is obviously a necessity for some control system to put the various ports of the system into the correct state for any particular transfer of data. This control is effected by a third bus, known as the 'control bus' (figure 9).

The CPU

Having discussed memories, and the methods by which data can be transferred around the microcomputer system, the function of the Central Processing Unit (CPU) may be investigated. As mentioned earlier, a microprocessor (also called Microprocessing Unit or MPU) is really a small CPU.

The CPU is the 'brain' of the microcomputer system, and in a few words the function of the CPU is to control the operation of the other units in the microcomputer and to process data in accordance with the programme in order to produce useful results.

The question of what constitutes a programme then immediately arises. In a nutshell, a programme is simply a logical sequence of INSTRUCTIONS that has been put into memory by the programmer to tell the CPU what operations are to be performed on the data. Just what these instructions can depend on the INSTRUCTION SET of a particular MPU chip, but some typical instructions will be discussed later.

Figure 10 shows a typical internal block diagram of a simple CPU. The functions of the various blocks are as follows:

Address Register (AR). This is a temporary store for addresses whose output is the address bus.

Programme Counter (PC). This counter simply counts the steps of the programme. Its output can be fed, via the address register, onto the address bus to access the memory for the retrieval of programme instructions.

Data Register (DR). Data retrieved from the memory is temporarily stored here.

Instruction Decoder (ID). Takes programme instructions which have been retrieved from memory and decodes them for the control unit.

Control Unit (CU). This is basically a system of counters and logic gates which is driven by the clock generator. Its outputs control the other units within the microprocessor and ensure that operations are carried out in the correct order.

Accumulator (ACC). This is a register in which data can be temporarily stored.

Arithmetic Logic Unit (ALU). This is the heart of the CPU, and carries out all the manipulations of and operations on the data.

In order to understand the operation of the CPU, a simple programme can be considered. Suppose two numbers x and y are to be added and the result z is to be stored in the memory. The addresses of the locations in which x , y and z are

stored will be called A, B and C respectively.

It may seem rather disappointing, but a microprocessor is a very stupid device. Even for a simple addition like this it requires a detailed series of step-by-step instructions. In this case, the first steps are to retrieve the first number, x, from the memory and transfer it to the CPU. This procedure requires two programme steps. LOAD A. These instructions are also stored in the memory, for example in addresses 0001 and 0002 (hexadecimal) respectively, as shown in figure 11.

The sequence of events is initiated by setting the programme counter to the first address: 0001. This number will be stored in the address register and used to access the memory. The data stored in location 0001 will consist of the instruction LOAD, which will be read out onto the data bus and thence into the data register and instruction decoder. The instruction is decoded and the control unit prepares the CPU to carry out the instruction.

The CPU now needs to know the location of the number which is to be loaded, so the programme counter is incremented to 0002, which now appears at the output of the address register to address the memory. In location 0002 the second programme step was stored: address A, which in this example is 0011. This address is retrieved from the memory along the data bus, and is loaded into the address register instead of the programme counter output. The data (x) in location A is

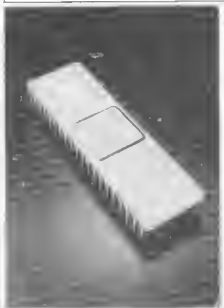
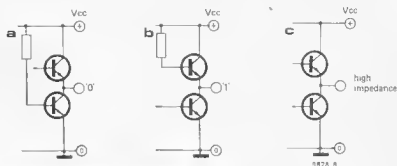
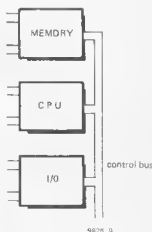
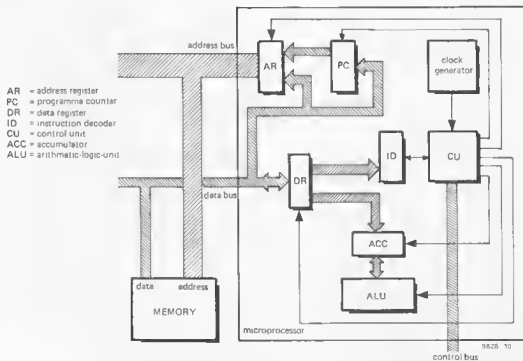
8**9****10**

now retrieved from the memory and loaded into the accumulator.

This completes the 'loading' of 'x', and the next steps in this programme are to 'add' 'y'. Since the CPU hasn't been told to stop, the programme counter will again be incremented and its output (0003) is stored in the address register.

The data stored in location 0003 is the next instruction, which, since x and y are to be added, is the instruction ADD. The CPU now needs to know the location of the number that is to be added to the contents of the accumulator, so the programme counter is again incremented and the data stored in location 0004 is retrieved. Since the CPU is looking for an address, it assumes (correctly) that this data (0017) can be used to address the memory and retrieve the number y. Since the previous instruction was ADD (not LOAD), the arithmetic logic unit will ensure that this number is added to the original contents (x) of the accumulator. The final operation is to store the result (z) of the addition in location C. The programme counter is incremented to 0005, this number is used to address the memory, and the next instruction is retrieved. STORE.

The programme counter is then incremented to 0006, and the address C (000E) is retrieved from the memory. This is fed into the address register, and z is written into that location.

It would seem that this completes the programme, but one thing still remains to be done: inform the microprocessor that this is indeed the case. The programme counter is again incremented, to 0007, and this location contains the final instruction: STOP. The instruction decoder passes this message on to the control unit, and the control unit stops the programme counter. It is apparent that each operation in the programme requires two steps. First, an instruction is retrieved from the memory and secondly the data is retrieved from the memory and the operation is performed upon it. These two steps are called the FETCH and EXECUTE cycles.

The ALU

It was stated earlier that the Arithmetic Logic Unit is the heart of the CPU. It is this unit that carries out all the manipulative logic and arithmetic operations on the data.

A typical ALU would be capable of carrying out the following functions:

- 1) Binary addition (ADD).
- 2) Boolean Logic operations (AND, OR, EXOR).
- 3) Complementing/inversion (including NOT functions).
- 4) The capability to shift data one place or more to the left or right (a shift register).

The data to be manipulated will have been entered into the accumulator, and from there it is transferred to a Buffer Register in the ALU.

An ALU intended to handle 8-bit data



Figure 11. Showing how the programme to add x to y and store the result is held in the memory, together with the numbers x, y and the result z.

Figure 12. Block diagram of the functions contained in the ALU block of figure 10.

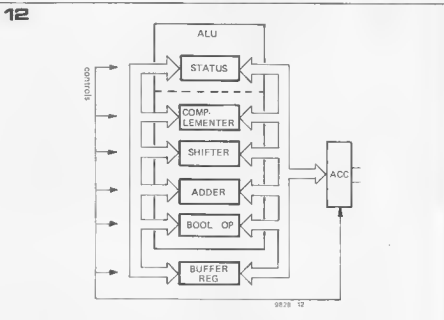

words must therefore contain the following logic functions: an 8-bit register; an 8-bit binary adder; 8 AND-OR- and EXOR gates, the Boolean Operations section; 8 inverters and an 8-bit shift register (figure 12). In practice not all these logic functions may be present as such. For example, AND functions and EXOR functions may be performed by OR-gates supplemented by a number of inverters. These functions will form part of the instruction set of the MPU.

Another important component of the ALU is the STATUS REGISTER, which consists basically of a number of flip-flops capable of storing certain information known as FLAGS.

For example, the manipulation of data in the accumulator might produce a negative result, in which case this information would be stored in a flip-flop as a flag bit known as SIGN STATUS. The result of a manipulation might be zero, in which case a ZERO

STATUS flag would be stored.

On the other hand, the result of a data manipulation might be a word longer than 8-bits, in which case OVERFLOW STATUS would be indicated.

Still other flags are possible, which vary depending on the type of MPU chip used. However, further discussion of instruction sets and flags is pointless without reference to a particular type of microprocessor system. The only real way to learn about microprocessors is by 'hands-on' experience of programming an actual system.

For this reason the discussion of microprocessors in Elektor will be continued along more practical lines using a tutorial system based on the National Semiconductor SC/MP.

Literature:

'From the computer to the micro-processor', Hervé Tireford, Motorola.
'An introduction to microcomputers (volume 1)', Adam Osborne, Sybex.

up-to-date electronics for lab and leisure

ELEKTOR 30

exclusive offer from elektor available only to our readers



Last year we published 3 'special issues', with circuit designs for cars, Television games and Domestic Circuits, but this year we are making an exclusive offer commencing with this issue. Offer available only to our readers

PLUS
a bonus for subscribers.

If you don't subscribe to Elektor already now is the time so you can take full advantage of our exclusive offer PLUS bonus.

There are only 2 issues left for 1977, November and December. You can subscribe for these 2 issues now for Only 45 p each (P & P extra).

Send in your order now using the coupon overleaf, no stamp needed and no need to pay with your order, we will send you an invoice. Don't leave it too late as we expect to sell out very quickly.

plus

FREE SAMPLE ISSUE

Total subscription price only £ 1.05
(incl. P & P) for Nov. & Dec. issues

Please show this copy of Elektor to your friends and colleagues and tell them they can send for a free sample issue, no stamp needed, just fill in the coupon overleaf and tick the appropriate box.

Elektor binders, back issues and printed circuit boards are all available direct from us. A list of available back issues and prices of these and the Elektor Binder are detailed overleaf. For printed circuit boards please refer to the EPS list in the front of every issue.

