

up-to-date electronics for lab and leisure

ELEKTOR 26

June 1977 45P / USA \$ 1.50

loudspeaker crossover filters • levitator • precision timebase

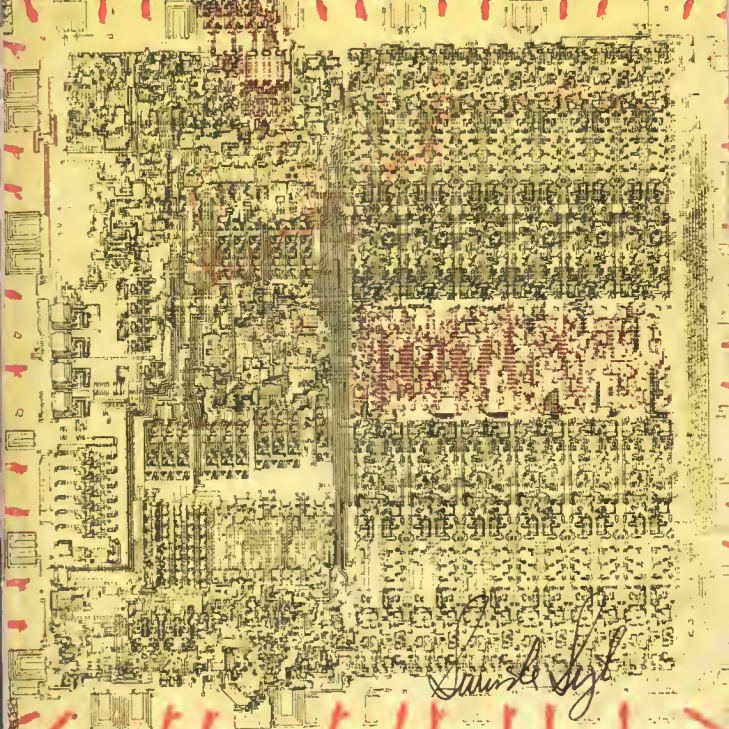

ELEKTOR

Editor : W. van der Horst
 Deputy editor : P. Holmes
 Technical editors : J. Barendrecht
 G.H.K. Dam
 E. Krömpelsauer
 G.H. Nachbar
 Fr. Scheel
 K.S.M. Walraven
 Art editor : C. Sinke
 Subscriptions : Mrs. A. van Meyel

U.K. editorial offices, administration and advertising:
 B. Stour Street, Canterbury CT1 2XZ, Kent, U.K.
 Tel.: Canterbury (0227)-54430. Telex: 965504.

Bank: 1. Midland Bank Ltd., Canterbury, A/C no. 11014587,
 Sorting code 40-16-11, Giro no. 3154254.
 2. U.S.A. and Canada: c/o World Way Postal Center
 P.D. Box B0689, Los Angeles, Cal. 90080,
 A/C no. 12350 04207.

Assistant Manager and Advertising : R.G. Knapp
 Editorial : T. Emmens

Elektor is published monthly on the third Friday of each month.

1. U.K. and all countries except the U.S.A. and Canada:

Cover price £ 0.45.

Number 27/28 (July/August), is a double issue, 'Summer Circuits', price £ 0.90.

Single copies (incl. back issues) are available by post from our Canterbury office, at £ 0.60 (surface mail) or £ 0.95 (air mail). Subscriptions for 1977, January to December incl., £ 6.25 (surface mail) or £ 11.— (air mail).

Subscriptions from July/August to December 1977 £3.05 (surface mail).

2. For the U.S.A. and Canada.

Cover price \$ 1.50.

Number 27/28 (July/August), is a double issue, 'Summer Circuits', price \$ 3.—.

Single copies (incl. back issues) \$ 1.50 (surface mail) or \$ 2.25 (air mail).

Subscriptions for 1977, January to December incl., \$ 18.— (surface mail) or \$ 27.— (air mail).

Subscriptions from July/August to December 1977, \$9.00 (surface mail). All prices include post & packing.

Change of address. Please allow at least six weeks for change of address. Include your old address, enclosing, if possible, an address label from a recent issue.

Letters should be addressed to the department concerned:

TO = Technical Queries; ADV = Advertisements; SUBS = Subscriptions, ADM = Administration; EDV = Editorial articles submitted for publication etc.; EPS = Elektor printed circuit board service. For technical queries, please enclose a stamped, addressed envelope.

The circuits published are for domestic use only. The submission of designs or articles to Elektor implies permission to the publishers to alter and translate the text and design, and to use the contents in other Elektor publications and activities. The publishers cannot guarantee to return any material submitted to them. All drawing, photographs, printed circuit boards and articles published in Elektor are copyright and may not be reproduced or imitated in whole or part without prior written permission of the publishers.

Patent protection may exist in respect of circuits, devices, components etc. described in this magazine.

The publishers do not accept responsibility for failing to identify such patent or other protection.

National advertising rates for the English edition of Elektor and/or international advertising rates for advertising at the same time in the English, Dutch and German issues are available on request.

Distribution: Spotlight Magazine Distributors Ltd,
 Spotlight House 1, Bentwell Road, Holloway, London N7 7AX.

Copyright © 1977 Elektor publishers Ltd — Canterbury.

Printed in the Netherlands.

DECODE

What is a TUN?
 What is 10 n?
 What is the EPS service?
 What is the TQ service?
 What is a missing link?

Semiconductor types

Very often, a large number of equivalent semiconductors exist with different type numbers. For this reason, 'abbreviated' type numbers are used in Elektor wherever possible:

- '741' stand for μ A741, LM741, MC641, MIC741, RM741, SN72741, etc.
- 'TUN' or 'TUN' (Transistor, Universal, PNP or NPN respectively) stand for any low frequency silicon transistor that meets the following specifications:

VCE0, max	20V
IC, max	100 mA
If, min	100
Ptot, max	100 mW
fT, min	100 MHz

Some 'TUN's are: BC107, BC108 and BC109 families; 2N3856A, 2N3859, 2N3860, 2N3904, 2N3947, 2N4124. Some 'TUN's are: BC177 and BC178 families; BC179 family with the possible exception of BC150 and BC179; 2N2412, 2N3251, 2N3906, 2N4126, 2N4291.

a 'DUS' or 'DUG' (Diode Universal, Silicon or Germanium respectively) stands for any diode that meets the following specifications:

	DUS	DUG
VR, max	25V	20V
If, max	100mA	35mA
IR, max	1 μ A	100 μ A
Ptot, max	250mW	250mW
CD, max	50pF	10pF

Some 'DUS's are: BA127, BA217 BA218, BA221, BA222, BA317, BA318, BA319, BA413, BA461, 1N914, 1N4148.

Some 'DUG's are: OA85, OA91, OA95, AA116.

a 'BC107B', 'BC237B', 'BC547B' all refer to the same 'family' of almost identical better-quality silicon transistors. In general, any other member of the same family can be used instead.

BC107 (-8, -9) families:
 BC107 (-8, -9), BC147 (-8, -9),
 BC207 (-8, -9), BC237 (-8, -9),
 BC317 (-8, -9), BC347 (-8, -9),
 BC547 (-8, -9), BC171 (-2, -3),
 BC182 (-3, -4), BC382 (-3, -4),
 BC437 (-8, -9), BC414

BC177 (-8, -9) families:
 BC177 (-8, -9), BC157 (-8, -9),
 BC204 (-5, -6), BC307 (-8, -9),
 BC320 (-1, -2), BC350 (-1, -2),
 BC557 (-8, -9), BC251 (-2, -3),
 BC212 (-3, -4), BC512 (-3, -4),
 BC261 (-2, -3), BC416.

Resistor and capacitor values
 When giving component values, decimal points and large numbers of zeros are avoided wherever

possible. The decimal point is usually replaced by one of the following abbreviations:

p (pico-) = 10^{-12}

n (nano-) = 10^{-9}

μ (micro-) = 10^{-6}

m (milli-) = 10^{-3}

k (kilo-) = 10^3

M (mega-) = 10^6

G (giga-) = 10^9

A few examples:

Resistance value 2k7: 2700 Ω .

Resistance value 470: 470 Ω .

Capacitance value 4p7: 4.7 pF, or

0.000 000 000 004 7 F ...

Capacitance value 10n: this is the

international way of writing

10,000 pF or .01 μ F, since 1 n is

10^{-9} farads or 1000 pF.

Resistors are $\frac{1}{2}$ Watt 5% carbon

types, unless otherwise specified.

The DC working voltage of

capacitors (rather than electro-

lytics) is normally assumed to be

at least 100 V. As a rule of thumb,

a safe value is usually approxi-

mately twice the DC supply

voltage.

Test voltages

The DC test voltages shown are

measured with a 20 k Ω /V instru-

ment, unless otherwise specified.

U, not V

The international letter symbol

'U' for voltage is often used

instead of the ambiguous 'V'.

'V' is normally reserved for 'Volts'.

For instance: $U_B = 10$ V,

not $V_B = 10$ V.

Mains voltages

No mains (power line) voltages

are listed in Elektor circuits. It is

assumed that our readers know

what voltage is standard in their

part of the world!

Readers in countries that use

60 Hz should note that Elektor

circuits are designed for 50 Hz

operation. This will not normally

be a problem; however, in cases

where the mains frequency is used

for synchronisation some modifi-

cation may be required.

Technical services to readers

EPS service. Many Elektor

articles include a lay-out for a

printed circuit board. Some — but

not all — of these boards are avail-

able ready-stamped and drilled.

The 'EPS print service list' in the

current issue always gives a com-

plete list of available boards.

Technical queries. Members of

the technical staff are available to

answer technical queries (relating

to articles published in Elektor)

by telephone on Mondays from

14.00 to 16.30. Letters with

technical queries should be

addressed to: Dept. TO. Please

enclose a stamped, self addressed

envelope; readers outside U.K.

please enclose an IRC instead of

stamps.

Missing link. Any important

modifications to, additions to,

improvements on or corrections

in Elektor circuits are generally

listed under the heading 'Missing

Link' at the earliest opportunity.

CONTENTS

26

Volume 3
Number 6



The precision timebase for frequency counters consists of a PLL 200kHz receiver and a TTL divider stage. Both parts are clearly visible on the photo.



Lovers of acronyms (specifically the inventors of new technologies and semiconductor devices) may refer to the operating principle of the levitator as MASFOCMA — for Mid-Air Suspension of Ferrous Objects by Controlled Magnetic Attraction.

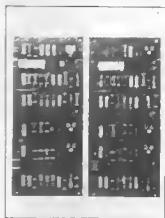

The printed circuit board for the active loudspeaker crossover filters will accommodate either a two-way or three-way filter, with slopes of 18-, 12- or 6 dB/oct. Individual preset gain controls are available for all outputs.



This month's cover gives an impression of what the words 'Large Scale Integration' stand for. The actual size of this particular chip is approximately the same as the '0' in Elektor on the 'Small Scale Reproduction' of the cover reproduced here.

missing link	6-07
Phasing and vibrato, LINK 76	
selektor	6-11
formant — the elektor music synthesiser (2)	6-14
C. Chapman	
Having discussed the basics of a synthesiser in last month's introductory article, the second part of this series gets down to some of the practical aspects, namely the keyboard and keyboard electronics	
digibell envelope shaper	6-21
precision timebase for frequency counter	6-22
The accuracy of a frequency counter is determined exclusively by the accuracy of the timebase being used. Thus if extremely precise measurement of frequencies is required, as is the case for example when calibrating crystal oscillators, then a precision timebase is necessary. This can be achieved in a relatively simple manner, using the carrier wave signal of the 200 kHz broadcast transmitter at Droitwich.	
slotless model car track (3)	6-26
Having described the multiplex encoder, infra-red transmitter and receiver in the previous two articles, the next important component in the control chain is the servo amplifier, which converts the variable width control pulses into a corresponding position of the steering servo.	
levitator	6-30
In view of the current interest in magnetic levitation for applications such as hovertrains (see Elektor 22 p. 2-08) it was felt that a magnetic levitator would make an interesting laboratory demonstration for students	
The practical difficulties of cryogenic engineering and the fate of the brass monkey led to the abandonment of the superconducting approach at an early stage of development, and the system finally decided upon was controlled ferromagnetic attraction. The system provides an amusing demonstration and an interesting Introduction to feedback control systems.	
ejektor	6-35
active filters for the 'filler driver' principle	
active loudspeaker-crossover filters (2)	6-37
The first part of this article dealt with the design considerations concerning loudspeaker crossover filters in general, and active crossover filters in particular. This month a practical circuit is given, with details on how to modify it according to personal taste	
market	6-46
advertiser's index	6-56

formant = the elektor music synthesiser

(C. Chapman)

Part 2

Having discussed the basics of a synthesiser in last month's introductory article, the second part of this series gets down to some of the practical aspects, namely the keyboard and keyboard electronics.

Before beginning the discussion, it must be stressed that 'Formant' is not a suitable project for the beginner. The complexity of the synthesiser demands a high degree of competence in soldering p.c. boards and interwiring if an unacceptably large number of faults are not to arise. Some knowledge of operational amplifier basics is also almost essential. Nor should the project be undertaken by anyone who does not have access to an oscilloscope, a good multimeter, and preferably a digital voltmeter.

Top grade components are also a must. Where specified 1% metal film or metal oxide resistors must be used. All other resistors should be good quality 5% car-

bon film types, while capacitors (except where the capacitance demands an electrolytic) should be low loss, low leakage types such as polycarbonate, polyester or polystyrene. Ceramic capacitors should not be used. Semicconductors too should be first-grade devices from a reputable source, not 'unmarked, untested' manufacturer's rejects. The temptation to save money by buying dubious components should be avoided, as unsatisfactory performance will almost certainly be the result.

The synthesiser comprises two separate units, the module unit containing VCO's, filters, power supplies etc, and the manual unit containing the key-

board. These two units are interconnected by cables with plug and socket terminations and can be separated for transportation or storage.

The keyboard is a 37-note C to C keyboard fitted with Kimber-Allen two-pole normally open contact blocks. The keyboard used in the prototype was an SKA type. This keyboard is recommended for the project and the descriptions given will relate to it, though other types may also be suitable. The keyboard consists of an aluminium chassis with dimensions similar to those given in figure 1, to which the keys and return springs are assembled. The key contacts are depressed by a plastic actuator on the underside of each key, which protrudes through a hole in the chassis (see figure 1c). Contact blocks are supplied separate from the keyboard, and the first task is to assemble the contacts to the underside of the chassis as shown in figures 2a and 2b. The contact blocks must be spaced away from the chassis so that the actuator (A) just touches the movable contact with the key in the rest position. A strip of 3 mm thick perspex or other plastic makes a suitable spacer (F). The simplest method of fixing the contact blocks in position is to glue them to the plastic spacer using quick setting epoxy adhesive, taking care not to get any adhesive into the 'works' of the contact block. For those preferring a more easily separable assembly the slot in the underside of the contact will accept a rectangular section metal strip which will clamp the contacts to the chassis using nuts and bolts.

Keyboard interface

The principle of the synthesiser keyboard, which was briefly explained in part 1, is shown again in figure 3. The function of one contact-set on the keyboard is to provide a control voltage to the voltage-controlled modules of the

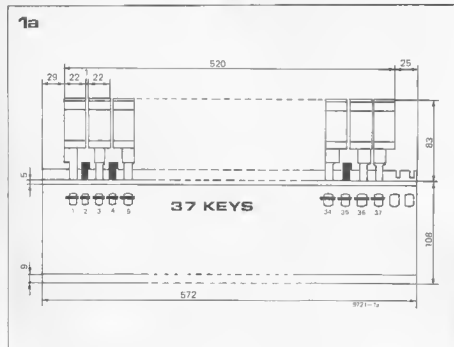

Figures 1a, 1b and 1c. Mechanical details of the SKA keyboard. (A) Keys. (B) Contact actuator. (C) Chassis.

Figures 2a and 2b. Showing the mounting of the key contact blocks. (A) Key. (B) Actuator. (C) Chassis. (D) Contact block. (E) Divider board. (F) Spacer.

1b



1c

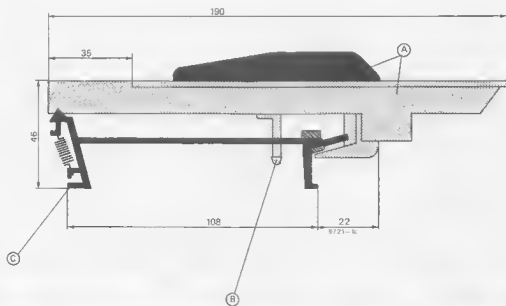

2a

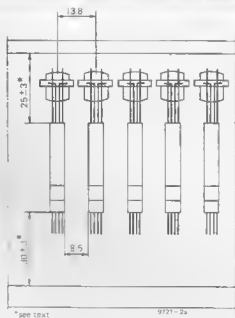

2b

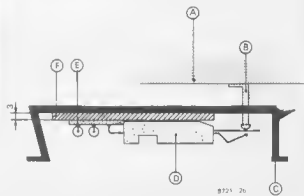

3

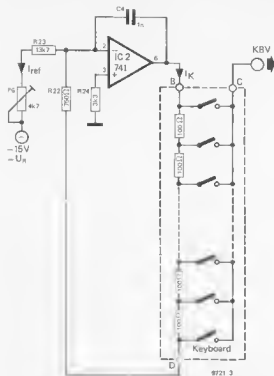

synthesiser. Each key can be used to switch a voltage from a particular point in a potential divider comprising equal value close tolerance resistors fed from a constant current source. The control characteristic of the Formant is 1 octave/volt so each resistor in the chain must drop $1/12$ V giving a step of $1/12$ V per semitone.

In figure 3 the constant current source is built around IC2, a 741 op amp. From the -15 V stabilised supply a constant current flows through P6 and R23. Since only a negligible bias current can flow into the inverting input of the 741 this same current must also flow out of the op amp output and through the potential divider chain back to the inverting input. Since R24 holds the non-inverting input at ground potential the voltage at the junction of R22 and R23 is also zero — a 'virtual earth' point. P6 can be adjusted to give a current of $833 \mu\text{A}$ or a voltage drop of $1/12$ V across each 100Ω resistor, i.e. 83.3 mV. In practice the voltage will not be exactly 83.3 mV but will be somewhat higher to compensate for voltage losses in other parts of the circuit.

It may seem rather strange to use a stabilised reference voltage to produce a constant current which in turn is used to produce a constant voltage. Why not simply feed the potential divider from a constant voltage in the first place? The answer is quite simple. Since the synthesiser is a monophonic instrument only one note can be played at once. If the divider chain were fed from a voltage source and several keys were depressed simultaneously, either by accident or intentionally, then part of the divider chain would be shorted out, increasing the voltage drops across the remaining (unshorted) resistors and giving a discordant note. Feeding from a

constant current source means that, even if part of the chain is shorted out the voltage drops across the remaining resistors will stay correct and the note sounded will actually be the lowest note of those played.

Sample and hold circuit

It is not possible directly to use the output voltage of the keyboard to control the synthesiser, since immediately a key is released that voltage disappears abruptly, and so would any tone that was controlled by it, making effects such as sustain impossible. For this

Figure 3. Circuit of the keyboard divider chain and current source.

Figure 4. Showing the principles of a sample-and-hold circuit.

Figure 5. The dual sample-and-hold circuit used in the Formant.

Figure 6. Showing the output waveforms of the keyboard interface when playing a scale (a) normally and (b) portamento.

Figure 7. Circuit of the portamento stage. P1 controls the 'smoothness' of the portamento.

Figure 8. Circuit of the offset compensation, octave tuning and frequency modulation stage.

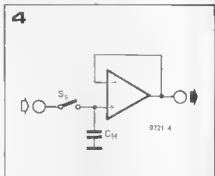

reason the output voltage of the keyboard is stored in a sample and hold circuit. This consists basically of a switch and a capacitor connected to the input of an op amp in voltage follower configuration. When the switch is closed the capacitor charges rapidly to the same level as the input voltage. The op amp output also assumes this level. If the switch is now opened then, assuming the op amp has a high input resistance, the capacitor can discharge only extremely slowly, so the op amp maintains its output voltage for a long time. There are a number of difficulties

5

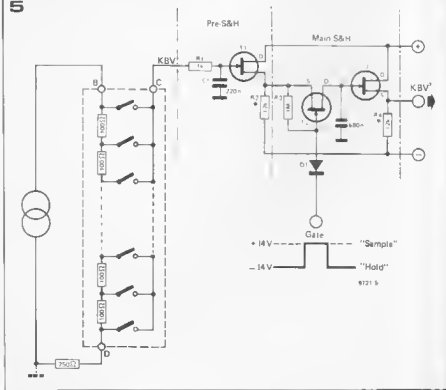

6a

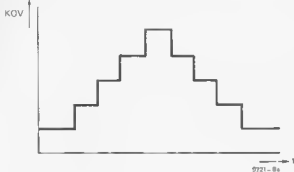

6b



7

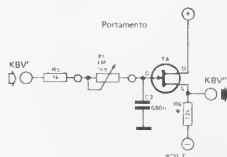

8

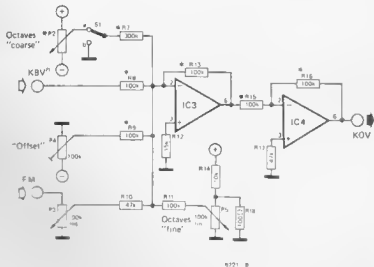

inherent in this simple approach. Firstly, since the switch in figure 4 corresponds to a key contact of the keyboard, the leakage resistance of the switch when open is the leakage resistance of 37 key contacts connected in parallel, which can be quite low, especially in a humid environment. This could be overcome by increasing the value of the capacitor so that it discharges more slowly, but it would then take much longer to charge from the keyboard divider chain, which would result in unwanted 'glissando' effects.

The solution is to use a double sample-and-hold circuit, as shown in figure 5. The pre S and H circuit stores the output of the keyboard on a small capacitor C1, the output being buffered by a source follower FET T1. Before the voltage on C1 can decay due to the key contact leakage the voltage at the source of T1 is transferred to a larger capacitor C2 by an electronic switch T2. The 'off' resistance of this switch is much higher than that of the keyboard, and T3 has a high input resistance, so C2 can hold its charge for quite a long time. T2 is switched by a gating pulse controlled by the second contact set of the keyboard. The cathode of D1 is normally at -14 V and T2 is thus cut off. When a key is depressed the gate pulse takes the cathode of D1 up to +14 V and T2 turns on.

Portamento control

When playing up and down a scale the control voltage from the source of T3 would normally consist of a series of discrete steps, as shown in figure 6a. This would give rise to equally discrete changes of pitch, the minimum change in pitch being one semitone interval of the tempered scale, as with any other keyboard instrument. However, many instruments are characterised by the ability to make continuous (smooth) changes of pitch, one example being the trombone with its slide. This style of playing is known as 'portamento'.

The circuit of a portamento stage is given in figure 7. It consists simply of a source follower FET, preceded by an RC network that integrates the stepwise output of T3 to give a much smoother change as shown in figure 6b. P1 controls the 'smoothness' of the change. Note that, due to the FET tolerances, the source resistors R2, R4 and R6 must be selected on test, and this will be described in part 3.

Overall tuning, frequency modulation and offset balance

FETs connected as source followers differ in two essential respects from ideal voltage followers. Firstly, between gate and source there is always the gate-source voltage of the FET, which means that the source is always at a higher voltage than the gate. This appears as an undesirable positive offset voltage at the source of the FET, and since, in this circuit, three FETs are connected in cas-

9

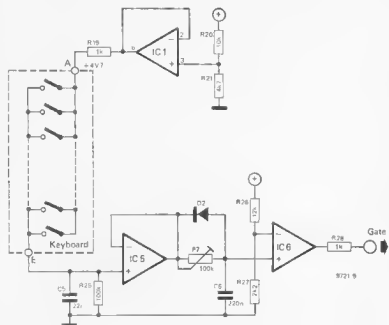

cade these offset voltages are additive. Secondly, the gain of a source follower is slightly less than unity, which means that a 1 V change on the gate does not produce a 1 V change at the source.

The offset voltage is compensated for in the circuit of figure 8. This comprises two IC op amps. IC3 is connected as an inverting summing amplifier, while IC4 is connected as a unity gain inverter to restore the correct sense of the control voltage. A negative voltage controlled by P4 may be summed with the control voltage input (KBV) to cancel out the positive offset voltage.

The gain losses in the sample and hold and portamento stages are compensated by increasing the current through the keyboard divider chain by means of P6 in figure 3 until a control characteristic of 1 octave/volt is obtained at the output of IC4.

The circuit of figure 8 performs two additional functions. By adding a variable DC voltage to the control voltage the entire tuning range of the synthesiser may be shifted. P2 provides an adjustment of about 5 octaves, while P5 provides a fine adjustment of about \pm one semitone, so that the synthesiser can easily be tuned to match other instruments.

A further input is provided for frequency modulation, for example to

10

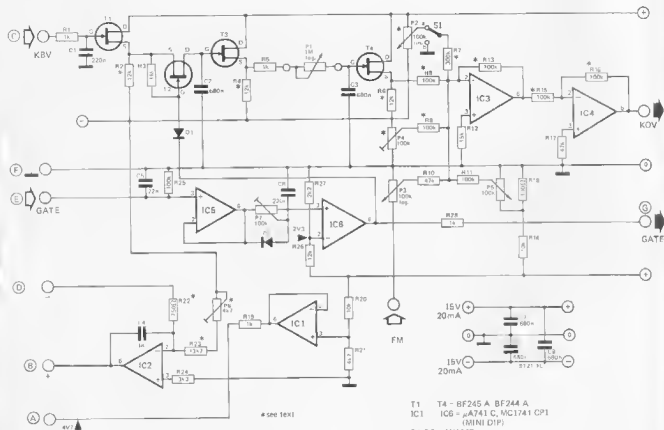

T1 T4 - BF245 A BF244 A
IC1 IC6 - μ A741 C, MC1741 CP1
(MINI DIP)
D1 D2 = 1N4148

11

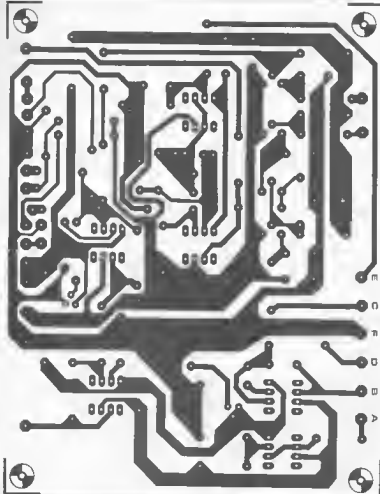

Parts list to figure 11.

Resistors:

- R1, R5, R19, R28 = 1 k
- R2, R4, R6 = 12 k (nominal value, see part 3)
- R3 = 1 M
- R7 = 300 k (1% metal oxide)
- R8, R9, R13, R15, R16 = 100 k (1% metal oxide)
- R10, R17 = 47 k
- R11, R25 = 100 k
- R12 = 15 k
- R14, R20 = 10 k
- R18 = 100 Ω
- R21 = 4k7
- R22 = 750 Ω (1% metal oxide)
- R23 = 13k7 (1% metal oxide)
- R24 = 3k3
- R26 = 12 k
- R27 = 2k2

Presets:

- P4 = 100 k (Cermet)
- P6 = 4k7 (5 k, Cermet)
- P7 = 100 k

Potentiometers:

- P1 = 1 M log.
- P2 = 100 k lin. (Cermet)
- P3 = 100 k log.
- P5 = 100 k lin.

Capacitors:

- C1, C6 = 220 n
- C2, C3, C7, C8, C9 = 680 n Low leakage, low loss e.g.
- C4 = 1 n Siemens MKM,
- C5 = 22 n Wima FKS.

Semiconductors*

- T1... T4 = BF245A, BF244A (selected, see part 3)
- IC1... IC6 = μ A 741 C, MC 1741CP1 (Mn⁺-DIP)
- D1, D2 = 1N4148

Notes: Except where otherwise specified resistors should be 5% carbon film. Metal oxide types should be 1% or better with temperature coefficient 100 ppm/ $^{\circ}$ C max. Presets and pots, where specified, should be single turn cermet types. In some cases (e.g. for R23) 1% resistors are specified for their long term and temperature stability, not for the exact value. If this value is difficult to obtain, a close approximation may be chosen, provided a 1% metal oxide resistor is used.

Figure 9. Circuit of the gate pulse generator, which is activated by the second contact set of the keyboard.

Figure 10. Complete circuit of the keyboard interface circuit.

Figure 11. Printed circuit board end component layout for the keyboard interface circuit. (EPS 9721-1)

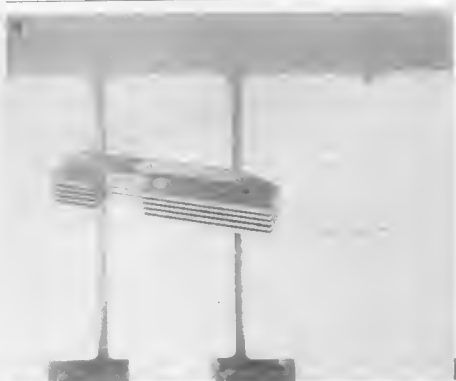

provide vibrato. The modulation level can be adjusted by means of P3, and with P3 fully clockwise the 'sensitivity' of this input is about 1 octave per 500 mV.

Gate circuit

Because of the action of the sample and hold circuit, once a key has been depressed the control voltage remains at the KOV output until another key is depressed. This would cause a note, once pressed, to sound indefinitely were it not for the envelope circuits that control the attack, sustain and decay of the notes.

Gate pulses to control the sample-and-hold circuit and to control the envelope shapers are derived from the second set of keyboard contacts. As shown in figure 9, these are all connected in parallel and fed with 4.7 V DC from IC1. When a key contact closes the output of IC5 immediately goes to +4.7 V. C6 charges via P7 until its voltage exceeds the voltage on the inverting input of IC6 (IC6 functions as a comparator) when the output of IC6 will swing positive. When the key is released the output of IC5 will become zero and C6 will discharge rapidly through D2 so that the output of IC6 will swing negative.

The RC network P7/C6 provides an adjustable delay that compensates for a difference in closing time between the two sets of contacts. For example, should the gating contact close before the control voltage contact then the synthesiser would first sound a note determined by the residual voltage on C1 in figure 5. Then when the control voltage contact closed the correct note would sound. The delay network ensures that the gate pulse is delayed until after the new control voltage has been applied to C1. However, since C6 discharges rapidly through D2 the gate pulse ends immediately the key is released. C5 and R25 at the input to IC5 help to suppress noise due to contact bounce.

Construction

Figure 10 shows the complete circuit of the keyboard interface, while the printed circuit board and component layout are given in figure 11. The p.c. board for the divider chain will be given next month. In the third part of the article the description of the module unit will also begin, together with wiring details for the keyboard interface.

Photo 1. A Kimber-Allen contact block as used in the synthesiser.

Photo 2. Close-up of the contact blocks mounted on the underside of the keyboard.

Photo 3. View of the completed keyboard with the divider chain p.c. board in position.

digibell envelope shaper

(W. Kunz)

This circuit is intended to improve the sound of the 'Digibell', which was published in Elektor No 14 (June 1976). The tones produced by the original Digibell circuit, which is reproduced in figure 1, terminate abruptly at the end of each note in the sequence. The simple envelope shaper described here causes the notes to die away exponentially, which is much more natural and acceptable to the ear.

The circuit, which is given in figure 2, functions as follows: in the interval between notes T1 is turned off so the base of T2 is biased to about 1.5 V by R1, D1, R2 and R3. Immediately a note appears at pin 12 of IC7 it will be amplified by T2. However, pin 11 of IC4 will go high for the duration of the note, turning on T1 which shorts R1 to

ground. C1 will now begin to charge through R2 and R3, so the base voltage of T2 will fall and the note will gradually decay as T2 slowly turns off. D1 is reverse biased during this time and prevents T1 from influencing this part of the circuit.

It may be necessary to experiment with the value of C1 to ensure that the note has decayed completely before it is abruptly cut off by the sequencing of the Digibell circuit.

1

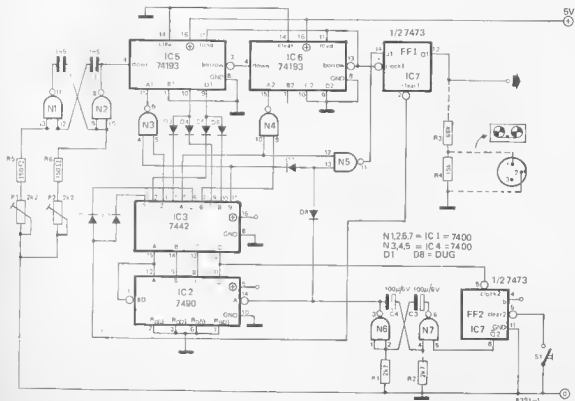

2

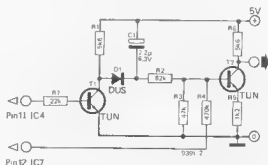

precision timebase for frequency counter

The accuracy of a frequency counter is determined exclusively by the accuracy of the timebase being used. Thus if extremely precise measurement of frequencies is required, as is the case for example when calibrating crystal oscillators, then a precision timebase is necessary. This can be achieved in a relatively simple manner, using the carrier wave signal of the 200 kHz broadcast transmitter at Droitwich.

The function of a timebase for a frequency counter is to supply various control signals of differing frequency. The unit described in the following article is designed to be TTL compatible since the timebase signals are intended to drive TTL IC's in the frequency counter.

It is possible to construct a reasonably accurate oscillator using a quartz crystal. The maximum stability of such an oscillator is in the region of 5 p.p.m./°C. However if it is to be used to calibrate another crystal oscillator, then obviously a higher order of stability is necessary. For satisfactory results the reference oscillator must have a temperature coefficient of at least .01 p.p.m./°C. This is not easily achieved with a crystal oscillator. As a result of variations in the supply voltage, changes in temperature, and ageing of components, the oscillator tends to drift off frequency.

The first of these problems can be eliminated by stabilising the power supply, and the natural ageing of components can be artificially accelerated. In practice this is done by repeatedly heating the whole circuit to a temperature of approx. 80°C and then cooling to preferably well below zero. If the components have been artificially aged in this manner further natural ageing is negligible.

The frequency drift caused by changes

in temperature is a direct consequence of using a quartz crystal. If possible therefore, the crystal should be placed in a thermostatic enclosure, i.e. a place where the temperature may be controlled with a high degree of accuracy. If all these measures are observed, a temperature stability of .01 p.p.m./°C may be achieved, however the cost of such a unit then increases dramatically.

The Alternative

Fortunately however, a much cheaper alternative is available requiring only a relatively small outlay. Since the carrier wave of broadcast transmitters is normally maintained at a constant frequency, in principle it

therefore represents a suitable 'timebase'. A carrier wave frequency which is particularly well suited to this task is provided by the 200 kHz BBC transmitter at Droitwich. The accuracy of this frequency is maintained within 7 parts in 10¹¹.

The block diagram in figure 1 shows the basic design of the timebase. The transmitter signal is first amplified and then used to control a phase locked loop (PLL). The output frequency of this loop is divided down by frequency dividers, thereby producing a number of timebase frequencies suitable for a frequency counter. The transmitter signal is picked up by a ferrite aerial (L3 in figure 2a). L3 together with C19 and capacitor C1, which is mounted on the circuit board, form a circuit tuned to 200 kHz. The received signal is amplified (approx. 250,000 times) in the selective amplifier formed by transistors T1 to T5 then fed into the PLL (IC1, type 567).

The PLL circuit 'cleans' the received signal of modulation, interference and noise, whilst maintaining the accuracy and stability of the frequency. It is necessary for the input frequency to be close to the free-running frequency of the (inbuilt) VCO, so that the VCO can lock in. This locking is indicated by LED D1 lighting up. The free-running frequency of the VCO is determined by R13, P1 and C14, P1 being used to adjust the frequency. R17, C17 and C18, together with a resistor present in the IC, form a lowpass filter, while C16, together with another IC-resistor, forms a lowpass filter for the in lock output. The output of the VCO, which is locked in phase with the input signal, is taken from pin 5. T6 forms a buffer stage which provides the signal for the divider circuit (figure 3). This divider circuit is made up of IC's IC2 to IC7 (type 7490). Each stage divides the input frequency by a factor of 10 (first by 2 and then by 5). The signals of 100 kHz (10 μs), 10 kHz (100 μs), 1 kHz (1 ms), 100 Hz (10 ms), 10 Hz (0.1 s), 1 Hz (1 s) and 0.1 Hz (5 s) are fed out as timebase frequencies.

In order to ascertain if it is Droitwich which is being picked up and not some other transmitter, the unit includes a programme output which is connected to the collector signal of T3.

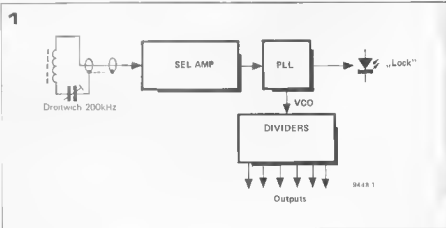

2a

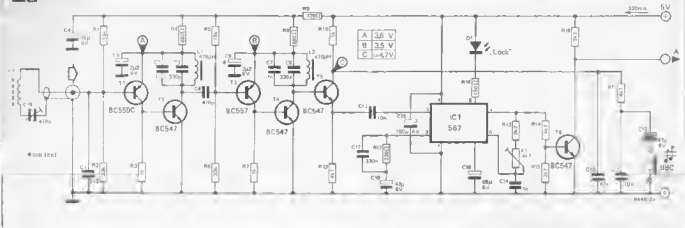

Figure 1. Block diagram of the precision timebase, consisting of a Dratch receiver with PLL and a frequency divider.

Figure 2a. Circuit diagram of the receiver, which consists of a selective amplifier feeding into a PLL.

Figure 2b. If the signal begins to clip in the second stage, two limiting diodes may be placed across the tuned circuit.

Figure 3. Circuit diagram of the frequency divider, which provides the timebase frequencies.

2b



* see text

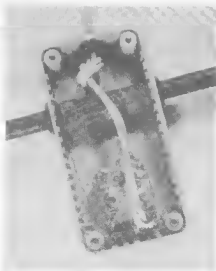

Power supply

The supply circuit uses a voltage regulator to keep the number of necessary components to a minimum. This IC should be fitted with a heatsink of about 19°C/W maximum. Capacitors C1 and C2 cut down switching spikes from the diodes. C4, in parallel with C3, is a decoupling capacitor which stops high frequency signals appearing on the supply line.

Construction

The receiver circuit and the divider circuit are mounted together on one circuit board. Figure 6 shows the printed circuit board and component

Perts list for figures 2,3 and 6

Resistors:

R1,R5 = 15 k
R2,R6 = 33 k
R3,R7,R10 = 1 k
R4,R8 = 680 Ω
R9,R17 = 220 Ω
R11,R12,R14 = 4k7
R13,R18 = 2k2
R15 = 2k7
R16 = 150 Ω
P1 = 4k7 preset

Capacitors:

C1 = 2n2
C2,C7 = 1 n 5% ceramic
C3,C8 = 330 p 5% ceramic
C4 = 16 μ/6 V
C5,C9 = 2μ2/6 V
C6 = 470 p
C10 = 47 n
C11,C13 = 10 n
C12,C18 = 47 μ/6 V
C15 = 100 μ/6 V
C16 = 68 μ/6 V
C17 = 330 n
C19 = 470 trimmer
C14 = 1 n

Inductors:

L1, L2 = 470 μH
L3 = see text and figure 5

Semiconductors

T1 = BC559C, 8C179C or equ
T2, T4, T5, T6 = BC547, BC107 or equ.
T3 = BC557, 8C177 or equ.
D1 = LED
IC1 = 567
IC2, IC3, IC4, IC5, IC6, IC7 = 7490

Miscellaneous:

earphone, e.g. crystal 2 k impedance or greater

3

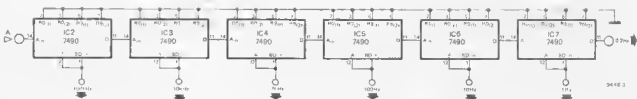

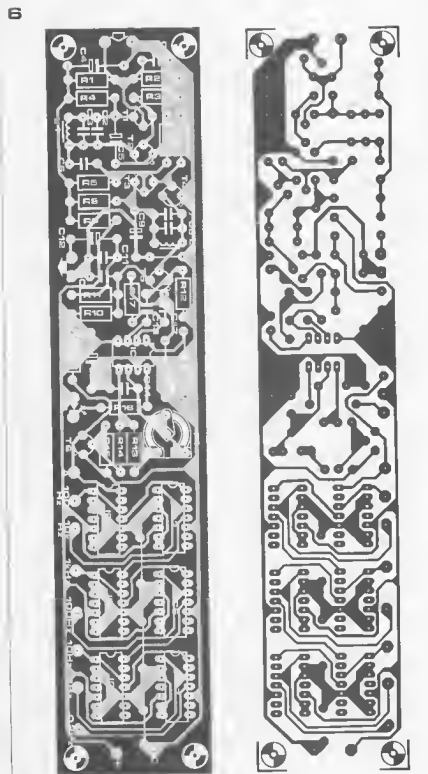
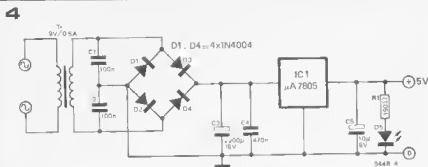

layout. A low-loss type capacitor, such as ceramic capacitors, should be chosen for C1, C2, C3, C7 and C8. The circuit board should be mounted in a metal box. Coil L3, the aerial coil proper, is wound on a ferrite rod 10 mm in diameter and 20 cm long using enamelled copper wire 0.2 mm in diameter (see figure 5). L3 and C19 should be mounted firmly in position to prevent any change in the frequency from occurring, as this circuit is highly selective.

Tuning

The circuit can be tuned with the aid of a portable radio receiver. A place in the house should be chosen where there is good reception from Droitwich, and the input circuit L3/C19 should be set up here. The aerial coil and capacitor may be connected to the Droitwich receiver by means of screened microphone cable, which should not be longer than 20 metres.

Having decided upon the best position for the aerial coil and upon the length of the cable, the receiver can now be tuned. An earphone (preferably with a screened cable) should be connected to the receiver, the trimmer capacitor C19 can then be adjusted until the Droitwich transmitter is heard on both receivers. Pre-set potentiometer P1 is then slowly adjusted until LED D1 lights up. By quickly switching the unit on and off several times, it is possible to check whether the receiver is tuned correctly. If properly tuned the LED should light up as soon as the circuit is switched on. If this is not the case then the potentiometer should be readjusted.

With strong reception the sound becomes poorer since limiting occurs in the amplifier. However this will not affect the timebase frequencies. If the field strength of Droitwich is so great that the signal begins to clip in T2, then

Parts list for figures 4 and 7

Resistors:
R1 = 150 Ω

Capacitors
C1, C2 = 100 n
C3 = 2200 μ/16 V
C4 = 470 n
C5 = 10 μ/6 V

Semiconductors:
D1, D2, D3, D4 = 1N4004
D5 = LED e.g. TIL209
IC1 = μA7805 or LM129

Miscellaneous*
Tr = mains transformer, 9 V,
0.5 secondary

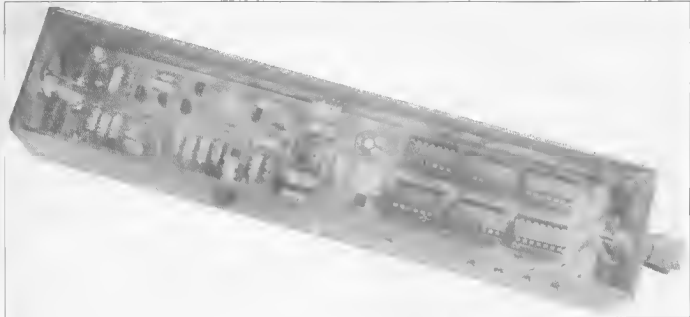

5

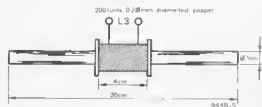

Figure 4. Diagram of the supply circuit for the Droitwich receiver. To stabilize the supply a three terminal IC voltage regulator is used.

Figure 5. Details of the aerial coil, which functions as a directional aerial. A circular cross section ferrite rod or a ferrite 'slab' may be used.

Figure 6. The printed circuit board (track pattern and component layout) for the circuit shown in figures 2 and 3. (EPS 9448)

Figure 7. Printed circuit board and component layout of the supply circuit shown in figure 4. (EPS 9448-1)

7

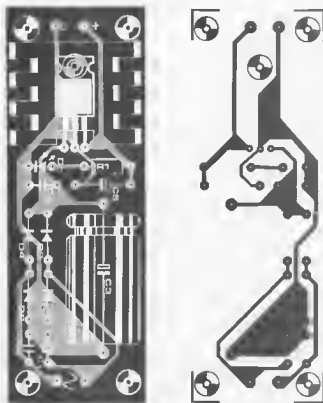

two limiting diodes may be placed across the tuned collector circuit (see figure 2b). If necessary C9 may also be omitted, which would result in a negative feedback to T3.

When mounting the aerial circuit and the receiver, it is recommended that both be kept as far away as possible from digital circuitry, since the latter can disrupt the circuit by producing spurious signals. It should also be mentioned that this unit cannot be used to drive a digital clock or similar digital equipment, since the Droitwich transmitter goes off the air for several hours every night.

Slotless model car track

(3)

Having described the multiplex encoder, infra-red transmitter and receiver in the previous two articles, the next important component in the control chain is the servo amplifier, which converts the variable width control pulses into a corresponding position of the steering servo.

Servomechanisms of the type used in model control consist of a high grade micromotor driving two control horns through a 200:1 reduction gear and a rack and pinion mechanism. A potentiometer mounted on the output of the gear train provides positional feedback information.

Figures 1a and 1b show the general appearance and internal construction of a servo. In figure 1b the motor and potentiometer can clearly be seen in the lower half of the case and the gear train in the upper half. The connecting cable terminating in a five-pin plug contains two leads for the motor supply and three leads for the potentiometer connections. Figure 2 shows a schematic representation of a servo. The function of the servo amplifier is to compare the desired position of the servo (which information is contained in the control pulse width) with the actual position of the servo as indicated by feedback from the potentiometer. The servo then applies power to the servomotor to move the servo in one direction or the other until the required and actual servo positions are the same. To conserve power current is supplied to the motor only when the servo position is to be changed (unlike some designs that require alternate current pulses of

opposite polarity to maintain a stable servo position).

Block diagram

The principle of operation of the servo system is shown in the block diagram of figure 3. Control pulses from the multiplex decoder are fed to a high input impedance non-inverting buffer stage at the input of the servo amplifier. The output of the buffer stage is connected to the trigger input of a monostable. When this is triggered by the positive-going edge of the control pulse its output goes to logic '0'. It remains in this state for a time which varies according to the position of the servo feedback potentiometer. As this potentiometer is driven by the servo gear train the monostable thus provides a reference pulse whose width is proportional to the servo position and can vary between 1 and 2 ms. The required position of the servo is thus contained in the control pulse train in the form of positive going pulses whose width can vary from 1-2 ms depending on the position of the control joystick, while the actual position of the servo is contained in a train of simultaneously negative-going pulses whose width is proportional to the actual servo position. The control pulses from the output of

the buffer stage are combined with the reference pulses from the monostable in a summing circuit, with three results:

1. If the control pulse is longer than the reference pulse the output of the summing circuit will be a positive pulse whose width is equal to the difference in width between the two pulses.
2. If the control pulse is shorter than the reference pulse the output will be a negative pulse whose width is equal to the difference between the two pulses.
3. If the pulses are equal (i.e. the servo is in the correct position) the output will be zero.

From here it is a fairly simple step to provide the required drive to the servomotor. The positive pulses can be amplified and used to drive the servo in the direction that increases the pulse length from the reference monostable, while the negative pulses are amplified and used to drive the servo in a direction which will reduce the pulse width of the reference monostable. The servo will thus always move so as to make the control pulses and reference pulses of equal width. When the servo reaches the correct position the control and reference pulses cancel and no current is fed to the servomotor. One small trick has to be employed to make the system function satisfactorily.

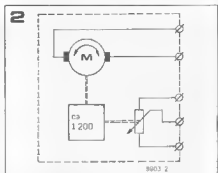
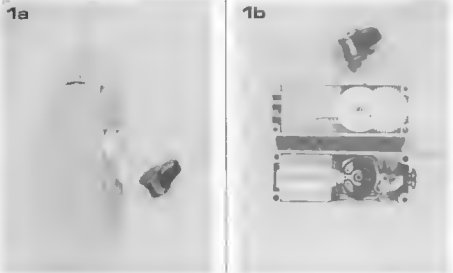
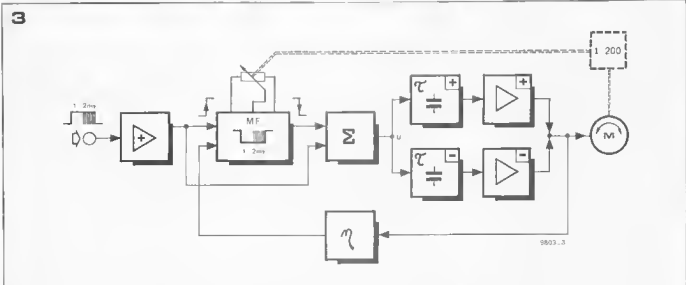

Figure 1. External and internal views of a servo.

Figure 2. Schematic representation of a servo. The feedback potentiometer is driven through a 200 : 1 reduction gear.

Figure 3. Block diagram of a servo system.



Since the control pulses occur only once every 25 ms it follows that the pulses from the summing circuit do also. If such short pulses were applied direct to the motor then motor and gear train friction and inertia would prevent the servo from responding. Pulses from the summing circuit are thus 'stored' on two capacitors, one for the positive half of the servo amplifier and one for the negative half. This voltage can be amplified and used to drive the servo even in the interval between control pulses.

Damping

The control system so far described is a purely 'on-off' feedback control system. Unfortunately this system, as it stands, will not work satisfactorily in practice. When the servo reaches the correct position power to the motor will be cut off. However, due to its mechanical inertia the motor will not stop dead but may overrun by as much as 15 revolutions. The control loop will immediately see a positional error and will reverse the motor. When the correct position is again reached power to the motor will be cut and the motor will again overrun, and so ad infinitum. The effect of this is that the servo oscillates or 'hunts' about the correct position which, while it may not be disastrous from a steering point

of view unless it is extremely pronounced, nevertheless increases power consumption since the motor is turning almost all the time.

The motor inertia can be electronically compensated by introducing a lag term into the feedback loop. This is shown as block 3 in figure 3. An output is taken from the servo amplifier and fed back to the reference monostable. When the reference pulse is longer than the control pulse the feedback makes the reference pulse shorter than it should be, so that power to the motor is cut off just before the servo reaches its correct position. When the reference pulse is shorter than the control pulse the feedback lengthens the reference pulse, and again the power is cut off just before the servo reaches the correct position. In both cases the inertia of the motor will make it overrun to the correct position.

Dead zone

Since the servo amplifier has only a finite loop gain it is not possible for the servo to assume exactly the correct position. There is always bound to be a small but finite difference between the control pulse and the reference pulse. Once the servo has moved to within a certain tolerance from the correct

position the output pulses from the summing stage become so narrow that insufficient output is available to overcome motor friction. However, these pulses can cause the motor to hum and the output transistors to overheat.

The solution is to introduce a 'dead zone' into the output amplifier. This means that the output transistors will conduct only when the driving signal exceeds a certain amplitude. Once the servo has moved sufficiently close to the required position power to the motor is completely cut off. The dead zone in the present design amounts to about one percent of the total servo travel. This means that, once the servo is within one percent of the required position power to the motor will be cut, or to put it another way the control joystick must be moved by at least one percent of its travel before the servo will respond. This accuracy is more than adequate for model control applications.

Complete circuit

Figure 5 shows the complete circuit of the servo amplifier. T1 is the input buffer stage. The differentiating network C1/R6 converts the leading edges of the control pulses into short spikes to trigger the reference monostable which

consists of T2 and T3. The basic time constant of the monostable is determined by R10 and C2. The position of the feedback potentiometer P1 varies the switchover point at which the monostable flips back into the rest state and hence varies the pulse width of the reference monostable.

Control pulses from the collector of T1 and reference pulses from the collector of T2 are summed by resistors R4 and R5, then fed to the pulse comparator stage which consists of transistors T4 and T5 together with differentiating networks C4/R14 and C5/R15. T4 and T5 are turned on by the differentiated pulses applied to their bases, and the voltages which appears at their common collectors depends on the polarity (with respect to the half supply voltage of 2.4 V) of the pulses appearing at the junction of C4 and C5.

Supply the sort time that T4 and T5 are turned on C6 and C7 are charged so that the voltage at their junction is equal to the collector voltage of T4 and T5. This voltage is stored on C6 and C7 even after T4 and T5 have turned off, and is used to drive the output stage during the interval between control pulses.

The output stage consists of two halves comprising T6/T8 and T7/T9 respectively. This arrangement is basically a class B amplifier. When the voltage at the junction of C6 and C7 exceeds 2.4 V by the V_{be} of T6 (about 0.7 V) T6 will turn on, turning on T8 which will drive the motor in one direction. When the voltage is more than 0.7 V below 2.4 V T7 will turn on, turning on T9 which will drive the motor in the opposite direction. Between these two voltages there is a dead zone where all four transistors are turned off.

Damping is provided by the integrating network R21/C8. Depending on the direction of travel of the servo this provides a compensating voltage to either lengthen or shorten the reference pulse so that the servomotor is switched off just before reaching the desired position, thus preventing overshoot and hunting.

Application notes

The servo amplifier can be used with the Elektor system, or with many commercial 'digi-proportional' remote control systems. Some of these systems, however, use a pulse width range of 1 to 1.5 ms instead of 1 to 2 ms. The pulse width range is thus half that of the Elektor system, and the movement of the servo would thus also be halved if the Elektor servo amplifier were used unmodified. Fortunately the problem is easily overcome by reducing the effect of P1 so that a range of 1 to 1.5 ms is obtained from the reference monostable over the entire servo travel.

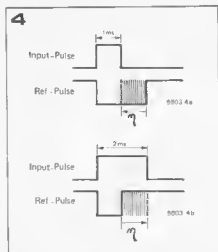

Figure 4. The servomotor is driven until the control and reference pulses are of equal length, when the servo will be in the required position. Since the servomotor will tend to overrun after it is switched off, damping is provided which artificially lengthens or shortens the reference pulse. The motor will thus be switched off just before reaching the correct position, and the servo will 'coast' to the correct position.

Figure 5. Complete circuit of the servo system.

Figures 6 to 12b. Circuit waveforms of the servo amplifier. For description see text.

Figure 13. Printed circuit board and component layout for the servo amplifier. (EPS 9803)

This is accomplished by increasing the value of resistors R8 and R16 to 10 k. The damping of the servo amplifier must also be matched to the servo-mechanism used, since different servos will have different amounts of overrun. Any servo can be matched to the amplifier by altering the value of R22, which may be varied between 180 k and 680 k to suit the servo used. The value of R22 is correct when the servo is 'critically damped'. This means that if the control position is suddenly changed the servo will move to the new position as quickly as possible without overshoot. If the servo is underdamped then hunting will occur, whilst if it is overdamped the response will be sluggish.

Circuit waveforms

The oscillographs shown in figures 6 to 12b illustrate the operation of the servo. Figure 6 shows the control pulse waveform (upper trace), and the reference monostable output (lower trace). These pulses appear to be the same length, (about 1.5 ms) but expanding the trace in a horizontal direction shows that the reference pulse is in fact slightly longer than the control pulse (figure 7).

Figure 8 shows the operation of the pulse comparator when the control and reference signals are of equal length. The upper trace is the waveform at the junction of R4 and R5. Since R4 and R5 are not perfectly matched there are some small negative-going pulses on this trace, but these are too small to turn on T4 or T5. This is shown by the lower trace, which is the waveform at the junction of C6 and C7. The voltage here remains at the half supply potential of +2.4 V.

Figure 9 illustrates the action of the pulse comparator when the reference pulses are longer than the control pulses. This can be seen as the very short negative going spikes on the upper trace. The voltage at the junction of C6 and C7 now rises above 2.4 V, turning on the upper half of the output stage. As might be expected, figure 10 illustrates the action of the pulse comparator when the reference pulses are

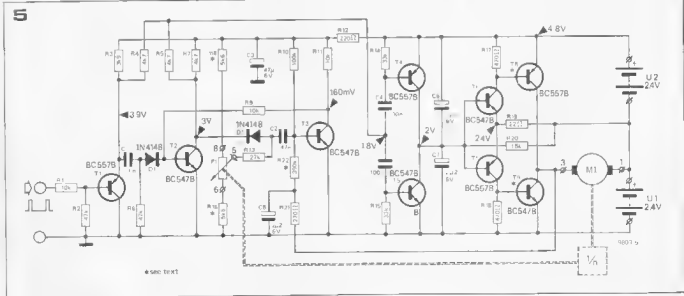

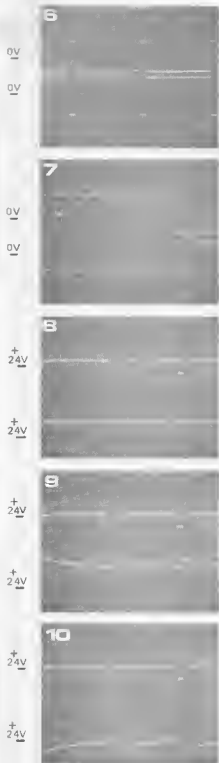

shorter than the control pulses. The waveform at the junction of R4 and R5 exhibits positive-going spikes. The voltage at the junction of C6 and C7 falls below 2.4 V, turning on the lower half of the output stage.

Figures 11a to 12b show what happens when the control and reference pulses are almost equal. Figure 11a shows a reference pulse (lower trace) that is only 40 μ s longer than the control pulse. The lower trace in figure 11b shows that the voltage at the junction of C6 and C7 does not have time to reach its correct value since T4 and T5 are turned on for only a short time. The input voltage to the output stage thus decays quickly and the output stage is turned on for only part of the interval

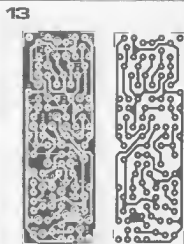

Parts list to figures 5 and 13.

Resistors.

R1, R9, R11 = 10 k
 R2, R6 = 47 k
 R3 = 3k9
 R4, R5, R7 = 4k7
 R8, R16 = 5k6
 R10 = 100 k
 R12 = 220 Ω
 R13 = 27 k
 R14, R15 = 33 k
 R17, R18 = 470 Ω
 R19 = 22 Ω
 R20 = 18 k
 R21 = 270 Ω
 R22 = 390 k

Capacitors:

C1 = 10 n ceramic
 C2 = 47 n MKM
 C3 = 47 μ /6 V tantalum
 C4, C5 = 100 n ceramic
 C6, C7, C8 = 2 μ /2.6 V tantalum

Semiconductors:

T1, T4, T7 = 8C 557 8
 T2, T3, T5, T6 = BC 547 8
 T8 = BC 557 8 (AC 188)
 T9 = 8C 547 B (AC 187)
 D1, D2 = 1N4148

Miscellaneous:

M1, P1 = control servo with built-in potentiometer

between control pulses.

Figures 12a and 12b illustrate the same situation, but in this case the reference pulses are slightly shorter than the control pulses.

These waveforms should serve to illustrate the operation of the servo amplifier, and will act as a guide to any faultfinding (which hopefully should not be necessary).

Construction

As the servo amplifier has to fit inside a small car (or other model) the construction is necessarily extremely miniature, and the p.c. board and component layout are shown in figure 13. A miniature soldering iron and 22 SWG solder should be used. Resistors should prefer-

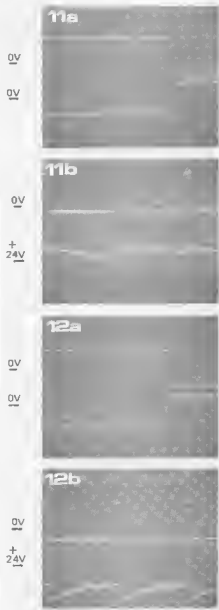

ably be 1/8 W. Construction should be commenced by mounting all the semi-conductors, pushing the transistors into the holes as far as possible. Next the capacitors may be mounted, and finally the resistors, which are stood on end. To obtain the neatest results it is advisable to mount the components one at a time and solder and trim the leads before mounting the next component. The numbered connections to the servo potentiometer and motor refer to servos manufactured by Graupner. Other types of servos may be numbered differently. Most servos use a 5 k feedback potentiometer, but there are some which use a 1 k pot. For use with these servos the values of R8 and R16 should be altered to 1k2. If desired, transistors T8 and T9 can be germanium types AC 188 and AC 187, since these have a lower saturation voltage than silicon types.

levitator

In view of the current interest in magnetic levitation for applications such as hovertrains (see Elektor 22 p. 2-08) it was felt that a magnetic levitator would make an interesting laboratory demonstration for students. The practical difficulties of cryogenic engineering and the fate of the brass monkey led to the abandonment of the superconducting approach at an early stage of development, and the system finally decided upon was controlled ferromagnetic attraction. The system provides an amusing demonstration and an interesting introduction to feedback control systems.

In order to levitate an object it is necessary to balance gravitational attraction with an equal and opposite force. Anyone who has ever played with permanent magnets will know that it is possible to lift a ferromagnetic object with a magnet.

Controlled levitation, however, is a different matter. For the object to float in a stable position it is necessary for the gravitational force to be balanced precisely by the attractive force of the magnet. Since the force between the magnet and the object varies as the inverse square of the distance between them it is fairly easy to see what will happen. If the object is initially placed in such a position that the magnetic attraction is weaker than the gravitational attraction then the object will tend to fall away from the magnet. As it does so the magnetic force will become weaker, so the object will fall even further, and the magnetic force will become weaker still. If, on the other hand, the object is placed so that the magnetic force is stronger than the gravitational force the object will be attracted upwards. The magnetic force will become even stronger, so the object will be attracted to the magnet even more, until it finally contacts the magnet. Only if the magnetic and gravitational forces are exactly balanced will the object remain in position, and even then any slight disturbance will send it either up or down. In other words, the system is unstable.

To make the system stable a positional feedback control system is required, which adjusts the strength of the magnet according to the position of the object. If the object moves close to the magnet then the field strength of the

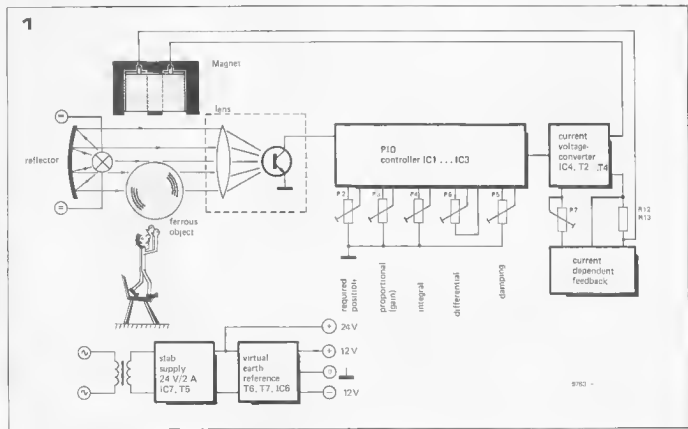

magnet is reduced. If the object tends to fall away from the magnet then the field strength of the magnet is increased. The object will thus assume an equilibrium position where the magnetic and gravitational forces are exactly balanced. If the object is displaced from this position by some external force then it will return automatically, i.e. the system will be stable.

System block diagram

Obviously the two prime requirements of the system are a magnet whose field strength can be varied, and some means of sensing the position of the object. The first criterion is fulfilled by an electromagnet or solenoid, whose field strength can be altered by varying the current passing through the coil. Since there must be no physical contact with the object the second criterion is probably best met by a photoelectric system. The object moves across a beam of light which is focused onto a phototransistor. As it moves closer to the magnet it obscures more and more of the light. The phototransistor current thus varies in sympathy with the position of the object.

A block diagram of the system is given in figure 1, and illustrates the general setup of the electromagnet and optical system. Without going into the finer points of the electronics at this stage, suffice it to say that if the object tends to fall then the amount of light falling on the phototransistor will increase and the phototransistor current will increase. This will cause a corresponding increase in the electromagnet current and the attractive force will increase, thus pulling the object upwards. If the

3

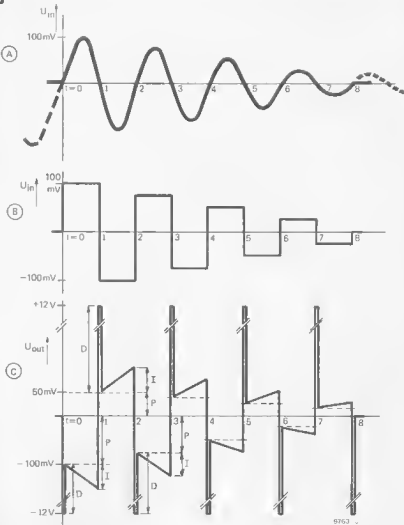

Figure 1. Block diagram of electromagnetic levitator using a three-term positional feedback controller.

Figure 2. Modified mains transformer used as an electromagnet.

Figure 3. Simplified waveforms showing how the object returns to the rest position after a displacement.

2



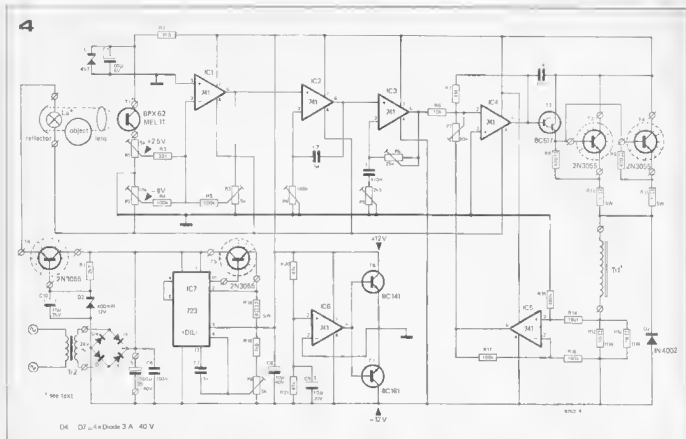
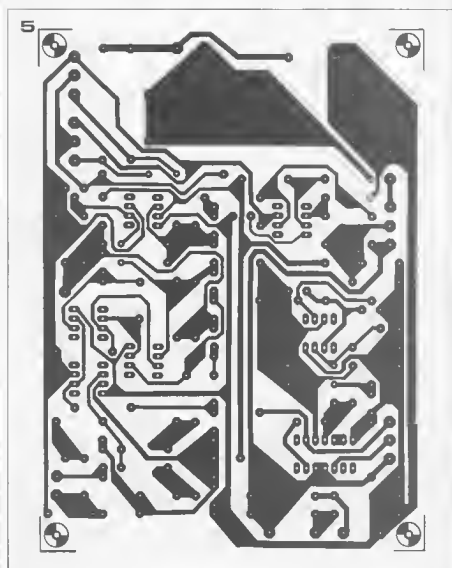

Figure 4. Complete circuit of the levitator.

Figure 5 Printed circuit board and component layout of the levitator. (EPS 9763)



Parts list.

Resistors

R1 = 2k7
 R2 = 1k5
 R3 = 33 k
 R4, R5, R14, R15,
 R16, R17 = 100 k
 R6 = 10 k
 R7 = 1 M
 R8, R9 = 470 Ω
 R10, R11 = 1 Ω /5 watt
 R12, R13 = 10 Ω /11 watt
 R18 = 0 Ω /22/5 watt
 R19 = 1k8
 R20, R21 = 47 k
 P1, P3, P8 = 5 k (4k7) trimmer
 P2 = 10 k trimmer
 P4 = 100 k trimmer
 P5 = 2k5 (2k2) trimmer
 P6 = 25 k (22 k) trimmer
 P7 = 50 k (47 k) trimmer

Capacitors

C1 = 100 μ /6 V
 C2 = 1 μ
 C3 = 470 n
 C4, C6 = 100 n
 C5 = 2500 μ /35-40 V
 C7 = 1 n
 C8 = 10 μ /40 V
 C9 = 10 μ /30 V, tantalum
 C10 = 10 μ /25 V

Semiconductors:

T1 = BPY 61, BPY 62, BPX 62,
 MEL 11 or equivalent
 T2 = BC 517
 T3, T4, T5, T8 = 2N3055
 T6 = BC 141
 T7 = BC 161
 D1 = 4V7/400 mW, zener
 D2 = 1N4002
 D3 = 12 V/400 mW, zener
 D4... D7 = Si-diode 3 A/40 V
 IC1... IC6 = 741
 IC7 = 723

Miscellaneous:

LA = 12 V/1 W bulb mounted in
 reflector (torch)
 Convex lens of approx 100 mm
 focal length
 Tr1 = rebuilt mains transformer
 (see text)
 Tr2 = mains transformer
 24 V/3 A secondary

object tends to rise the reverse occurs. The light falling on the phototransistor decreases, hence so does the attractive force.

Mechanical details

Before proceeding with the circuit description it may be worth while further to discuss the mechanical details of the electromagnet and optical system.

1. The object must obviously be made of ferromagnetic material, e.g. iron, nickel, cobalt or a combination of these such as ferrous steel (not stainless steel). 2. The object should be fairly light in weight so that it can float at a reasonable distance from the solenoid without the need for an excessively strong solenoid.

3. The object should have a cross-sectional area sufficient completely to obscure the light beam.

Hollow containers such as shoe polish or tobacco tins meet these requirements admirably.

4. The light source in the prototype was simply a cheap torch with a reflector diameter of about 40 mm. The bulb was removed and replaced by a 12 V/1 W (or greater wattage) bulb, which is powered from the system's mains power supply. The light sensor can be made from a cheap 50 mm magnifier, as available from most large stationers, and a piece of PVC drainpipe to suit the diameter of the lens. The phototransistor is placed at the principle focus of the lens. To find the approximate focal length of the lens focus the image of a distant light source such as the sun to a spot on a piece of paper, then measure the distance between the paper and the lens. Alternatively a commercial light source/sensor could be used, but it must be fitted with a phototransistor, not an LDR.

5. The electromagnet can be made from a mains transformer which must have 'E' and 'I' laminations, and should have a secondary rating of about 60 V/2 A. The laminations are taken apart and the 'I' stack are discarded. The 'E' laminations are then reassembled so that they all face in the same direction, as shown in figure 2. The secondary of the transformer now becomes the coil of the electromagnet.

Alternatively, the solenoid can be purpose-made using ferrite 'E' cores with a winding of 1,500 turns of 0.2 mm enamelled copper wire. Depending on the core size used levitation distances of several centimetres can be obtained with such a purpose-built solenoid.

Control system

The positional feedback control system is a three-term, proportional plus integral plus differential control system, shown as the central block in figure 1. The controller is provided with five potentiometers that control respectively the desired position of the object, system gain (proportional term), integral term, differential term and damping. The system compares the desired pos-

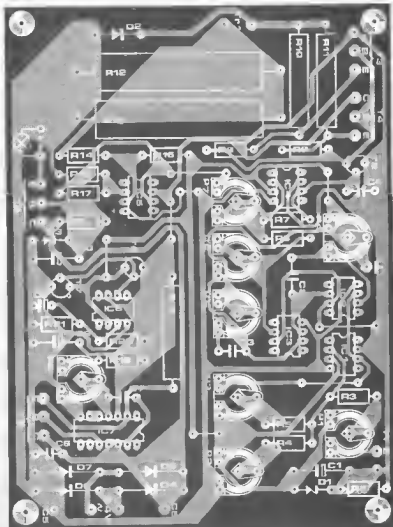

tion of the object, represented by the slider voltage of P2, with the actual position information from the phototransistor and produces an error voltage to drive the solenoid. As the field strength of the solenoid is current dependent a voltage-current converter at the controller output converts the controller output voltage into a proportional current.

Although it is beyond the scope of this article to attempt a detailed mathematical analysis of a three-term feedback control system the general principles are fairly simple to grasp.

Proportional term

When the object is not in the desired position then the reference voltage provided by P2 is obviously different from the feedback voltage from the phototransistor. This difference is known as an error voltage, since it represents the positional error. This error voltage is amplified and used to drive the electromagnet to provide a restoring force which tends to return the object to the correct position. Obviously, the closer the object gets to the correct position the smaller is the error voltage and hence the restoring force, so that, unless the error voltage is amplified an infinite amount the object can never achieve exactly the correct position. This is where the integral term comes in.

Integral term

This integrates the error voltage over a period of time. The integrator output will thus ramp positive or negative depending on the polarity of the error voltage. The integrator output is added to the proportional output and also drives the solenoid. When the object is in exactly the correct position and the error voltage is zero then the integrator output will remain constant. In fact, in this condition the only restoring force is that provided by the integrator output.

Differential term

The differential term enables the control system to respond rapidly to any sudden displacement of the object. If this occurs then there will be a sharp step in the error voltage. The differential of the error voltage is simply its slope. Since the leading edge of the step has an extremely large slope (in theory infinite), the differentiator output will be a large, very short spike. The differentiator output is added to the integral and proportional terms and provides an initial large 'kick' to send the object in the right direction. However, if the differential output is too large it can cause the object to go too far and overshoot the correct position. This can cause the system to become unstable when the object will oscillate about the correct position with ever increasing amplitude until it finally falls to the ground.

To overcome this problem a damping control P5 is provided, which limits the differential term.

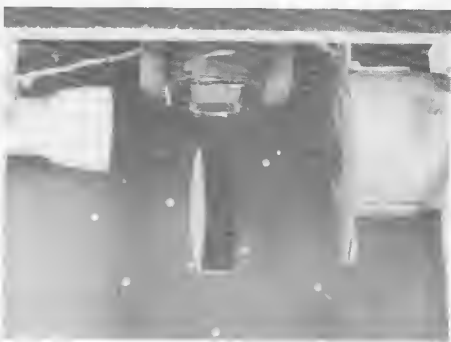

The operation of the complete system may perhaps better be understood by reference to figure 3. If the object is displaced from the rest position and released then (depending on the degree of damping) it will oscillate about the rest position with a damped sinusoidal motion. Figure 3a shows the error voltage which decays in a similar fashion. In order that the action of the three terms may more easily be understood, this is simplified to a damped squarewave oscillation in figure 3b. Figure 3c shows the PID output corresponding to this. The differential term can easily be recognised as the short positive and negative spikes. The integral term can be recognised as the positive and negative-going ramps, while the proportional term is simply the continuous level of the waveform.

Complete circuit

The complete circuit of the levitator is given in figure 4. The power supply circuit occupies the lower left-hand corner of the diagram. A 723 regulator IC with an external series pass transistor (T5) is used to provide a stabilised supply of 24 V at up to 3 A. A simple zener and transistor stabiliser D3/T8 provides a 12 V supply for the lamp. A zero volt reference for the op amps is provided by IC6, T6 and T7.

The proportional term of the controller is provided by IC1. This is simply an inverting amplifier with a summing input. The phototransistor current produces a voltage drop across P1 and a proportional current flows through R3 into the op amp. A reference voltage is provided by P2, and a proportional (negative) current flows through R4. The output of the op amp is a voltage which is proportional to the difference between these two currents, and thus obviously depends on the setting of the reference potentiometer, the position of the object (and hence the phototransistor current) and the setting of the gain

potentiometer P3. When the object is in the desired position then the currents through R3 and R4 will be equal and the output voltage of IC1 will be zero.

To sum up, IC1 produces a DC error voltage proportional to the displacement of the object from the correct position.

The integral term of the controller is provided by IC2. Any output voltage from IC1 will cause a corresponding voltage to appear across P4.

Since this voltage must cause a current to flow, which cannot come from the op amp input, a current must flow from the op amp output into C2, thus charging it. No matter how small the error voltage from IC1, a current will flow into C2, slowly charging it up. The output of IC2 will thus ramp positive or negative depending on the polarity of the error voltage. Only when the error voltage is exactly zero will C2 cease charging.

The integral term is thus responsible for the ultimate positional resolution of the system, since it will, over a period of time, integrate an error voltage, no matter how small, into a much larger voltage.

Since the output voltage of IC2 is equal to the voltage across C2 plus the voltage across P4 (which is equal to the error voltage) the output of IC2 is equal to the sum of the proportional and integral terms of the controller.

The differential term of the controller is provided by IC3. If the object is suddenly displaced an error voltage step will immediately appear at the output of IC1, and hence at the output of IC2. By definition this voltage must immediately appear (or try to appear) at the inverting input of IC3, i.e. across C3. The output of IC3 must thus swing either positive or negative (depending on the polarity of the input voltage) to charge C3 via P6. Since C3 must charge as quickly as possible the output of IC3 will swing hard against either the positive or negative supply rail.

To look at it another way, assuming P5 is set to zero the closed loop gain of IC3 is given by

$$\frac{P_8 + X_{C3}}{X_{C3}}$$

As far as the input voltage is concerned, C3 initially presents a very low impedance, so the closed loop gain of IC3 is very high and the output will saturate in response to a small step input. However, once C3 has charged IC3 simply acts as a voltage follower and the output is simply equal to the steady state input voltage, i.e. the sum of the integral and proportional terms. P5 introduces resistance in series with C3 and damps the response of the differentiator. Without P5 the system would be unstable.

The function of the differentiator is to amplify the leading edge of the step error voltage by a large amount to make the system respond quickly to any displacement of the levitated object.

Voltage-current converter

The output voltage of the PID controller is converted into a current to drive the electromagnet by the voltage-controlled current source comprising IC4, IC5, T2, T3 and T4. Basically it consists of a power amplifier consisting of IC4 and the three transistors. IC5 monitors the voltage across R12 and R13, which is proportional to the current through Tr1, and thus provides current-dependent negative feedback.

Construction

A printed circuit board and component layout for the levitator circuit are given in figure 5, and the construction should pose no problems. Potentiometers P2 to P6 may be presets, or leads may be brought out to normal potentiometers so that easy adjustment of the circuit parameters is possible for demonstration purposes. T3 and T8 should be mounted on heatsinks of not less than 3°C/W thermal resistance.

Adjustment

Sockets should be provided for mounting IC1 to IC5 and initially only IC6 and IC7 should be mounted on the board. Set all presets to their mid-positions. Power can now be applied and P8 adjusted until the collector emitter voltage of T6 is exactly 12 V. P2 should now be adjusted until the slider voltage of P2 is -8 V with respect to ground. The other ICs can now be plugged into their sockets.

The object can now be placed in the light beam and P1 be adjusted until the object is attracted to the electromagnet. It will usually begin to oscillate violently. This can be controlled by adjustment of the damping potentiometer P5 and the gain potentiometer P3. Further improvement may be effected by adjustment of the integral and differential controls P4 and P6, and by the voltage-current converter feedback potentiometer P7. The effect of these various controls is obviously a matter for experiment.

an invitation to investigate,
improve on and implement
imperfect but interesting ideas.



Active filters for the 'filler driver' principle

A loudspeaker 'crossover' filter invariably consists of a pair of complementary Butterworth-characteristic circuits, with stop-band slope of 12 or 18 dB per octave. The phase-characteristic of the complete system can be improved by adding a 'filler driver' channel.

The filler driver principle introduced by the Danish company of 'B & O' adds an extra loudspeaker for each crossover in the system. The extra unit is only driven in a narrow range of frequencies, by means of an extra filter section.

The active selective filters given here will enable this extension to be applied to the 'active crossover filter' described elsewhere in this issue.

The response of a Butterworth-type second order low-pass filter is given by:

$$\frac{v_l}{v_i} = \frac{1}{1 + \sqrt{2}P + P^2} \quad (1)$$

in which P is the complex normalised

frequency $j\frac{\omega}{\omega_0}$. When f_0 is the cutoff (and crossover) frequency, then ω_0 is $2\pi f_0$.

The complementary high-pass response is:

$$\frac{v_h}{v_i} = \frac{P^2}{1 + \sqrt{2}P + P^2} \quad (2)$$

The sum of the responses (1) and (2) is:

$$\frac{v_l + v_h}{v_i} = \frac{1 + P^2}{1 + \sqrt{2}P + P^2} \quad (3)$$

Now, if we can make an additional filter with the response:

$$\frac{v_f}{v_i} = 1 - \frac{v_l + v_h}{v_i} = \frac{\sqrt{2}P}{1 + \sqrt{2}P + P^2} \quad (4)$$

then the sum total will become:

$$\frac{v_l + v_f + v_h}{v_i} = 1$$

so that we will have a 'constant voltage' filter.

A similar set of formulae can be derived for the third-order Butterworth case:

$$\frac{v_l}{v_i} = \frac{1}{1 + 2P + 2P^2 + P^3} \quad (5)$$

$$\frac{v_h}{v_i} = \frac{P^3}{1 + 2P + 2P^2 + P^3} \quad (6)$$

so that:

$$\frac{v_l + v_h}{v_i} = \frac{1 + P^3}{1 + 2P + 2P^2 + P^3} \quad (7)$$

leading to:

$$\frac{v_f}{v_i} = 1 - \frac{v_l + v_h}{v_i} = \frac{2P + 2P^2}{1 + 2P + 2P^2 + P^3} =$$

$$= \frac{2P(1 + P)}{(1 + P)(1 + P + P^2)} = \frac{2P}{1 + P + P^2}$$

for the desired 'filler' (8)

We once again find that:

$$\frac{v_l + v_f + v_h}{v_i} = 1$$

The generalised transfer characteristic

1

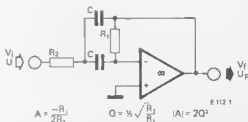

$$A = \frac{-R_1}{R_2} \quad Q = \frac{1}{\sqrt{2}} \frac{R_1}{R_2} \quad |A| = 2Q^2$$

$$f_0 = \frac{1}{2\pi C \sqrt{R_1 R_2}}$$

2a

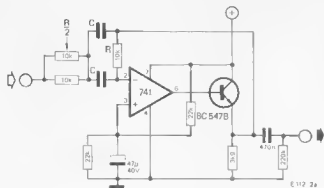

$$A = -1, Q = \frac{1}{2}\sqrt{2}$$

$$f = f_1 \text{ resp. } f_2 = \frac{1}{\pi RC\sqrt{2}}; C = \frac{22508}{f} \text{ [Hz, nF]}$$

2b

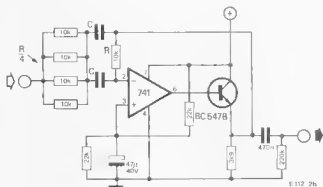

$$A = -2, Q = 1$$

$$f = f_1 \text{ resp. } f_2 = \frac{1}{\pi RC}; C = \frac{31830}{f} \text{ [Hz, nF]}$$

3

EPS 9786

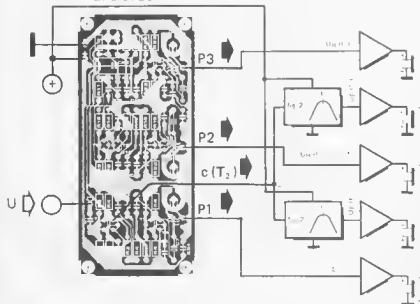

for a selective filter is:

$$\frac{v_f}{v_i} = A \frac{\frac{P}{Q}}{1 + \frac{P}{Q} + P^2} \quad (9)$$

In this case, the complex frequency

$$P = j \frac{\omega}{\omega_0}$$

will be normalised to the central frequency $f_0 = \omega_0/2\pi$. The filter gain at f_0 is A and the filter 'quality factor' is Q .

A comparison of (4) with (9) shows us that the filter we need will have $A = 1$ and $Q = 1/\sqrt{2}$, in order to 'fill up' a second-order Butterworth filter. Comparison of (8) and (9) will similarly show that the third-order case requires $A = 2$ and $Q = 1$.

Figure 1 shows a filter circuit suitable for our application, along with the formulae that produce the component values as function of A , f_0 and Q . Figure 2a shows the circuit worked out for a second and figure 2b for a third-order filter, producing 12 dB and 18 dB per octave respectively. The complete circuit of figure 3 shows that the 'main' loudspeakers are to be connected mutually in-phase, with the 'filler' inverted to compensate the 180° phase shift introduced by the selective filter.

The input to whichever selective filter is used, should be taken from the output of the buffer amplifier (built up around T_1 and T_2) on the p.c. board of the active crossover filter (see 'active crossover filters', figure 5). This connection is actually the collector of T_2 . Note once again that figure 2a is the circuit to use with 12 dB/octave filters and figure 2b the one for the case of 18 dB/octave crossover slope. ■

Bibliography

1. *Electronic crossover filters, elsewhere in this issue.*
2. *Loudspeakers — the missing link.* Paper by E. Baekgaard at the AES 50th Convention, London 1975.
3. *Aktive filter, 3. Teil.* U. Tietze & C. Schenk. *Elektronik, Heft 12, 1970.*

Have you ever spent a quarter of an hour or more looking for a fault in transistorised equipment before finding that one of the fuses was blown?

Or are you one of those people who like to have warning lamps to indicate every possible fault?

In either case, the circuit on the inside of this month's mailing wrapper might be worth looking at...

active loudspeaker= crossover filters

(2)

The first part of this article dealt with the design considerations concerning loudspeaker crossover filters in general, and active crossover filters in particular. This month a practical circuit is given, with details on how to modify it according to personal taste.

As explained last month, several decisions must be made before starting with the actual design of any loudspeaker crossover filter system. In chronological order:

- What type of filters: active only, hybrid or passive? This article only deals with filters that are active, at least in part.
- What type of system, three-way or two-way? This decision will be based on such factors as desired cabinet size, available financial resources, desired frequency range and personal taste.
- Which speakers? This depends in part on the answer to the previous question.
- What crossover frequencies, and how steep the filters? These decisions are both based on the answer to the previous question.
- Which amplifiers? This is a source of endless discussion, but the answer

obviously depends in part on the type of system and the speakers used. The points of interest in this article are the design decisions for the filter proper: two-way or three-way, what crossover frequency or frequencies, and how steep? These points are illustrated in figure 1f. If a two-way system is required, the crossover frequency is assumed to be f_1 - f_2 can be ignored. For a three-way system, f_1 is the lower crossover frequency and f_2 is the higher. The filter slopes can be 6-, 12- or 18 dB/octave, and the 12- and 18 dB/octave slopes are numbered in figure 1f.

As an example, a three-way system with crossover frequencies of 400 Hz and 4 kHz and filter slopes of 12 dB/octave at the lower crossover point and 18 dB/octave at the higher frequency can now be defined briefly as 'f1 = 400 Hz, f2 = 4 kHz, filter slopes 1, 4, 6 and 7'. This shorthand notation

will be used extensively in the tables given in this article.

The most complex circuit diagram is given in figure 5: a three-way system with all slopes 18 dB/octave. This corresponds to the figure 6 layouts for printed circuit board and parts.

When any less-complex set up is to be assembled it will only be necessary to complete the 'through paths' with wire links on the printed circuit board. This will be illustrated in detail further on.

For added convenience, all the circuits and parts-layouts have been duplicated several times - each time showing the simplified schemes and jumper wires needed for the less complex filters. The schemes we have chosen to illustrate are:

- Three-way system with 12 dB/octave slopes (figures 7 & 8).
- Two-way system with 18 dB/octave slopes (figures 9 & 10).
- Two-way system with 12 dB/octave slopes (figures 11 & 12).
- Two-way system with 6 dB/octave slopes (figures 13 & 14).

The frequency responses of the figure 5 filter set are plotted in figure 15. Figure 16 gives the plots for the figure 7 circuit. In both cases the frequencies chosen for illustration are 500 Hz (f_1) and 5 kHz (f_2).

Design procedure

The suggested procedure for finding the required design is as follows. First of all decide, using figure 1f or table 1, which set of filter characteristics is to be realised - and which crossover frequencies (values of f_1 and f_2) are to be taken. Table 2 may now be used as a kind of 'railway timetable' to determine which PC board positions are to be left open, which positions must be bridged by a jumper wire and which of the tables 3...8 is to be referred to for the component values. The examples given will illustrate this.

Loudspeaker connections

In just the same way as with passive filters it is important to connect the individual loudspeakers in the correct relative phases. The rules are as follows:

- When the filter provides a three-way symmetrical crossover with 12 dB/octave slopes, the midrange unit should be connected in opposite sense to the woofer and tweeter. Both systems of a stereo pair should of course be identically wired.

⊕	⊖	⊕
L	M	H
⊖	⊕	⊖

1f

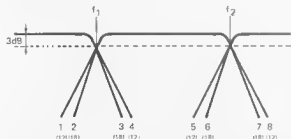

9786 11

Figure 1f. A few frequency-response plots, with slopes of 12 and 18 dB/octave and one or two crossovers, as an aid to interpretation of table 1.

15

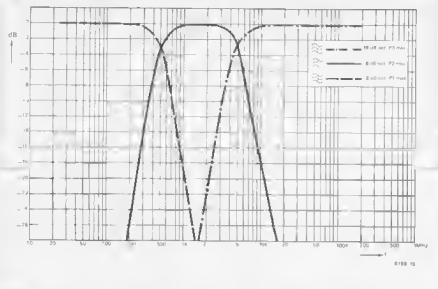

16

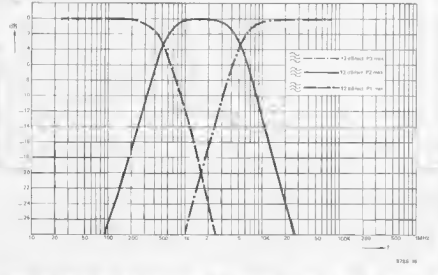

When the filter provides a symmetrical two-way crossover with 12 dB/octave slopes, the tweeter should be connected in opposite sense to the woofer-midrange unit



The problem is different with 18 dB/octave and 6 dB/octave slopes, where the phase shift in the filters at crossover totals 270° or 90°. It is convenient to connect all speakers in the same sense in these cases.

The loudspeaker-coupling electrolytic capacitors in the midrange and treble channels can in principle be given a smaller value than that in the woofer channel, thus saving space and cost. However, one must bear in mind that a smaller value component will have a lower alternating current ('ripple') rating. The smallest value that still has a current rating at least equal to the loudspeaker maximum RMS current will usually have a large enough capacitance too. In case of doubt ensure that the RC cutoff point of the

capacitor with the loudspeaker's nominal impedance is 3...5 times lower than the high-pass crossover frequency in the channel concerned. The factor 3...5 should also be observed with the woofer! This results in the well-known rule of thumb:

$$C = \frac{10^5}{f_c} \text{ (}\mu\text{F)},$$

where f_c is the lower crossover frequency.

Nothing useful is gained (and there is a risk of too much phase shift or amplitude rolloff being caused) by also reducing the values of the input coupling capacitors of the midrange and treble amplifiers. C16 and C21 in the filter are 'unnecessarily large' for the same reason. One final remark concerns the function of the presets P1, P2 and P3. These are not intended as tone control adjustments! They should be used only to compensate for possibly unequal sensitivities of the individual amplifier-speaker channels. Deliberate maladjustments of not more than 3 dB (tone controls after all!) may however occasionally be permissible.

Component list for figures 5 and 6.

Resistors:

R1,R2	= 220 k
R3,R8,R14	
R19 ¹ ,R24 ¹	= 5k6
R4,R9,R15	
R20 ¹ ,R25 ¹	= 2k2
R5 ²	see table 3
R6 ³	see table 3 or 5
R7	see table 3, 5 or 7
R10 ⁴	see table 4
R11 ⁵	see table 4 or 6
R12,R13	see table 4, 6 or 8
R16 ^{4,6}	see table 3
R17 ^{3,6} ,R18 ¹	see table 3 or 5
R21 ^{1,4} ,R26 ¹	see table 4
R22 ¹ ,R23 ¹ ,R26 ¹	see table 4 or 6
P1,P2,P3 ¹	10 k preset

Capacitors:

C1	= 470 n
C2,C6,C11	
C15 ¹ ,C20 ¹	= 4n7
C3 ¹	see table 3
C4 ²	see table 3 or 5
C5	see table 3, 5 or 7
C7,C16,C21 ¹	= 10 μ/25 V
C8 ²	see table 4
C9 ³	see table 4 or 6
C10	see table 4, 6 or 8
C12 ^{1,4}	see table 3
C13 ⁶ ,C14 ¹	see table 3 or 5
C17 ^{1,2}	see table 4
C18 ¹ ,C19 ¹	see table 4 or 6
C22	= 100 μ/40 V
C23,C24,C25	
C26 ¹ ,C27 ¹	= 100 n

Semiconductors:

T1,T3,T5,T7 ¹ , T9 ¹	BC107 B, BC547 B or equivalent
T2,T4,T6,T8 ¹ , T10 ¹	BC177 B, BC557 B or equivalent

Footnotes

- 1 means: omit part for two way filter set
 - 2 means: replace by wire link for 12 dB/oct and 6 dB/oct.
 - 3 means: replace by wire link for 6 dB/oct.
 - 4 means: omit this part for 12 dB/oct or 6 dB/oct.
 - 5 means: omit this part for 6 dB/oct.
 - 6 means: replace by wire link for two-way filter set.
- NB. The 6 dB/octave slopes are only useful in a very limited number of two-way system designs—the tables therefore do not give values for three way design.

Figure 15. Frequency response of the figure 5 circuit, as measured with f1 set at 500 Hz and f2 at 5 kHz.

Figure 16. Frequency response of the figure 7 circuit with the same crossover points as figure 15.

Figure 5. Complete circuit diagram of an active filter set for two symmetrical 18 dB/octave crossovers (three-way).

Figure 6. Component layout and p.e. board copper-side plan for the figure 5 circuit. (EPS 9786)

5

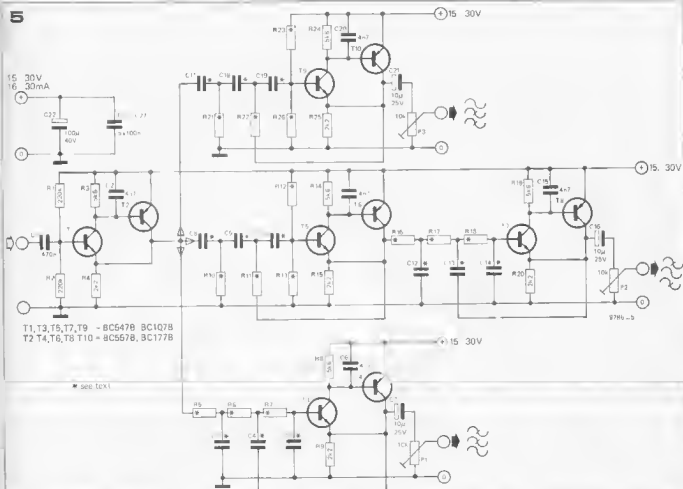

6

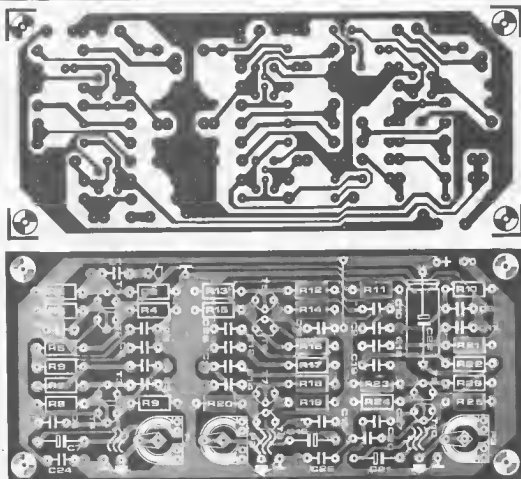

Table 1.

The different possible combinations of symmetrical or asymmetrical crossovers and 12 or 18 dB/octave slopes

filters slopes at f_1 to be	filters slopes at f_2 to be	combine from figure 1f	refer to figures
18 12	18 18	2, 4, 6 & 7	
18 12	12 12	2, 4, 5 & 8	
18 12	18 12	2, 4, 6 & 8	
18 12	12 18	2, 4, 5 & 7	
12 18	18 18	1, 3, 6 & 7	
12 18	12 12	1, 3, 5 & 8	
12 18	18 12	1, 3, 6 & 8	
12 18	12 18	1, 3, 5 & 7	
18 18	18 18	2, 3, 6 & 7	5 & 6
18 18	12 12	2, 3, 5 & 8	
18 18	18 12	2, 3, 6 & 8	
18 18	12 18	2, 3, 5 & 7	
12 12	18 18	1, 4, 6 & 7	
12 12	12 12	1, 4, 5 & 8	7 & 8
12 12	18 12	1, 4, 6 & 8	
12 12	12 18	1, 4, 5 & 7	
18 18	—	2 & 3	9 & 10
12 12	—	1 & 8	11 & 12
12 18	—	1 & 3	
18 12	—	2 & 4	

Table 3.

The 18 dB/octave low-pass filter, having the response given in figure 2a, with the nominal crossover frequencies obtainable using E12 series component values

f (Hz)	R (k Ω)	C _a (nF)	C _b (nF)	C _c (nF)
f1	R5	R6	R7	C3
f2	R16	R17	R18	C12
				C13
				C14
97	10	10	10	220
119	10	10	10	180
146	10	10	10	150
179	10	10	10	120
214	10	10	10	100
268	10	10	10	82
322	10	10	10	68
392	10	10	10	56
472	10	10	10	47
574	10	10	10	39
684	10	10	10	33
824	10	10	10	27
974	10	10	10	22
1191	10	10	10	18
1461	10	10	10	15
1766	10	10	10	12
2143	10	10	10	10
2679	10	10	10	8.2
3215	10	10	10	6.8
3921	8.2	8.2	8.2	6.8
4728	6.8	6.8	6.8	6.8
5742	5.6	5.6	5.6	6.8
6841	4.7	4.7	4.7	6.8
8244	3.9	3.9	3.9	6.8
9743	3.3	3.3	3.3	6.8

Table 2.

response (see figure 1f)	1	2	3	4	5	6	7	8	9	10
component										
R5			13	wl						wl
R6			13	t5						wl
R7			13	t5						t7
C3			13	—						—
C4			13	t5						—
C5			13	t5						t7
C8	wl	t4								wl
C9	t6	t4								wl
C10	t6	t4								t8
R10	—	t4								—
R11	t6	t4								—
R12	t6	t4								t8
R13	t6	t4								t8
R16							t3	wl		
R17							t3	t5		
R18							t3	t5		
C12							t3	—		
C13							t3	t5		
C14							t3	t5		
C17					wl	t4				
C18					t6	t4				
C19					t6	t4				
R21					—	t4				
R22					t6	t4				
R23					t6	t4				
R26					t6	t4				

see figure 3b 2b 2a 3a 3b 2b 2a 3a 4a 4b

Cross-reference table of frequency-determining components, starting from the 'available response curves' of figure 1f. The components are numbered as in the complete circuit and layout diagrams (figures 5 & 6); t3...t8 are the value-table references, 'wl' means 'wire link' and '—' means 'omit'.

Table 4.

The 18 dB/octave high-pass filter, having the response given in figure 2b, with the nominal crossover frequencies obtainable using E12 series component values.

f (Hz)	R _a (k Ω)	R _b (k Ω)	R _c (k Ω)	C (nF)
f1	R10	R11	R12 = R13	C8 = C9 = C10
f2	R21	R22	R23 = R26	C17 = C18 = C19
114	10	3.9	150	100
139	10	3.9	150	82
168	10	3.9	150	68
204	10	3.9	150	56
243	10	3.9	150	47
293	10	3.9	150	39
346	10	3.9	150	33
423	10	3.9	150	27
519	10	3.9	150	22
635	10	3.9	150	18
762	10	3.9	150	16
952	10	3.9	150	12
1140	10	3.9	150	10
1390	10	3.9	150	8.2
1680	10	3.9	150	6.8
2040	10	3.9	150	5.6
2430	10	3.9	150	4.7
2930	10	3.9	150	3.9
3460	10	3.9	150	3.3
4230	10	3.9	150	2.7
5190	10	3.9	150	2.2
6350	10	3.9	150	1.8
7620	10	3.9	150	1.5
9520	10	3.9	150	1.2
11400	10	3.9	150	1

How to use the tables.

- Decide on the type of filter required, and refer to figure 1f and/or table 1 for the 'shorthand notation'. Note that responses 9 and 10 are 6 dB/oct low-pass and high-pass, respectively; these are not shown in figure 1f.
- Proceed to table 2. Under each of the (two or four) chosen response curves, further information is given regarding a group of frequency-determining components. This can be either 'wl' (wire link), '-' (omit) or reference to one of the tables 3 . . . 8 (e.g. 't3' means 'refer to table 3').
- Proceed to the tables referred to. As an example, assume that slope 3 is required at a lower crossover frequency $f_1 = 400$ Hz. Under response 3, table 2 refers to table 3 for R_5 . . . R_7 and C_3 . . . C_5 . Proceeding to table 3, the nearest frequency to the desired 400 Hz is 392 Hz. For this frequency, the values of R_5 . . . R_7 are shown as 10 k Ω , $C_3 = 56$ n, $C_4 = 150$ n and $C_5 = 8$ n2.

Table 5.

The 12 dB/octave low-pass filter, having the response given in figure 3a, with the nominal crossover frequencies obtainable using E12 series component values.

f (Hz)	R (k Ω)	C ₃ (nF)	C ₄ (nF)	C ₅ (nF)
f1	R6 = R7	C4	C5	
f2	R17 = R18	C13	C14	
102	22	100	47	
125	18	100	47	
150	15	100	47	
188	12	100	47	
225	10	100	47	
274	10	82	39	
331	10	68	33	
402	10	56	27	
479	10	47	22	
577	39	10	4.7	
682	33	10	4.7	
834	27	10	4.7	
1020	22	10	4.7	
1250	18	10	4.7	
1500	15	10	4.7	
1880	12	10	4.7	
2250	10	10	4.7	
2740	10	8.2	3.9	
3310	10	6.8	3.3	
4020	10	5.6	2.7	
4790	10	4.7	2.2	
5840	8.2	4.7	2.2	
7040	6.8	4.7	2.2	
8550	5.6	4.7	2.2	
10190	4.7	4.7	2.2	

Table 7.

The 6 dB/octave low pass filter, having the response given in figure 4a, with the nominal crossover frequencies obtainable using E12 series component values.

f (Hz)	R (k Ω)	C ₅ (nF)
f1	R7	C5
106	10	150
133	10	120
159	10	100
194	10	82
234	10	68
284	10	56
339	10	47
408	10	39
482	10	33
589	10	27
723	10	22
884	10	18
1060	10	15
1330	10	12
1690	10	10
1940	10	8.2
2340	10	6.8
2840	10	5.6
3390	10	4.7
4080	10	3.9
4820	10	3.3
5890	10	2.7
7230	10	2.2
8840	10	1.8
10600	10	1.5

Table 6.

The 12 dB/octave high-pass filter, having the response given in figure 3b, with the nominal crossover frequencies obtainable using E12 series component values.

f (Hz)	C (nF)	R _D (k Ω)	R _C (k Ω)
f1	C9 = C10	R11	R12 = R13
f2	C18 = C19	R22	R23 = R26
113	100	10	39
137	82	10	39
165	68	10	39
201	56	10	39
239	47	10	39
289	39	10	39
341	33	10	39
417	27	10	39
511	22	10	39
625	18	10	39
750	15	10	39
938	12	10	39
1130	10	10	39
1370	8.2	10	39
1650	6.8	10	39
2010	5.6	10	39
2390	4.7	10	39
2890	3.9	10	39
3410	3.3	10	39
4170	2.7	10	39
5110	2.2	10	39
6250	1.8	10	39
7500	1.5	10	39
9380	1.2	10	39
11300	1	10	39

Table 8.

The 6 dB/octave high-pass filter, having the response given in figure 4b, with the nominal crossover frequencies obtainable using E12 series component values.

f (Hz)	R _C (k Ω)	C(nF)
f1	R12 = R13	C19
106	22	150
133	22	120
159	22	100
194	22	82
234	22	68
284	22	56
339	22	47
408	22	39
482	22	33
589	22	27
723	22	22
884	22	18
1060	22	15
1330	22	12
1590	22	10
1940	22	8.2
2340	22	6.8
2840	22	5.6
3390	22	4.7
4080	22	3.9
4820	22	3.3
5890	22	2.7
7230	22	2.2
8840	22	1.8
10600	22	1.5

Bibliography

- Electronics*, August 18th 1969, p82 etc (filter circuits)
 J.R. Ashley & L.M. Henne:
Operational Amplifier Implementation of Ideal Electronic Crossover Networks; JAES, January 1971.
 S. Linkwitz: *Active Crossover Networks for Noncoincident Drivers*; JAES, February 1976.
 J.R. Ashley & A.L. Kaminsky:
Active and Passive Filters as Loudspeaker Crossover Networks; JAES, June 1971.
 R.H. Small: *Constant-Voltage Crossover Network Design*; JAES, January 1971.
 B.B. Bauer: *Audibility of phase distortion*; *Wireless World*, March 1974.
 H.D. Harwood: *Audibility of phase effects in loudspeakers*; *Wireless World*, January 1976.

7

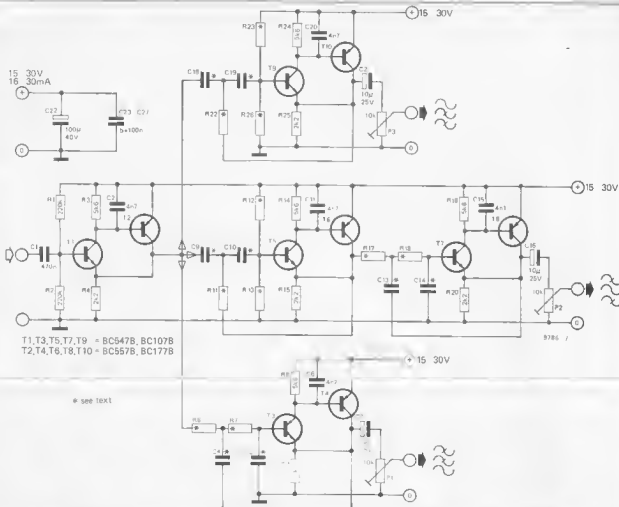

8

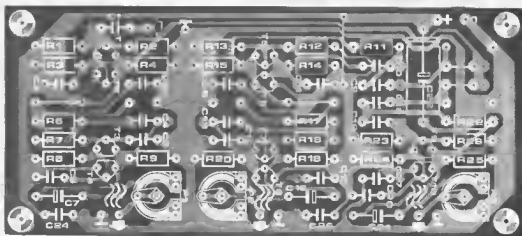

3-way, 12 dB/oct

As an example, assume that a three-way 12 dB/oct. filter system is required (slopes 1, 4, 5 and 8 in figure 1f) with crossover frequencies $f_1 = 400$ Hz and $f_2 = 3$ kHz.

Referring to table 2: for slope 1, C8 = wire link; R10 = omitted; C9, C10, R11 ... R13 are to be found from table 6 in the latter table, the nearest frequency to the desired f_1 is 417 Hz. The corresponding component values are given as C9 = C10 = 27 n; R11 = 10 k, R12 = R13 = 39 k. Back to table 2: for slope 4, R5 = wire link; C3 = omitted; R6, R7, C4 and C5

are to be found from table 5. Proceeding to this table, the component values corresponding to $f_1 = 402$ Hz are shown as R6 = R7 = 10 k; C4 = 56 n and C5 = 27 n.

Back to table 2: for slope 5, C17 = wire link; R21 = omitted; C18, C19, R22, R23 and R26 are to be found from table 6. For $f_2 = 2890$ Hz (the closest to the desired 3 kHz), this table gives the component values: C18 = C19 = 3n9; R22 = 10 k; R23 = R26 = 39 k.

Now table 2 again: for slope 8, R16 = wire link; C12 = omitted; R17, R18, C13 and C14 are to be found from table 5. For $f_2 = 2740$ Hz, this results in R17 = R18 = 10 k; C13 = 8n2;

Figure 7. Circuit diagram of an active three-way filter with symmetrical 12 dB/octave crossovers.

Figure 8. Parts layout modified for the figure 7 circuit.

C14 = 3n9.

Finally, referring to the parts list for figure 6 gives all other component values. Note that the footnotes 2 and 4 are valid in this case (12 dB/oct); however, we had already found these wire links and omitted parts from table 2.

9

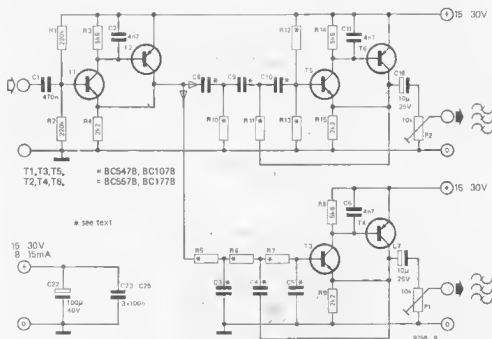

10

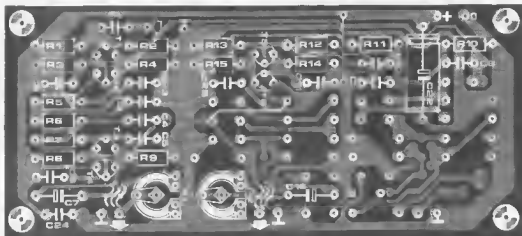

2-way, 18 dB/oct.

The two-way filter is assembled on the same board. In this case T6 collector has to be linked with the 'hot' side of C16—no matter which filter slopes are chosen—and the gain of the 'high' channel is preset by P2.

Correct use of the tables should produce this result automatically. As an example, assume that slopes 2 and 3 are required at a crossover frequency $f_1 = 500$ Hz. For slope 2, table 2 refers to table 4 for the following components: C8... C10 and R10... R13. For slope 3, the table refers to table 3 for R5... R7 and C3... C5.

Proceeding first to table 4, the component values for $f_1 = 519$ Hz are found to be: R10 = 10 k, R11 = 3k9, R12 = R13 = 150k, C8 = C9 = C10 = 22n. Referring now to table 3, the component values for $f_1 = 472$ Hz are found to be: R5 = R6 = R7 = 10 k; C3 = 47 n; C4 = 120 n; C5 = 6n8.

Finally, the parts list for figure 6 gives all other components. Footnote 1 is valid in this case: 'omit this part for two-way filter set'. This turns out to mean that T9 and T10 (figure 5) are omitted, with all associated components; T7 and T8 are also omitted, with all associated components. Furthermore, footnote 6 is valid: 'replace by wire link

Figure 9. Two-way circuit with symmetrical 18 dB/octave crossover.

Figure 10. Parts layout modified for the figure 9 circuit.

for two-way filter set'. This refers to R16, R17 and C13, giving the required through path from T6 to C16. Note however that on the component layout a single wire link is shown, direct from one end of R16 to one end of C13. This will also work of course...

11

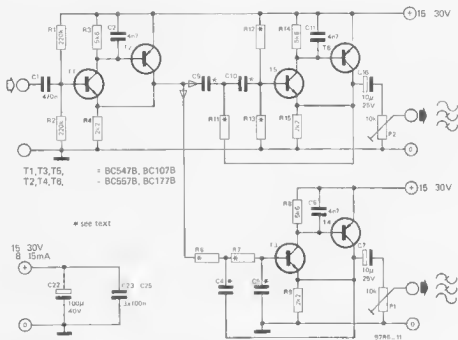

12

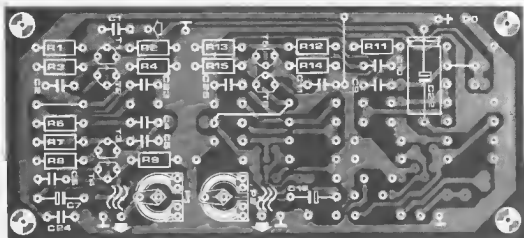

2-way, 12 dB/oct.

In figure 11, the required slopes are numbered 1 and 4. Assume that the crossover frequency is to be $f_1 = 1$ kHz. As before, the first table to look at is table 2. For slopes 1 and 4, C8 and R5 both have to be replaced by wire links; R10 and C3 are omitted; the values for C9, C10 and R11, . . . R13 are to be found from table 6; the values for R6, R7, C4 and C5 are to be found from table 5.

First table 6. For $f_1 = 938$ Hz, the component values are given as follows: C9 = C10 = 12 n; R11 = 10 k, R12 = R13 = 39 k.

Now table 5. Here the nearest frequency given is $f_1 = 1020$ Hz. The corresponding

component values are: R6 = R7 = 22 k; C4 = 10 n; C5 = 4n7.

Finally, check the parts list. In this case, footnotes 1, 2, 4 and 6 are all valid. In other words, components marked either ¹ or ⁴ are to be omitted and components marked either ² or ⁶ are to be replaced by wire links.

To sum it up, the complete parts list for this example would be.

Resistors:

R1, R2 = 220 k
R3, R8, R14 = 5k6
R4, R9, R15 = 2k2
R5 = wire link
R6, R7 = 22 k
R11 = 10 k

R12, R13 = 39 k
R16, R17 = wire link
P1, P2 = 10 k preset

Capacitors:

C1 = 470 n
C2, C6, C11 = 4n7
C4 = 10 n
C5 = 4n7
C7, C16 = 10 μ /25 V
C8 = wire link
C9, C10 = 12 n
C13 = wire link
C22 = 100 μ /40 V
C23, C24, C25 = 100 n

Semiconductors:

T1, T3, T5 = BC107 B or equivalent
T2, T4, T6 = BC177 B or equivalent

13

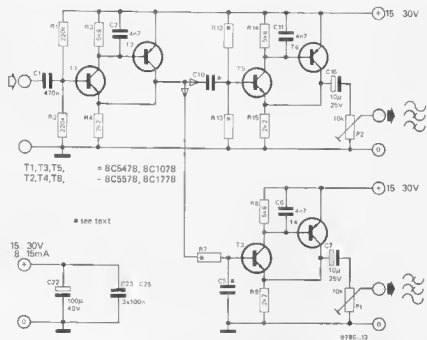

14

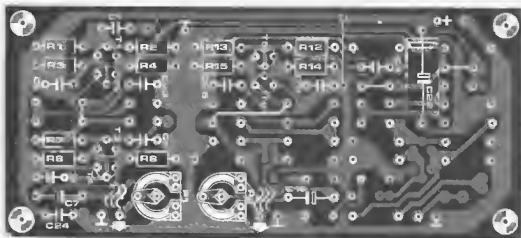

Figure 11. Two-way circuit with symmetrical 12 dB/octave crossover.

Figure 12. Parts layout modified for the figure 11 circuit.

Figure 13. 6 dB/octave two-way circuit diagram.

Figure 14. Parts layout modified for the figure 13 circuit.

2-way, 6 dB/oct.

Before going any further, it should be stated clearly that 6 dB/oct slopes are only useful in a very limited number of applications. They should be used with caution, since there is always a danger of destroying the high-range loudspeaker.

However, for completeness' sake an example is given here: two-way, 6 dB/oct (slopes 9 and 10, not shown in figure 1f), with a crossover frequency $f_1 = 4$ kHz.

Table 2 specifies a wire link for R5, R6, C8 and C9; C3, C4, R10 and R11 are to be omitted. The values for R7 and C5 are to be taken from table 7; the values for C10, R12 and R13 are to be taken

from table 8.

For $f_1 = 4080$ Hz, table 7 specifies R7 = 10 k and C5 = 3n9.

For $f_1 = 4080$ Hz, table 8 specifies R12 = R13 = 22 k and C19 = 3n9.

In this case, all 6 footnotes in the parts list are valid . . . Since footnotes 1, 4 and 5 are valid, the following components should be omitted: R10, R11, R18 . . . R26; P3; C3, C4, C12, C14, C15, C17 . . . C21, C26, C27; T7 . . . T10. Furthermore, since footnotes 2, 3 and 6 are valid, the following components are to be replaced by wire links: R5, R6, R16, R17; C8, C9, C13. Note that C17 has already been eliminated by footnote 1, and is therefore not replaced by a wire link when we get to footnote 2!



New instrument cases

Encouraged by the success of their Contil Mod-2 and Mod-3 range of instrument cases, West Hyde has launched a new complementary range of cases called Mod-4.

This new case is inexpensive. It can be assembled quickly, requiring only eight screws; the top four screws allow the lid to be removed and the other four hold all the other six parts together. The bottom panel screws hold the aluminium chassis, supplied free with the case.



The Mod-4 comes in a scuff-resistant P.V.C. coated steel with an intense shiny black leather-textured finish and a contrasting bright white steel panel, being completely flat. Mod-4 comes in six sizes ranging from 178 x 152 x 76 mm to 279 x 152 x 152 mm. Prices start from £ 3.33 for one off including postage and packing, with big discounts for quantities.

West Hyde Developments Ltd.,
Ryefield Crescent, Northwood,
Middlesex HA6 1NN

(459 M)

Modemulators offer alternative to modems

The new 1622 and 1623 synchronous modemulators from Nolton Communications Ltd. have been designed to replace

high-speed narrowband synchronous modems for intra-city data communications over privately owned 4-wire circuits. A pair of the Nolton units, costing less than £ 1000 in total, could be used instead of a pair of conventional modems costing up to £ 12 000 for communication over distances of up to 16 km. Differential current drivers are incorporated to minimise error-rate problems and to ensure high noise immunity when used with a balanced two-wire twisted pair system.

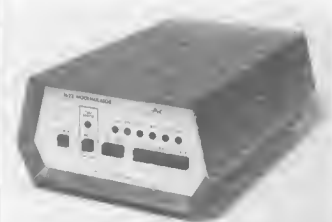

The units are compatible with standard V24 or V35 (1622 only) data-terminal equipment interfaces, and allow selection of half or full duplex mode of operation. Speeds may be selected from 2400 baud to 4800 baud, and the equipment, which can operate without a DC connection, utilises a novel data encoding technique. The modemulators can be used with high-speed mainframes, for remote plant working, remote siting of terminals etc. Several remote stations can be connected to a single base station by use of the multipoint facilities built into the unit. Built-in diagnostic facilities include a pseudorandom pattern generator.

The modemulators are self-contained, powered from a normal 13 A outlet and require no external power from the data-terminal equipment.

Nolton Communications Limited,
Fieldings Road, Cheshunt,
Waltham Cross, Herts

(481 M)

Function generator

Dana Electronics have announced a new portable low-cost function generator, made by their associate company Exact Electronics Inc. Model 119M has a dynamic frequency range from 0.02 Hz to 2.2 MHz, with sine, square, triangle and variable time symmetry of all waveforms for ramp and pulse operation. A v.c.f. input is provided to allow the generator frequency to be varied either up or down, or

frequency-modulated over a range of 100:1 (three decades). Minus 10 V d.c. will increase the frequency by three decades from a minimum multiplier setting, and plus 10 V d.c. will decrease the frequency three decades from a maximum setting.

The 50 ohms HI output delivers 20 V p-p open circuit, or 10 V p-p into a 50 ohm load. The LO 50 ohms output delivers a simultaneous output, identical to the HI output but 30 dB down. Output voltage is controlled continuously over 30 dB by

means of the amplitude control. Also on the front panel is an 'invert' switch, to reverse the polarity of the pulse and ramp waveforms. An output voltage d.c. offset of ± 10 V is provided.

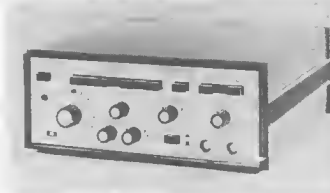

A TTL-compatible pulse output capable of sinking 20 TTL loads is available at the rear panel. Also on this panel is an a.m. input for modulation of the generator, applied to either sine, square or triangle carriers. Separate carrier and modulation controls are provided on the Model 119M, so that the user can vary the percentage modulation. The small size of this instrument, with its high-impact-resistant case, economy and versatility will make it attractive to service and school labs, service shops, and test/production lines. Price £ 230.00; delivery 6 weeks.

Dana Electronics Ltd.,
Collingdon Street, Luton,
Beds. Tel. 0582 24236.

(479 M)

Amplifier for medical applications

The new Gould 13-4615-50 transducer preamplifier is designed for use with strain-gauge transducers, resistance temperature devices or other low-level d.c.



inputs in medical and biophysical applications. It can be used with Gould 2000 Series direct-writing recorders or in a portable case with other readout instruments, and offers very stable bridge excitation, high rejection of electrical noise, and calibrated zero suppression.

The unit is a single channel, direct-coupled, plug-in d.c. bridge amplifier capable of handling signals from 100 μ V to 5 V full scale. Direct (pulsed) or average (mean) values can be selected from a front-panel switch. Common-mode rejection

is high, allowing operation in electrically noisy environments. The calibration zero suppression gives a resolution of within 0.1%, while a regulated bridge excitation provides $\pm 0.05\%$ long-term stability. A calibrated sensitivity control provides known amplifier gain settings for each of the six fixed gain ranges, ensuring precise direct calibration for all types of signal input. A low-pass 2-pole output filter is internally selectable to minimise objectionable high-frequency signal components. Simultaneous outputs are provided for digital displays and auxiliary monitors.

Gould Advance Limited,
Raynham Road, Bishop's
Stortford, Herts.

(476 M)



3-in-1 wire wrapping tool

Verosped, the new Distribution Division of VERO Electronics Ltd., have recently introduced what they believe to be the most attractively priced hand wire wrapping tool on the market to-day. It is a precision engineered wire wrapping, unwrapping and stripping tool (see photographs 1, 2 and 3) designed to make a "regular wrap" joint with 30 AWG

wire on 0.6 mm (.025") square posts. The size of the tool, 112 x 8 mm, makes it ideal for R. & D. Departments, service workshops, field service engineers, industrial and educational laboratories or any location where wire wrapping capability for repair maintenance or modification is required.

The price of this tool, including postage and packing, is £7.72 and is available ex-stock by return from VERO-Verosped.

*VerO Electronics Limited,
Industrial Estate,
Chandler's Ford, Eastleigh,
Hants SO5 3ZR*

(429 M)

Scope probes for IC circuit boards

The first 'scope probes designed to connect readily to individual pins on modern DIP's - or to the small, insulated conductors characteristically used on modern IC circuit boards - without hazard of shorting are claimed by Hewlett-Packard.

HP's solution to the problem consists of a clip that encompasses an entire DIP, and an accompanying set of demountable probes, believed the smallest yet commercially offered. The basic part of each probe can be inserted by itself into the DIP clip at any pin position; indeed, 15 of them can be inserted simultaneously into a DIP clip; one position is used with a grounding pin, so any

pin of the DIP can be used as probe ground, holding lead inductance to a minimum. The basic part of each probe has a needle-like tip. The tip is sharp enough to make contact through the insulation coating of conductors commonly used on modern IC circuit boards.

When an insulating sleeve is slipped over the grounded shaft of the tip body, the tip can make momentary contact at any pin of a bare DIP without the likelihood of shorting to adjacent pins.

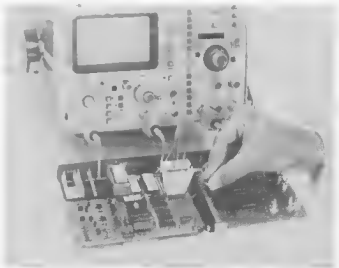

Where grounding close to the tip is desired, the insulating sleeve can be retracted far enough to permit a ground pin to be slipped over the tip body. An adapter barrel slips over the insulating sleeve to convert the probe into a pincher-tip probe, conventional in configuration but about one-third the size of conventional pincher probes. Even without the DIP clip, then, these probes can be connected to individual pins with confidence they will not short elsewhere.

The variety of probes in the new HP series includes 10 : 1 dividers with precision film resistors enclosed within the 3.3-mm (0.13") diameter body of the basic probe.

The series includes high-impedance dividing probes suitably compensated for most oscilloscopes with input capacitances of 9 to 14 pF (10017A and 10018A) for HP Models 1710B through 1722A and 20 to 30 pF (10040A, 10041A, 10042A) for HP Models 1740A and 1741A and Tektronix Type 464, 465, 466.

1 : 1 probes are also available. Each is offered with a choice of 1-metre or 2-metre length cable (a 3-metre length is available for the 20 to 30 pF input C range). The HP miniature divider probes are £70 each. 1 : 1 probes are £27. The companion 10024A IC Test Clip is £12.

*Hewlett-Packard Limited
King Street Lane, Winnersh,
Wokingham, Berkshire,
RG11 5AR*

(460 M)

20 A relay

Arrow-Hart have announced the new 30 series relay, designed to meet the U.K. and European standards for domestic appliance and business machinery applications, at low cost.

The 30 series is a 20 A rated relay of 2 pole changeover type, available with wide-range, low VA/ watts AC and DC coils, suitable for operation in temperatures as high as 85°C ambient. For quantity orders, Arrow-Hart will also supply it in 2 pole N/O form,

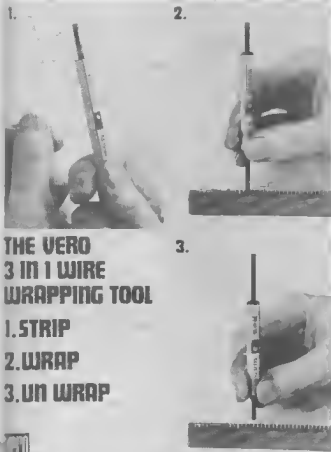

THE VERO 3 IN 1 WIRE WRAPPING TOOL

1. STRIP
2. WRAP
3. UN WRAP



with a 3 mm contact gap across each pole when open, to conform with safety isolation requirements.

The new relay is a compact design, protected under a clear moulded dust cover. Spade terminals provide for fast wiring,

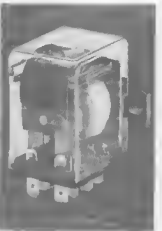

and Arrow-Hart describe the pricing as 'very competitive' for the applications area. Performance data for the 30 series is now incorporated in a new relays catalogue along with the established 28 and MPR series, available from Arrow-Hart.

*Arrow-Hart (Europe Ltd.)
Plymbridge Road
Estover
Plymouth PL6 7PN*

(483 M)



Fibre optic kits

For assisting design engineers and students alike, Centronic are now able to offer two types of Fibre Optic kit. They come complete with an application handbook illustrating the basic circuitry required to replace any existing metallic transmission system with a Centronic fibre optic system.

The kits contain 2 transmitters, 2 receivers and 1 or 2 lengths of fibre cable. 2 types of cable termination are offered, either the screw ferrule or the BNC

plug-in type. For easy handling and storage, the kits are supplied in a tough attache style case.

Twentieth Century Electronics Ltd., King Henry's Drive, New Addington, Croydon, CR9 0BG.

(478 M)

Ganged SpectraDIL modules

Erg Components have increased their new U.K. made range of SpectraDIL switches to include five ganged styles. Incorporating

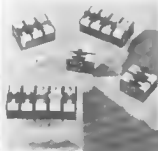

the laterally operated colour coded sliders. This style has a black body to distinguish it from the standard range.

Available in 2, 4, 6, 8 and 10 ganged pole versions, 8.2 mm (including stand offs) high x 10.6 mm wide and from 5 mm to 25 mm long. The design which has a patent pending includes a self draining body and helical coil sprung gold plated wiping contacts for positive on/off action.

Life is claimed in excess of 100,000 operations within rated load of 1 μ V to 100 V AC, 1 μ A to 1 A at up to 10 VA. Prices from only 10 p per pole per switch at the 100 rate.

Erg Industrial Corp. Ltd., Luton Road, Dunstable, Beds, LU5 4LJ

(458 M)

30 dB gain/1.6 dB noise at 60 MHz

A low noise amplifier (1.6 dB noise figure) in a low profile flatpack configuration provides up to 30 dB gain at 60 MHz. The Anzac Model AM-113, available from stock, is specified for operation from 10 to 100 MHz. Output power (1 dB compression) is typically +17 dBm. Bias power required is only 1 watt (+15 VDC, 70 ma, maximum).

Third Order Intercept of the high reliability AM-113 is +33 dBm (typical).

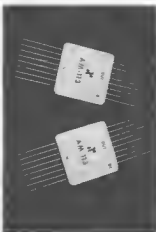

Performance specifications are guaranteed over the operating temperature range from -55°C to $+85^{\circ}\text{C}$.

The Model AM-113 amplifier is priced at \$ 350 (1 to 5 quantity).

Anzac Electronics, 39 Green Street, Waltham, Massachusetts 02154, U.S.A.

(480 M)

High-capacitance ceramic disc capacitors

Compstock announces the availability of Erie new range of 'Transcap' high-capacitance ceramic disc capacitors with values from 0.01 to 0.22 microfarads. These high-capacitance, low voltage components are designed for applications where small volume and low cost are paramount and where an increasing dissipation factor at higher frequencies is unimportant. Using semiconductor barrier layer



techniques, the Transcaps are manufactured in four styles, with working voltage ratings of 10, 12, 25 and 40 volts DC. The capacitance tolerance is ± 25 to ± 50 percent and the maximum continuous alternating voltage is 10 percent of the DC working voltage.

Finished with a phenolic insulating coating, these capacitors may be used over the operating temperature range of -55 to $+85^{\circ}\text{C}$ and the terminations are a solder alloy coated copper wire.

Compstock Electronics Ltd., 42/44 Bowlers Croft, Basildon, Essex

(482 M)

Single conductor receptacles with safety interlock switch

Lee Green Precision Industries Limited offer CAM-LOK patented Single Conductor Female Receptacles for polyphase high current applications. These have a spring loaded plunger within the receptacle which is depressed by the mating contact.

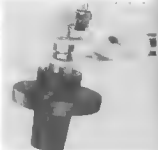

As the plunger is moved, it activates a limit switch mounted on the rear of the receptacle. The limit switch contacts are wired in series in the control circuit so that the power circuit can only be energized when all phase connectors are engaged. If any one of the phase connectors is disconnected, its limit switch will cut out the main circuit power, thus eliminating shock hazard. CAM-LOK connectors and Receptacles have totally shielded electrical contacts.

Lee Green Precision Industries Ltd., Grottes Place, Blackheath, London SE3 0RA.

(475 M)



babani press

NEW ADDITIONS AVAILABLE TO ELEKTOR READERS

ELECTRONIC CALCULATOR USERS HANDBOOK

The 'Electronic Calculator Users Handbook' presents Formulas, Data, Methods of Calculation, Conversion Factors etc., with the calculator user especially in mind and up to now to the best knowledge of the author these has never been a book available that does this so comprehensively for such an inexpensive price. 95p



HANDBOOK OF IC AUDIO PREAMPLIFIER & POWER AMPLIFIER CONSTRUCTION

Shows what audio IC's are, as well as how to use them
Includes practical constructional details of various IC and Hybrid IC/Transistor designs of about 250 mW to 100 W output
This book is written by the very experienced and popular author Mr. F. G. Ray, who deals with the subject in four parts:
Part I: Understanding Audio IC's
Part II: Preamplifiers, Mixers and Tone Controls
Part III: Power Amplifiers and Speakers
Part IV: Hybrid Circuits
An ideal book for both beginner and advanced enthusiasts alike. 95p



SOLID STATE SHORT WAVE RECEIVERS FOR BEGINNERS

In this book the author has designed and developed several modern solid state short wave receiver circuits that will give a fairly high level of performance. Ensure the fact that they use only relatively low inexpensive components. 95p

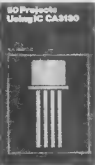

50 PROJECTS USING IC - CA3190

Contents cover a wide range of projects under 6 basic headings: About the IC, Audio Projects, RF Projects, Test Equipment, Household Projects and Miscellaneous. 95p



28 TESTED TRANSISTOR PROJECTS

Most of the circuits are very economic on the use of components and in many cases the semiconductors employed are non-critical, commonly available and inexpensive types.
Some of the circuits are completely new and, to the best knowledge of the author, unlike anything previously published while others may bear similarity to more familiar designs. 95p

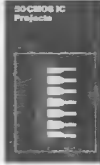

50 CMOS IC PROJECTS

Covers an introduction to CMOS IC's followed by Multivibrator Projects with Astable, Bistable and Monostable circuits, plus Amplifiers and Oscillators, Schmitt Trigger Circuits, and Special devices. 95p

POST & PACK FREE IF 3 OR MORE TITLES ORDERED AT THE SAME TIME

- FIRST BOOK OF TRANSISTOR EQUIVALENTS & SUBSTITUTES**
A handbook containing 73 pages of transistor equivalents and substitutes including British, German, Dutch, USA, Japanese and European manufacturers. 40p
- SECOND BOOK OF TRANSISTOR EQUIVALENTS & SUBSTITUTES**
Complementary to the first book with over 56,000 additional equivalents and substitutes covering virtually all known types at time of publishing. 95p
- HANDBOOK OF INTEGRATED CIRCUITS (IC's) EQUIVALENTS & SUBSTITUTES**
115 pages of most available types of integrated circuits which have equivalents in sub-circuits. 75p
- PRACTICAL ELECTRONIC SCIENCE PROJECTS**
12 construction projects including Electrostatic Gage, radiation counter, Digital clock etc with circuit diagram & parts lists. 75p
- PRACTICAL STEREO AND QUADROPHONY HANDBOOK**
Stereo recording, 10 plus 10 stereo amplifier, Quadasonic reproduction etc. are detailed in its 90 pages. 75p

If you do not wish to spoil your copy of Elekto please make a note of the books you require with your name and address and send it to us with your remittance.

- PRACTICAL ELECTRONIC PROJECTS**
A selection of construction projects with circuit diagrams and parts lists including a simple to build, portable receiver, 21 watt amplifier for guitars and a simple tester for Digital IC's. 75p
- 79 ELECTRONIC NOVELTY CIRCUITS**
Circuits include Burger alarm, Reaction timer, game, Wide range frequency doubler, Simple capacitance and Transistor tester, Intercom and signaling devices etc. etc.
Interchangeables and equivalents of solid state devices used are also given. 78p
- WORLD'S SHORT MEDIUM & LONG WAVE FM & TV BROADCASTING STATIONS LISTING**
91 pages of listing giving station, country, K/C/S and KW ratings. 60p
- THE COMPLETE CAR RADIO MANUAL**
Includes the selection of a radio and its installation, aerials, suppression and fault finding. 90 pages. 75p
- MODERN TAPE RECORDING HANDBOOK**
Covers microphones, sound effects, tones and editing, fault finding etc. illustrated in its 91 pages. 75p
- DIODE CHARACTERISTICS EQUIVALENTS & SUBSTITUTES**
European, USA, Asian, Japanese, USSR and Military service types etc. including varicaps and Zener diodes. 25,000 entries with index in 9 languages. Over 150 pages. 55p
- RADIO TV AND ELECTRONICS DATA BOOK**
Over 900 pages of facts and figures including wavelengths and frequency tables, International morse code, the O code, Resistance, wire data and many others. 60p
- RADIO TV INDUSTRIAL & TRANSMITTING TUBE & VALVE EQUIVALENTS**
Handbook of equivalents, British, European and USA designations of valves, CRT's and tubes, New system projection CRT's (tube) etc. etc. 60p

Please send me (tick box)

I enclose remittance of _____ for the books and 20p post and packing

Name _____

Address _____

Postcode _____

**ORDER NOW FROM:
Elektor Publishers Ltd,
6 Stour Street,
Canterbury,
Kent CT1 2XZ**