

up-to-date electronics for lab and leisure

Simon & Schuster ELECTOR 17

- m.p.g indicator
- ignition timing strobe
- car service meter
- windscreen wiper delay
- rev counter



elektor decoder

What is a TUN?
What is 10 n?
What is the EPS service?
What is the TQ service?
What is a missing link?

Semiconductor types

Very often, a large number of equivalent semiconductor types exist with different type numbers. For this reason, 'abbreviated' type numbers are used in Elektor wherever possible:

- '741' stands for μ A741, LM741, MC741, M1C741, RM741, SN72741, etc.
- 'TUP' or 'TUN' (Transistor, Universal, PNP or NPN respectively) stands for any low frequency silicon transistor that meets the specifications listed in Table 1. Some examples are listed below.
- 'DUS' or 'DUG' (Diode, Universal, Silicon or Germanium respectively) stands for any diode that meets the specifications listed in Table 2.
- 'BC107B', 'BC237B', 'BC547B' all refer to the same 'family' of almost identical better-quality silicon transistors. In general, any other member of the same family can be used instead. (See below.)

For further information, see 'TUP, TUN, DUG, DUS', Elektor 17, p. 946.

Table 1. Minimum specifications for TUP (PNP) and TUN (NPN).

V _{CE} , max	20V
I _C , max	100 mA
h _{FE} , min	100
P _{tot} , max	100 mW
T _{min}	100 MHz

Some 'TUN's are: BC107, BC108 and BC109 families; 2N3856A, 2N3859, 2N3860, 2N3904, 2N3947, 2N4124. Some 'TUP's are: BC177 and BC178 families; BC179 family with the possible exception of BC159 and BC179; 2N2412, 2N3251, 2N3906, 2N4126, 2N4291.

Table 2. Minimum specifications for DUS (silicon) and DUG (germanium).

	DUS	DUG
V _R , max	25V	20V
I _F , max	100mA	35mA
I _R , max	1 μ A	100 μ A
P _{tot} , max	250mW	250mW
C _D , max	5pF	10pF

Some 'DUS's are: BA127, BA217, BA218, BA221, BA222, BA317, BA318, BAX13, BAY61, 1N914, 1N4148.

Some 'DUG's are: OA85, OA91, OA95, AA116.

BC107 (-8, -9) families:
BC107 (-8, -9), BC147 (-8, -9), BC207 (-8, -9), BC237 (-8, -9), BC317 (-8, -9), BC347 (-8, -9), BC547 (-8, -9), BC171 (-2, -3), BC182 (-3, -4), BC382 (-3, -4), BC437 (-8, -9), BC414

BC177 (-8, -9) families.

BC177 (-8, -9), BC157 (-8, -9), BC204 (-5, -6), BC307 (-8, -9), BC320 (-1, -2), BC350 (-1, -2), BC557 (-8, -9), BC251 (-2, -3), BC212 (-3, -4), BC512 (-3, -4), BC261 (-2, -3), BC416.

Resistor and capacitor values

When giving component values, decimal points and large numbers of zeros are avoided wherever possible. The decimal point is usually replaced by one of the following international abbreviations:

p (pico) = 10^{-12}
n (nano) = 10^{-9}
 μ (micro) = 10^{-6}
m (milli-) = 10^{-3}
k (kilo-) = 10^3
M (mega-) = 10^6
G (giga-) = 10^9

A few examples:
Resistance value 2k Ω : this is 2.7 k Ω , or 2700 Ω .
Resistance value 470: this is 470 Ω .

Capacitance value 4p7: this is 4.7 pF, or 0.0000000047 F...
Capacitance value 10 n: this is the international way of writing 10,000 pF or 0.01μ F, since 1 n is 10^{-9} farads or 1000 pF.

Mains voltages

No mains (power line) voltages are listed in Elektor circuits. It is assumed that our readers know what voltage is standard in their part of the world! Readers in countries that use 60 Hz should note that Elektor circuits are designed for 50 Hz operation. This will not normally be a problem, however, in cases where the mains frequency is used for synchronisation some modification may be required.

Technical services to readers

- **EPS service.** Many Elektor articles include a buy-out for a printed circuit board. Some - but not all - of these boards are available ready-etched and prefilled. The 'EPS print service list' in the current issue always gives a complete list of available boards.

- **Technical queries.** Members of the technical staff are available to answer technical queries (relating to articles published in Elektor) by telephone on Mondays from 14.00 to 16.30. Letters with technical queries should be addressed to: Dept. TQ. Please enclose a stamped, self-addressed envelope; readers outside U.K. please enclose an IRC instead of stamps.

- **Missing link.** Any important modifications or additions to, or improvements on, or corrections in Elektor circuits are generally listed under the heading 'Missing Link' at the earliest opportunity.

ELEKTOR

17 Volume 2
Number 9

Editor : W. van der Horst
Deputy editor : P. Holmes
Technical editors : J. Barendrecht
G.H.K. Dam
E. Krempelsauer
G.H. Nachbar
Fr. Scheel
*K.S.M. Walraven
Art editor : C. Sinke
Drawing office : L. Martin
Subscriptions : Mrs. A. van Meyel

UK editorial offices, administration and advertising:

6 Stour Street, Canterbury CT 1 2XZ.
Tel. Canterbury (0227) - 54430.
Telex: 955504.

Bank: Midland Bank Ltd Canterbury A/C No. 11014587,
Sorting code 40-16-11, giro: no. 315 4254.

Assistant Manager and Advertising : R.G. Knapp
Editorial : T. Emmers

Elektor is published monthly on the third Friday of each month, price 40 pence.

Please note that number 15/16 (July/August) is a double issue. 'Summer Circuits', price 80 pence. Single copies (including back issues) are available by post from our Canterbury office to UK addresses and to all countries by surface mail at £ 0.55. Single copies by air mail to all countries are £ 0.90. Subscriptions for 1976 (January to December inclusive) to UK addresses and to all countries by surface mail: £ 6.25, to all countries by air mail £ 11.-. Subscriptions for 1976 (October to December inclusive), to UK addresses and to all countries by surface mail: £ 1.60. All prices include p & p.

Subscribers are requested to notify a change of address four weeks in advance and to return envelope bearing previous address.

Letters should be addressed to the department concerned: TO = Technical Queries; AOV = Advertisements; SUB = Subscriptions; ADM = Administration; ED = Editorial (articles submitted for publication etc.); EPS = Elektor printed circuit board service. For technical queries, please enclose a stamped, addressed envelope.

The circuits published are for domestic use only. The submission of designs or articles to Elektor implies permission to the publishers to alter and translate the text and design, and to use the contents in other Elektor publications and activities. The publishers cannot guarantee to return any material submitted to them. All drawings, photographs, printed circuit boards and articles published in Elektor are copyright and may not be reproduced or imitated in whole or part without prior written permission of the publishers.

Patent protection may exist in respect of circuits, devices, components etc. described in this magazine. The publishers do not accept responsibility for failing to identify such patent or other protection.

Distribution: Spotlight Magazine Distributors Ltd., Spotlight House 1, Bentwell road, Holloway, London N7 7AX.

Copyright © 1976 Elektor publishers Ltd - Canterbury

Printed in the Netherlands.

contents

selektor	907
quedrille	910
The ideas behind the (quadrophonic) systems.	
Music of the spheres	910
Several tools have been proposed for evaluating and comparing quadrophonic matrix systems. For those of us who are not gifted mathematicians, but who like to 'see' what is happening, the "energy spheres" approach suggested by P. Scheiber can be quite useful.	
Tachometer	916
This Tachometer adaptor was primarily designed to be used in conjunction with the UAA 170 LED meter (Elektor 12, April 1976, p. 441) and will give a clear 'analogue' indication of the number of revolutions made by the car engine.	
Rev counter and dwell meter - C. Wünsche	921
A rev counter and dwell meter is a useful service aid when setting up the ignition timing of a car. The instrument described here will indicate dwell angle as a percentage of the complete timing cycle and will measure engine r.p.m. in two ranges that are selected automatically depending on engine speed.	
Windscreen wiper delay circuits and how to install them - A.J. Cartwright	924
Servotape - R. Hardcastle	928
Miles-per-gallon indicator	929
A fuel consumption meter indicating 'miles per gallon' is a useful instrument for economy-minded motorists. By making one minor modification to an existing petrol flow meter made by ABM, the long wished for MPG indicator can become a reality.	
From stereo to SQ - 8. Bauer	934
In Elektor 8 (December 1975) we published a background article on CD 4 and a construction project for a CD-4 demodulator, both sent to us by JVC. At the time, we stated in an editorial note that we wished to give the proponents of the other three systems an equal opportunity. CBS has responded by sending us two articles on SQ. As with the previous articles, we have decided to publish them in full.	
SQL-200 SQ decoder - D.W. Gravereaux	938
The SQL-200 is a 'free-standing' SQ decoder with its own power supply, intended for converting stereo receiver/preamplifiers to SQ quadrophony. The unit is of full logic with variable-bias type.	
Ignition timing stroboscope	944
There are several ways of adjusting the ignition of a car engine. One of the quickest and best is to use a stroboscope.	
Transistors, TUP/TUN/DUG/DUS, ICs	947
Markt	952
Missing link	957
Advertisers index	957



Nuclear battery

This miniature nuclear battery – only 35 mm long and 15 mm in diameter – has been developed in Britain by the United Kingdom Atomic Energy Authority. It uses heat from the radioactive decay of a small quantity of plutonium-238 to generate electricity in a miniature semi-conductor thermopile (an apparatus formed of rods of special metals connected in parallel). The design of the battery, including the encapsulation of the plutonium, ensures that there is no hazard either from radiation or from the escape of radioactive material. It has a design life of 20 years and has been applied in the first instance to implanted heart pacemakers that bring a new lease of life to thousands of people suffering from certain types of heart troubles. The technology for the battery has been developed over a six year period during which time it has been subjected to

stringent, internationally agreed safety standards to ensure that it will withstand the most severe accident, fire, impact – or even cremation. *British information services*
Central office of information
Charles II street
London SW1Y 4QP

A telephone to television domestic information system

Progress in digital integrated circuit technology can provide information storage and processing relatively cheaply. In addition, the use of existing transmission media may provide important new information services. An example is the experimental Teletext system being transmitted as 'Ceefax' and 'Oracle'.

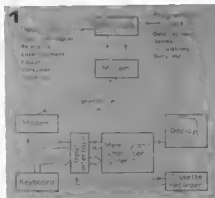

Each TV channel may transmit data for a magazine of 100 pages for selection by the viewer, who may have to wait for up to 24 seconds for the page he requires. The selected page is stored in a digital memory contained in or associated with the TV and is subsequently displayed as up to 960 characters in 6 possible colours plus white and a limited graphics facility. Because it is a one-way system, any increase in the number of pages available means an increase in waiting time.

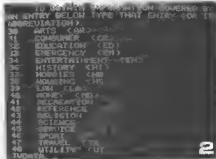

Alternatively, sending the data by wire but using the same digital memory, provides an almost unlimited number of pages and has a short access time. The two-way facility means that only the required information is sent to the viewer. Also, interaction becomes possible for games, quizzes and instructional uses.

At Mullard Research Laboratories (MRL) a system has been set up which enables TV receivers to display information sent over telephones lines from a central computer. This may be either the Post Office experimental Viewdata computer or Mullard's own computer which allows experiments on interactive use to be made. Figure 1 shows a schematic diagram of a generalised home terminal connected via the telephone line to the computer. It comprises a modem, data store, character generator, a TV display, keyboard and peripherals such as a cassette recorder for data storage. At the computer information is stored on disc with magnetic tape back-up.



In general, a two-way telephone system can provide facilities which may be grouped under three headings:

1. *One-way information*: local and general information, private information, etc.
2. *Two-way communication*: person to person, diary, etc.
3. *Interactive/data processing*: games, education, calculations, financial transactions, etc.

The MRL data base provides facilities under all three headings as shown by the index in figure 2. The information content contains much from local and regional sources since recent market surveys indicated these to be important. Apart from information, the 'Diary' and 'Small Ads' facilities both allow the user to input his own information. There are



also various games for demonstrating the interactive possibilities (see photo). User access is via a tree structure from the main index (figure 2) through sub-indexes to the page or pages required. The main programme contains a directory of all the sub-indexes listed in the main index. Each sub-index also contains a similar directory of further sub-indexes all of which are transferred from disc-file to core memory as required.

The user types in either a number or a word for the heading required at each level until the page is reached. Alternatively a page may be reached directly. For example, one system tried uses simple abbreviations so that 'LO HI RE' would give information on the Local History of the nearby town of Redhill. The 'Diary' facility enables individual users to enter dates and appointments which may then be accessed when required. An 'auto-reminder' facility is also included. Under 'Small Ads' users may enter their own advertisements under appropriate classification. Other users may use the same facility to retrieve the information.

An experimental home terminal

A simple terminal for information retrieval in the home is illustrated in

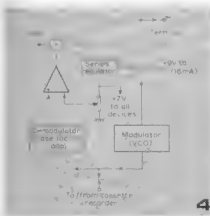

figure 3. Data are transmitted over the telephone network via a modem at the computer and either a directly connected modem or an acoustic coupler at the terminal. Both arrangements can be compatible with one of the Post Office Datal services but the maximum transmission speeds are different. With a modem at either end a transmission speed of 1200 bits/s (Datal 600) is easily attained. However acoustic couplers are, at present, limited to 300 bits/s (Datal 200). The experimental Viewdata service uses modems and 1200 bits/s. However, an acoustic coupler can be used with any telephone so although slower it is more flexible for the present experimental stage. Eventually a domestic information terminal would be equipped with its own inexpensive modem directly connected to the telephone, providing at least a 1200 bits/s transmission speed. Data from the modem or acoustic coupler are transferred via the input interface to a memory (7 bits per character) and subsequently displayed at 24 rows of 40 characters on a 625 line TV picture. This format is identical to that for Teletext and, in principle, can include all Teletext facilities such as colour and graphics.



A one-page memory in the terminal requires about 7 k bits of semiconductor storage. Additional storage of a few more pages could easily be provided and would allow, say, the index to be held ready for immediate access. However, for longer term storage of many pages, a different medium is required. MRL have used an ordinary unmodified audio cassette recorder (figure 5) to store up to 360 pages on a C60 cassette (at up to 1200 bits/s). The data is recorded by frequency shift keying (FSK) where a '1' \approx 3 kHz and a '0' \approx 5 kHz. The complete modem is given schematically in figure 4. The modulator is basically a VCO (Voltage Controlled Oscillator) and the demodulator a phase locked loop. With a supply of 12 V the total dissipation is 200 mW including the voltage regulator. Error rates so far are low (less than 1 in 10^6 bits) at 300 baud but are a little higher at 1200 baud due to jitter.

Future home information terminals

Circuits for displaying Teletext and data from telephone lines are likely to be similar. In particular, the memory, character generator, etc. may be identical. In time, however, there may be not only Teletext and Viewdata but also alternative sources of data available by telephone, by cable or from (e.g.) recorded tapes. Terminals may also need



to include multi-page memory and hard copy print out. Such terminals would require more processing power than is available in this experiment. Microprocessors appear to be suitable for carrying out most of the required decoding and control of peripherals.

Our second generation terminal is therefore being designed to incorporate a microprocessor which gives flexibility to investigate a number of these possibilities. It also could be regarded as a step towards the home computer of the future.

Mullard Research Laboratories,
Cross Oak lane,
Redhill, Surrey

ELEKTUUR

the Dutch edition of Elektor



We look forward to meeting you at the forthcoming radio show in Amsterdam. Our stand is number 17 in the South Hall.

QUADRILLE

*Quadriella. Squara danca for four couplas and containing five figures.

For some time now, discussions concerning the choice of the quadrophonic system of the future have born a close resemblance to a traditional square-dance*. The various partners (= proponents of the various systems) are initially lined up opposite each other on four sides of a square. During the dance, they regularly take a few steps towards each other, bow gracefully, sometimes even link arms for a few moments — but always finish up by retreating to their original positions In this article, we will attempt to define these original positions, by describing in a few words the basic ideas behind each system — as we have understood it, that is. Finally, we will also state our own thoughts on the matter.

(Read on at the top of the next page).

MUSIC OF THE SPHERES—MUSIC OF THE SPHERES

Several tools have been proposed for evaluating and comparing quadrophonic matrix systems. For those of us who are not gifted mathematicians, but who like to 'see' what is happening, the 'energy sphere' approach suggested by P. Scheiber can be quite useful.

Basically this is a way of mapping any two-channel matrix on the surface of a sphere (figure 1A). For a specific combination of the two signals (L_T and R_T where T stands for transmission), corresponding to a specific (intended) image localisation in quadrophonic reproduction, the position on the sphere is determined by the amplitude and phase relationships between these channels.

First, consider the semicircle that runs horizontally round the front of the sphere (the right-hand side in figure 1A) from 'R' through 'F' to 'L'. Looking from directly above the sphere we would see a circle as in figure 1B; the semicircle is the right-hand half of this. The amplitude relationship between L_T and R_T determines the position on this circle. To give a few examples: R_T = 1 and L_T = 0 corresponds to point 'R'; R_T = L_T corresponds to point 'F'.

Next, consider that we rotate this semicircle around the R-L axis. If we turn it right around this axis once, we will have 'wiped' every point on the surface of the sphere. The angle over which we rotate it corresponds to the phase shift between the two channels. This is illustrated in the side view of the sphere shown in figure 1C.

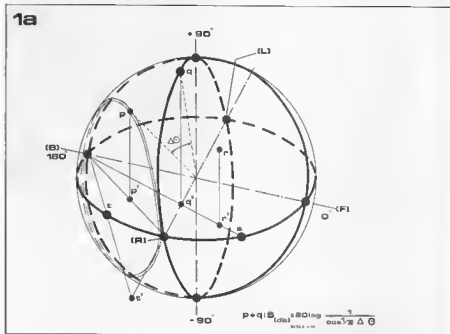

Having plotted a particular matrix in this way, it is possible to estimate its mono and stereo compatibility (amongst other things) quite easily: — **mono gain uniformity.** The distance from point 'F' to any particular point on the sphere determines the (relative) gain for this point.

Referring to figure 1A: all points on the vertical circle through points 'L', '+90°', 'R' and '-90°', are equidistant from point 'F', so a system which plots on this circle (or parallel to it)

will have position-independent gain. — **stereo image localisation.** To estimate the position of the phantom image that corresponds to a certain point on the sphere when the two channels are reproduced as stereo, proceed as follows: Project the point on the sphere down or up on to the horizontal plane through 'R', 'F' and 'L' (in figure 1A, P is projected as P', Q as Q' and R as R'). Now consider this horizontal plane as shown in figure 1B. Draw a connecting line

In the past few years several hundred articles and reports have been written about quadrophonic systems. The various systems have been described, criticized, modified, compared, and defended - but there is still apparently very little agreement as to what type of system is best.

The fundamental problem seems to be the Law of Conservation of Misery: if a system is designed to do one thing almost perfectly, it will necessarily do some other things less perfectly. To give an example: if a system is cheap and gives good stereo compatibility, it may give poor quadro or mono. If the quadro or mono quality is improved, the stereo compatibility will suffer - or the cost price will go up.

When designing a quadro system, the first thing to decide is which factors are of prime importance and which are secondary. If the importance attached to the various factors differs from one designer to the next, they will each come up with a different system. Furthermore, they will each maintain on technical grounds that their own system is the best possible for quadrophonic reproduction - probably without realising that they each have a different concept of the 'ideal quadrophonic system'. And so we arrive at SQ, QS, CD4, UD4, Ambisonics,



etc.

With this in mind, it would appear that the only way to evaluate the various systems is to first try to discover what they are supposed to do; next, decide whether this design aim is desirable; and, finally, find out how well the final

system fulfils the aim.

SQ

The basic design goal for SQ-quadro appears to be as follows. The present-day level of technology is such that stereo long-playing records

HERES-MUSIC OF THE SPHERES-MUSIC OF

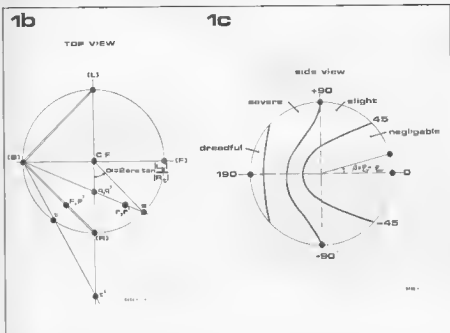

between the point you are interested in and point 'B' on the outer circle. The intersection of this line and the line through 'L' and 'R' corresponds with a reasonable degree of accuracy to the position of the phantom image between the stereo loudspeaker pair, if the loudspeakers are located at points 'L' and 'R'!

In the examples shown, the 'phantom stereo image' corresponding to point P will be located in the right-hand loudspeaker; points Q, R and S

will all be located in the same spot, approximately mid-way between the right-hand loudspeaker and centre-front; point T will be 'located' somewhere out beyond the speaker.

It will be obvious that, if a matrix is to be capable of filling the stereo stage completely, it must include points on the sphere that project onto the connecting lines 'B'-'R' and 'B'-'L'. In other words, it must touch or cross the vertical circles through 'B' and 'R' and through 'B' and 'L'

(the former circle is shown in figure 1A).

- *(stereo) separation.* The effective separation between any two points on the sphere is based on their absolute spherical angular spacing. As an example, the separation between points P and Q is determined by the angle $\Delta\Theta$ (figure 1A). To be more precise the separation in dB is equal to

$$SdB = 20 \log \frac{1}{\cos \frac{1}{2} \Delta\Theta}$$

In particular, this means that any pair of points that are diametrically opposite each other on the sphere ($\Delta\Theta = 180^\circ$) have infinite separation. On the other hand, the separation between two points for which $\Delta\Theta = 90^\circ$ (for instance, points 'R' and 'F') is only 3 dB.

- *'stereo image 'transparency'.* Several listening tests have shown that the 'transparency' or 'focus' of a stereo image depends on the phase difference between the channels (the 'phasiness'). Looking sideways on at the sphere (figure 1C), and speaking very broadly, four zones on the sphere can be defined. For points on the sphere within the zones indicated, the 'phasiness' can be considered negligible, slight, severe or dreadful...

The final sphere, with the various 'phasiness' zones indicated, will now look something like figure 2B. It may be helpful, when looking for the

can be pressed giving extremely high quality reproduction. Stereo is very popular, and likely to remain so for many years to come. The next step is to offer the consumer the possibility of adding an extra dimension in sound reproduction: surround sound. However, this should be done without affecting the high quality stereo reproduction in any way, and at minimum cost to the consumer.

To do this, the original stereo information required for 'surround sound' should be 'painted in with a broad brush' in such a way that it will not interfere with the basic stereo reproduction quality in any way. If quadrophonic reproduction is required, a relatively sophisticated decoder can be used to retrieve the 'surround sound' information and add a feeling of space and ambience to the original high quality stereo. Provided normal record technology is used, the extra cost to the consumer is limited to the outlay for the required decoder, rear channel amplifiers and loudspeakers. The records themselves should not cost more than a normal stereo record.

After some thought and extensive listening, our evaluation of SQ can be summed up as follows

— one of the design aims is to retain

high quality stereo reproduction capability. Very laudable. Furthermore, SQ seems to fulfil this aim: several of the SQ records in our collection give truly excellent stereo.

— SQ uses only two channels for transmission, so existing recording and broadcast technology is not made obsolete. Very laudable.

— The 'surround sound' information is 'painted in with a broad brush'. Definitely true . . . To state one thing quite plainly: in our opinion, SQ reproduced via a basic decoder (without logic) sounds dreadful; we always switched back to stereo very quickly. However, basically the system requires a sophisticated decoder and when this is used the results are not at all bad. We would not go so far as to say that it is the optimum in quadrophonic reproduction, but it can give pleasing results — certainly on 'pop' music. With 'classical' recordings it can give a feeling of 'space', but without sufficient definition to make you think you are in a concert hall, for instance.

QS

The design goal for QS-quadro differs fundamentally from that outlined above.

One of the basic requirements is that it should give quadrophonic reproduction at low cost to the consumer. In this it does not differ from SQ. However, in this case prime importance is placed on the quadrophonic reproduction that can be obtained; stereo reproduction quality is of secondary importance. Furthermore, the demands placed on the quadro reproduction quality are weighted: the front half is considered to be of prime importance, the back is less important.

Owing to a lack of program material, we have not been able to conduct such extensive listening tests in a domestic environment. However, the following points seem evident:

— As with SQ, only two channels are used for transmission, so existing equipment is not made obsolete. Very good.

— Prime importance is given to quadro reproduction, and in particular to the front half. True enough: even when using a basic decoder the results are quite pleasing, although the back half does sound rather like a general mixture of sounds. Using the Variomatrix decoder the results are said to be good, but we have not (yet) been able to test this in a domestic environment.

MUSIC OF THE SPHERES—MUSIC OF THE SPH

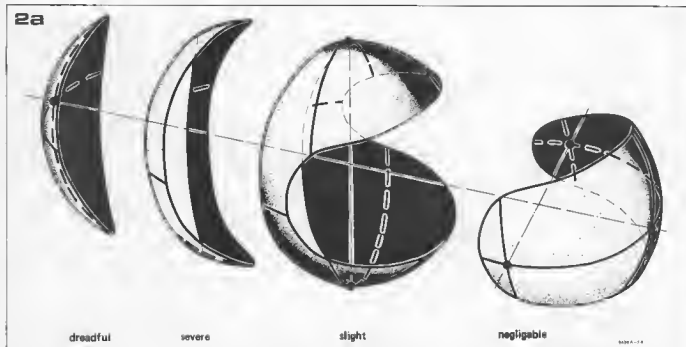

'phasiness zones', to refer to the 'exploded view' shown in figure 2A.

Results for various systems

Once we know what the 'energy sphere' looks like, we can start plotting the various systems on it to see what they will do.

SQ. Figure 3 shows the plot of the basic SQ matrix. Starting at right-front (RF) which is located at point 'R', it follows the 'front' semicircle round to

point 'L' (this is left-front); then up to '+90°' for left-back, down through point 'B' to '-90°' for right-back; and finally back up the side to point 'R'.

From the basic principles it is clear that the 'front stage' from right-front to left-front will fill the complete 'stereo stage' between the stereo speaker pair. It is also obvious that the 'back stage' from the left-back to right-back is in almost the worst possible position as far as 'phasiness' is concerned. Furthermore,

not only is the separation between LF and LB and between RF and RB only 3 dB — there is only 3 dB separation between LB and RF and between RB and LF, i.e. along the diagonals. This is where 'logic' comes in.

In effect, connecting a 'blend' resistor between the LB and RB channels will shift these points along the connecting semicircle towards point 'B'. Similarly, a 'blend' between RF and LF will shift these points forwards towards

- Stereo reproduction is of secondary importance. Quite true. Our experience is that the stereo reproduction is not at all spectacular. The narrow 'front stage' is a definite drawback. However, we fail to see why a modified quadrophonic recording technique (spreading the main front sounds round to halfway up the sides) could not eliminate this for most types of program material. Admittedly, this would once again be a case of enhancing stereo reproduction at the expense of 'accurate' quadrophonic reproduction.

CD-4

The basic design goal for CD-4 is more 'technological' than the two discussed so far: in quadrophonic and stereo reproduction, the sound reproduced by the four loudspeakers in the domestic environment should be as identical as possible to those reproduced by the original monitor loudspeakers in the recording studio. There must be no loss of musical information when the record is played back in mono. The extra cost involved to the consumer is not unimportant, but it is not of primary importance either. In order to achieve the basic design aim, a four-channel transmitting me-

dium must be found. For the four-channel gramophone record (and that's what CD4 is about), the so-called carrier disc technology was developed. Pushing present-day technology to the limit (and, sometimes, beyond the limit...) has led to carrier channel cutting technology, new reproducing cartridges, and sophisticated electronics for distortion and noise reduction and carrier recovery.

The results can be summarised as follows:

- In spite of all the sophisticated technology and electronics, the results we have heard so far have fallen short of the ideal. Dynamic range, signal-to-noise and distortion are (audibly) not yet up to the standard of high quality stereo records. However, the system is still being improved. The most recent commercial pressings are definitely vastly superior to the older ones - and it is said that the very latest experimental pressings are virtually indistinguishable in all parameters from their stereo counterparts. If this is true, we may have finally reached the stage where technology has caught up. However, one still wonders what the results will be in mass production.

- In principle, mono, stereo and quadro reproduction should all be good with this system: if the original signals at the recording end are good (which will probably mean a departure from traditional pan-potting) the final results in the living room must also be good. Once the technological problems are solved, that is.

- The cost to the consumer will probably remain higher than with the first two systems: he must not only buy decoder, amplifiers and loudspeaker, but also a new cartridge (admittedly, these are becoming relatively cheap) - and the records themselves will be more expensive and have a shorter useful life than their stereo counterparts.

- The system is insufficient for broadcast use, certainly in Europe. Four channels just will not fit onto a carrier within the European bandwidth restrictions. This would mean that a different transmission system would be needed for broadcasting CD4 records; the consumer would therefore need two quadrophonic decoders: one for his own collection of CD4 records and one for quadrophonic broadcasts.

UD4

The background of the UD4 system

HERES-MUSIC OF THE SPHERES-MUSIC OF

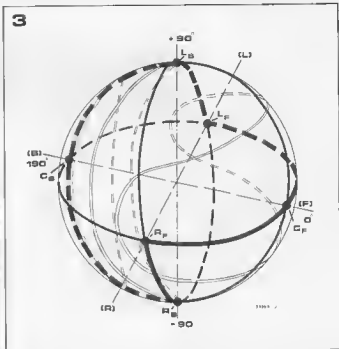
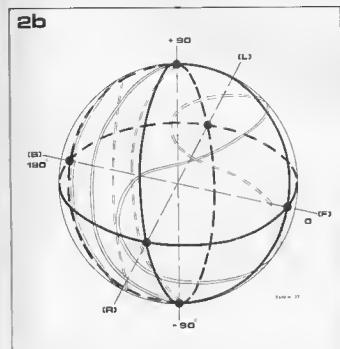

point 'F'. The effect of both these operations is to reduce the separation between the points in question and to increase the separation between front and back and along the diagonals. In a 'logic' decoder, the amount of 'blend' is varied continuously as required to enhance the separation between the dominant sound sources at any particular moment.

QS and RM. The plots for QS and RM are both shown in figure 4. RM

runs exactly round the horizontal circumference of the sphere, through points 'R', 'F', 'L' and 'B'. In mono reproduction, the gain at point 'B' is zero - i.e. it is not reproduced. The QS plot is tilted slightly, so reproduction of sound sources near centre-back is greatly reduced in mono, but no longer zero. From the basic principles of the sphere it will be obvious that stereo reproduction of the front half should not suffer from 'phashiness'. The back half,

on the other hand, runs through the portion labelled 'dreadful'... Furthermore, the front stage (RF to LF) is reproduced on a relatively narrow 'stereo stage'.

BMX. The plot for BMX (the two-channel member of the UD-4 family - the energy sphere is only valid for two-channel matrices!) runs around the vertical 'great circle' from 'R' through '-90°', 'L', '+90°' and back to 'R' (figure 5).

seems to be more mathematical than anything else: it is a system which tries to deal with all possible design aims simultaneously and with equal weighting, and then find the mathematically optimum compromise.

Stereo reproduction is considered equally important to quadro reproduction; cost price is important but not the single most important factor.

The results with UD4 are consistent with the design aims:

- mono and stereo reproduction of UD4 records is quite good, but it is not as good as a high quality stereo record. It lacks 'transparency'.
- quadraphonic reproduction quality depends on the system used: BMX (the two-channel matrix) gives reasonable quadraphonic results for all positions — front, back and sides are all moderate to good. QMX (the four-channel matrix, for which carrier channel record technology is used) is only marginally superior on listening tests, surprising though this may seem. TMX (the three-channel matrix) sounds vastly better than either of the other two options.
- the cost price to the consumer is also intermediate. If the two-channel matrix is used, the hardware cost

should be similar to that for SQ or QS (bearing in mind that no 'logic' or 'variomatrix' is required). It also has the same advantage with regards to not making existing equipment obsolete and being suitable for broadcasting. However, the records should cost approximately the same as CD4 records. The three- and four-channel systems use carrier channel records, and the cost to the consumer will probably be approximately the same as for CD4. If the three-channel system is used for broadcasting, the same decoder can be used for records and for radio broadcasts.

Other systems

In the past few years, some more systems have been proposed. Since we have not yet heard any good demonstrations of these systems, we can only make an educated guess at what the results should be.

The system proposed by the NRDC ('Ambisonics') is based primarily on psycho-acoustic research concerning the 'direction-finding' mechanisms in human hearing. The resultant system would appear to attach more importance to the front half in quadraphonic reproduction than UD4; the back half is treated in practically the same way as in UD4.

Since 'what you gain on the roundabouts you lose on the swings', something else must suffer — and in this case it is the stereo image width. However, the results might well be comparable: more transparency over a narrower stage. The system proposed by the BBC is similar in some ways to Ambisonics. However, in this case the stereo image width is broadened; the loss in this case is that the system cannot readily be extended to use of more than two transmission channels, so it is not capable of further improvement at a future date.

What of the future?

Our impression is that discussions on quadraphonic systems are still going round in (vicious) circles. We feel that the first thing to resolve is the question: What general class of quadraphonic reproduction do we want?

To be more specific: What is the relative importance of each of the following parameters?

- 1) for mono: gain uniformity;
- 2) for stereo: image width, overall;
- 3) for stereo: image width for the front quadrant;
- 4) for stereo: 'transparency' (in theoretical discussions: 'phasiness');
- 5) for stereo: symmetry;

MUSIC OF THE SPHERES—MUSIC OF THE SPHERES

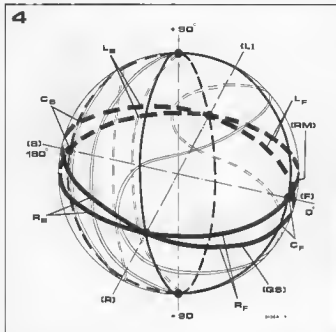

The mono gain uniformity for a matrix of this type is ideal: unity all the way around. Furthermore, the stereo 'sound stage' corresponding to the front quadrant of the quadraphonic sound field is relatively wide, although it does not extend right out to the stereo loudspeakers. Regrettably, the plot for the 'front' (and 'rear') sounds runs through the area where the 'phasiness' is slight, and even touches the 'severe' zone for centre-front and centre-back. There is a case here for tilting the

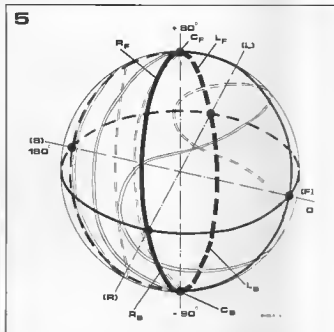

plot forwards slightly so that centre-front comes further into the 'slight' zone.

BBC. This matrix (figure 6) would appear to be based on the 'energy sphere' theory outlined above! The plot for the front quadrant and most of the sides is confined to the zone where 'phasiness' is negligible; the rest is in the 'slight' zone. The 'front stage' is fairly wide in stereo. The plot runs through points 'L' and 'R' thereby guaranteeing a stereo image that will extend out to

the stereo loudspeaker pair. The gain uniformity in mono is quite good. The plot is sufficiently close to a 'great circle' to give good quadro reproduction without resorting to complicated electronics.

It seems too good to be true... and, regrettably, mathematicians assure us that there is a 'snake in the grass'. A curved plot like this one makes it very difficult to add a third channel at a later date to improve quadraphonic reproduction. And thus a great idea

- 6) for quadro: 'transparency';
- 7) for quadro: position accuracy;
- 8) in general: mono compatibility;
- 9) in general: stereo compatibility;
- 10) in general: good quadro reproduction;
- 11) in general: possibility of extension to 'with-height' reproduction;
- 12) in general: compatibility with conventional broadcasting;
- 13) in general: compatibility with present-day level of technology;
- 14) in general: cost price.

To give a few examples:

If a cheap system is required that will give extremely good stereo and acceptable quadro on most program material, and if a future extension to 'with-height' reproduction is not considered, an SQ-like system may well prove to be the best bet.

If a system is required that will transmit the original signals from the recording studio to the listener with minimum changes, if extension to 'with-height', broadcast compatibility and cost price are of secondary importance, and if we are furthermore prepared to accept that it may take several more years for technology to catch up with theory, CD4 may well be the best system.

If a system is required that is capable of giving good quadrophonic reproduction (or even, at a future date,

'with-height') and which is furthermore fully compatible with a cheaper system giving acceptable quadro reproduction and suitable for broadcasting, and if we are prepared to accept that stereo reproduction will not be quite as good as we are used to from high quality stereo records, then a system like UD4 or Ambionics might be best.

In our personal opinion, for what that is worth, approximately equal importance should be attached to the parameters 2, 4, 6 (for the front half) 9, 10, 12, 13 and 14. This might mean a midway compromise between QS and UD4 for the two-channel matrix, and use of CD4 technology to add a third channel as in UD4. This adds up to a fairly close approximation of Ambionics, but it is not necessarily identical! An alternative compromise would be available if CD4 really has solved its technological problems: choose CD4 for records, and use a two-channel matrix for broadcasting (and, if required, for a cheaper range of records at the same time); owing to the different importance attached to the various parameters in broadcasting, SQ might also be an interesting candidate in this field.

One final note: we feel that the possibility of adding 'with-height' information to a conventional gramophone record is unlikely to be of importance —

by the time we get round to that, the conventional record may well be on its way out In another 10 to 15 years we may see the last Long Playing records in museums beside Edison's wax cylinders!

Literature:

- 'Quadro 1-2-3-4. . . or nothing?', *Elektor 1, December 1974, p. 33*;
 'Quadro in practice' *Elektor 4, June 1975, p. 646*;
 'CD-4', *Elektor 8, p. 1224*;
 'From Stereo to Quad', elsewhere in this issue;
 'Quadraphony, an anthology of articles in the JAES';
 'Quadraphony, its potential and its limitations' (Dr. H-W. Steinhausen), *the Gramophone, November 1972, p. 880*.

M

HERES-MUSIC OF THE SPHERES-MUSIC OF

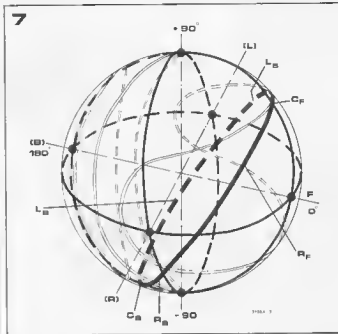
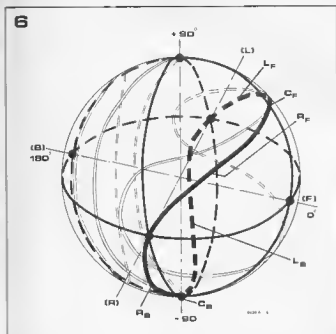

dies before reaching maturity. . .

Ambionics. This system is the one developed by the NRDC. We have deliberately saved it to the last, since it is the most recent to be announced and seems the most promising. The plot (shown in figure 7) can be considered as a BMX plot, tilted forwards and moved forwards off the great circle.

To start with the obvious disadvantage: the fact that it is not a great circle means that there are no two points that

have infinite separation. However, based on psycho-acoustic theory, the proponents say 'who cares?'. The basic idea is to create a sound field, using all available loudspeakers, that gives good reproduction. This goal can be achieved using the proposed matrix.

The second disadvantage is that it cannot completely fill the 'stereo sound stage' between the stereo loudspeaker pair. The proponents maintain that this is just as well: listening tests show that 'good stereo reproduction'

cannot be maintained right out to the loudspeakers.

Now for the advantages. Most of the plot lies within the zone where 'phases' is negligible; the rest lies mainly in the 'slight' zone, with only the area near centre-back in the 'severe' zone. Mono gain uniformity is quite good: the plot is sufficiently close to the vertical. The plot also permits extension with further channels, for improved quadrophonic reproduction or extension to 'with-height'.

M



tachometer

This Tachometer adapter was primarily designed to be used in conjunction with the UAA 170 LED meter (Elektor 12, April 1976, p. 441) and will give a clear 'analogue' indication of the number of revolutions made by the car engine. This article gives a short re-cap of part of the original article plus the additional information needed to make a full-fledged Tack.

For some time Siemens has been marketing two ICs suitable for driving analogue LED displays. One of these is the UAA170, a 16 pin IC with 8 encoded outputs capable of driving a column of 16 LEDs. Only one of these LEDs is lit at any time, which one is lit being dependent on the input voltage; as the voltage is increased a point of light will move up the column. The possible applications for LED meters are numerous, but they are particularly useful in applications requiring mechanical robustness, such as use in the presence of mechanical vibrations, which could damage moving coil instruments. Here the absence of moving parts gives the LED indicator not only an almost unlimited life, but also, the ability to follow very rapid input signal changes, since there is no inertia to overcome.

Reference voltage inputs

To establish the input voltage range over which the circuit operates a reference voltage must be applied between

pins 12 and 13 of the IC, with pin 13 being the more positive of the two. The voltage at pin 13 sets the full-scale reading of the meter. For input voltages in excess of the voltage at this point the last LED in the column will light and stay lit. The voltage at pin 12 establishes the lowest reading of the meter. For input voltages equal to or less than the voltage at pin 12 the first LED in the column will be lit.

30 LED display

For applications requiring greater resolution than can be provided by 16 LEDs the circuit may be extended using two ICs as shown in figure 1. Both ICs receive the same input voltage at pin 11 but the reference voltages are arranged so that the first IC operates over the input voltage range of say $0 - \frac{V}{2}$, and the second IC over the range $\frac{V}{2} - V$, where V is the full-scale input voltage. It is necessary to omit the last LED from the display of the first IC and the

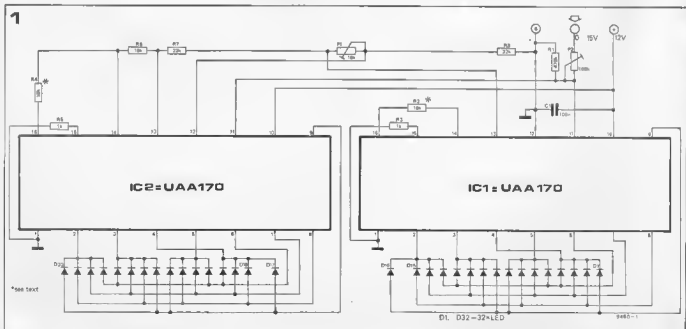

first LED from the display of the second IC, otherwise for voltages in the lower half of the range the first LED of the second IC would always be lit, and for voltages in the upper range the last LED of the first IC would always be lit. For this reason only 30 LEDs may be used, not 32. This means that D16 and D17 should not be part of the scale, although they must be included in the circuit.

So that the omission of these two LEDs does not cause a 'blind spot' in the middle of the display it is necessary to arrange that the second LED of the second IC lights as the 15th LED of the first IC extinguishes. This is accomplished by having the reference voltage on pin 12 of the second IC lower than the voltage on pin 13 of the first IC. The voltage difference between these two points can be adjusted so that D18 begins to light as D15 extinguishes. There should be no blind spot where both LEDs are extinguished, nor should two or more LEDs be fully lit at the same time.

Brightness Control

The output current delivered to the LED display, and hence the brightness, can be altered by a brightness control connected between pins 14 and 16 of the IC. This may take the form of an LDR or phototransistor to adjust the display brightness to suit ambient lighting conditions, or it may be a manual control such as a potentiometer. The control is connected in place of the two fixed resistors R2 and R4. A fixed resistor between pin 15 and ground adjusts the control characteristics of the brightness control.

Figure 2a shows two methods using a photo-transistor, and a LDR. Since there are two ICs in the circuit they would both require a photo-transistor. These transistors must then be mounted in close proximity to each other, otherwise differences in lighting could cause uneven scale brightness. However, it has also proved possible to intercon-

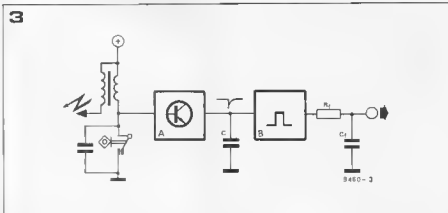
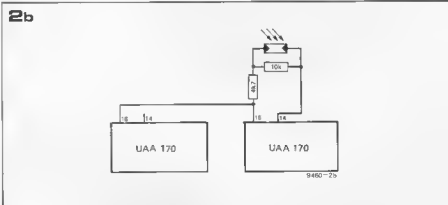
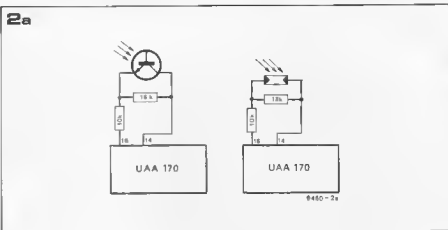

Figure 1. The original LEO meter circuit diagram. D16 and O17 must be included in the circuit, although they can not be used as part of the scale.

Figure 2. Two methods for obtaining automatic display brightness control.

Figure 3. Block diagram of the tachometer.

nect the pins 16 of the two ICs, and use one photo-transistor or LDR between these pins and either of the pins 14. This is shown in figure 2b.

Tachometer converter

The circuit to adapt the LED meter to a full-fledged tachometer need not be complex, a simple monostable multivibrator will do. At the Elektor Labs a simple but effective design was developed using only one 555 IC. This design uses an input stage with one transistor and a filter in the output.

The block diagram of figure 3 gives an impression of how the circuit functions. Due to the fact that the crank shaft and the breaker contacts are coupled the pulse train produced by the breaker contacts is some multiple of the engine's rev's. These pulses are fed to the input stage (block A in figure 3) which, in conjunction with capacitor C, gives them a better shape. After shaping they are used to trigger the monostable multi-

vibrator (block B). For each pulse applied to the input of the monostable, a positive going pulse appears at the output. These positive pulses all have the same width and amplitude irrespective of the input pulse train. As the input frequency goes up, the duty cycle of the output also goes up. These pulses are fed through an integrating filter (Rf and Cf) which changes the pulsed output into a DC voltage with very little ripple. The ripple should be as low as possible because the LED meter responds so quickly that severe ripple on the DC will cause several LEDs to light up 'simultaneously'.

Depending on the number of revolutions made by the engine, the monostable multivibrator will produce many or few pulses per unit time. A low number of pulses will give a low output voltage and a high number of pulses will produce a higher voltage at the filter output. This voltage is displayed by the LED meter.

Parts list for figure 1

Resistors:
R1 = 470 k
R2, R4, R6 = 10 k
R3, R5 = 1 k
R7, R8 = 22 k
P1 = 10 k preset
P2 = 100 k preset

Capacitors:
C1 = 100 n
Semiconductors:
IC1, IC2 = UAA170
O1 ... O32 = LED

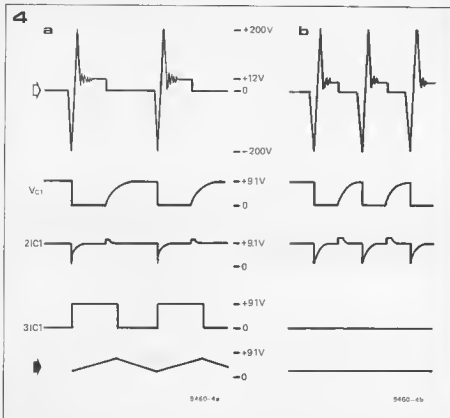

The input stage

The input resistor R1 (figure 5) is connected to the junction of the contact breakers and the ignition coil. R1 and R2 and the zener diode D1 protect the input transistor against high voltages. The moment the contacts open and the plugs spark, an oscillation occurs involving negative and positive peaks of a few hundred volts (see figure 4a, upper voltage form).

During the time that there is a positive voltage across the breaker contact, T1 is driven and the collector voltage drops. IC1 is triggered by this negative edge. Capacitor C1 serves to prevent the 555 from being triggered by short pulses.

The frequency at which the contact breaker feeds pulses to the input stage depends on the type of engine: the 'stroke' number of the engine (two-stroke or four-stroke), and the number of cylinders. The frequency f at which the contact breaker opens and closes is:

$$f = \frac{N}{30} \times \frac{C}{S}$$

where N is the number of revs per min. C is the number of cylinders, and S is the number of strokes in one complete cycle.

So for a four-stroke four-cylinder engine we have:

$$f = \frac{N}{30} \times \frac{4}{4} = \frac{N}{30}$$

At an engine speed of 6000 r.p.m. the corresponding frequency is 200 Hz. By using this formula it is possible to calculate the frequency of breaker pulses for other types of engines. This can be useful when calibrating the instrument.

The monostable multivibrator

The monostable multivibrator is built around the 555 (IC1 in figure 5), an old acquaintance whom we need not introduce again. The IC requires only a few external components for reliable operation. P1, R6, and C3 determine the duration of the output pulses; P1 is variable, so that the circuit can be adjusted to maximum output voltage at a given number of revs. The IC is triggered via pin 2 by means of a short negative pulse (<5 V). Capacitor C2 has been added to ensure that the trigger pulses are of short duration. Otherwise at low engine r.p.m.'s the collector of T1 could remain low longer than the monostable time, and the 555 might then be triggered again. As a result, a multiple of the actual number of revolutions would be indicated. This is prevented by the combination of C2 and R5.

The diodes D2 and D3 ensure that the input voltage at point 2 does not exceed or drop below the supply voltage, as this would damage the IC.

If the output pulses last too long, i.e. longer than the period of the input frequency, but shorter than twice that period, the IC will not yet have returned to the initial position when the next trigger pulse arrives. This will mean that every second pulse has no effect. (The 555 is not re-triggerable). If alternate pulses are lost, it will seem as if the engine is running at only half its actual speed. To prevent this P1 must be adjusted so that the mono-time is shorter than the shortest period (corresponding to the highest input frequency).

5

Parts list for figure 5

Resistors

- R1, R9 = 100 k
- R2, R7 = 1 k
- R3 = 5k6
- R4 = 47 Ω
- R5, R8 = 10 k
- R6 = 3k3
- R10 = 27 k
- P1 = 100 k preset

Capacitors:

- C1 = 68 n
- C2 = 47 n
- C3, C4 = 100 n
- C5 = 100 μ /16 V
- C6 = 22 μ /16 V
- C7 = 2 μ 2/16 V
- C8 = 220 n
- C9 = 10 μ /16 V

Semiconductors:

- T1, T2 = BC 547 B, BC 107 B, 2N3904
- IC1 = 555
- D1 = zener 4V7/400 mW
- D2, D3 = 1N4148
- D4 = zener 9V1/400 mW

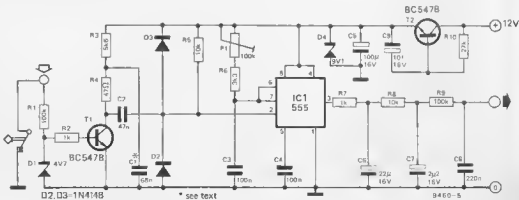

6

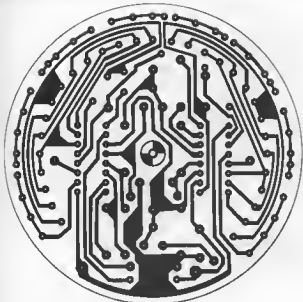
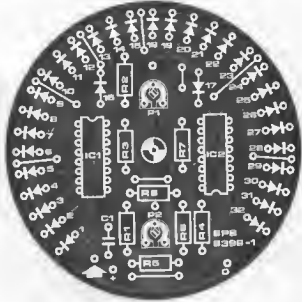

Figure 4. Some waveforms as they occur in the circuit of figure 5. In 4a the trigger pulses on point 2 of IC1 are large enough; in 4b the pulses are insufficient owing to the influence of C1. For the sake of clarity, the ripple voltage at the output is shown exaggerated.

Figure 5. The diagram of the tachometer. The input is connected to the breaker contacts of the car engine; the output drives the LED meter.

Figure 6. The p.c.b. end component layout for the LED meter (EPS 9392-11).

Figure 7. The p.c.b. end component layout of the tachometer (EPS 9460).



The output filter and display

An output filter is not needed in normal rev counters because of the type of readout employed. A moving coil meter cannot possibly follow the pulses of the monostable because of its mass and self inductance.

When using a high-speed electronic read-out however, it is necessary to carefully filter the output to avoid having several LEDs light up simultaneously. This filtering is achieved by a series connection of three RC networks. Consequently, the output impedance is fairly high. This is no problem when it is used with the LED meter, but it is not suitable for a moving coil instrument! The output from the adapter is connected direct to the input of the LED meter (figure 1). Note the value of R1 (470 k); in the original article a different value was shown to obtain a wider input voltage range.

Supply and construction

Although the pulse duration of the square waves at the output of the 555 is practically independent of the supply voltage, it is still necessary to stabilize the supply voltage because the amplitude of the square wave voltage is equal to the supply voltage, thus directly influencing the output voltage of the circuit. Stabilization is provided by means of a zener diode. However, here the usual series resistor for the zener has been replaced by a simulated self inductance (see Elektor nr. 2, page 253) consisting of one transistor. The total current consumption of the circuit remains below 10 mA.

The three p.c.b.s. can be mounted by using a long bolt pushed through the central hole in each board. Spacers are used between the boards.

The whole assembly can now be accommodated in a suitable housing. For this, even a round VIM tin, or something

7

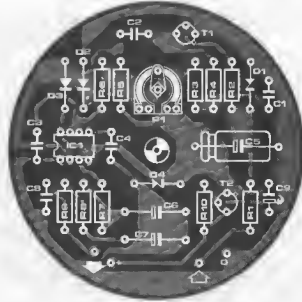

similar could be used. An alternative solution is to build the circuit into a P.V.C. sleeve link for drain pipes (see photograph 3).

Adjustment

The circuit in figure 5 is intended for use with four-stroke four-cylinder engines running at a maximum of 5800 r.p.m. For other engines the highest occurring frequency can be calculated by means of the formula given earlier. C1 is adapted accordingly by multiplying the value from figure 5 by

$\frac{200}{f \text{ max}}$. In most cases the adjustment range of P1 is sufficiently wide to compensate for extreme cases, but C3 can be adapted if required.

A simple adjustment procedure is as follows:

- turn P1 on the tachometer p.c.b. fully anti-clockwise
- turn P2 on the LED meter p.c.b. fully anti-clockwise
- apply the supply voltage (+12 V)
- connect the input to the secondary of a step-down transformer giving 5 to 15 V at 50 Hz
- turn P1 on the tacho board until the read-out indicates 1500 r.p.m. (50 Hz corresponds to $\frac{50}{200} \cdot 6000 = 1500$ r.p.m.).

This completes the adjustment, and the circuit can be built into the car. Owners of an audio signal generator can follow a slightly different adjustment procedure:

- turn P1 and P2 anti-clockwise
- apply a frequency to the input which is 10% higher than the maximum occurring frequency
- Turn P1 clockwise, the readout should be slowly increasing; at some point the readout will jump back to about half reading; leave P1 at this setting
- now apply a frequency which corresponds to the fastest revs possible, the readout should now have jumped back up to almost the correct reading

8

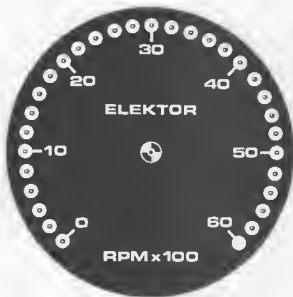

Figure 8. Front panel (EPS 9392-2).

Photo 1. This photograph clearly shows the linearity of the rev. counter. The output (1 V/div) is plotted as a function of the frequency of the input signal (40 Hz/div.)

Photo 2. The complete p.c.b. of the tachometer.

Photo 3. A possible suggestion for the assembly of the entire rev. counter. Because this is a demonstration model, the spacing between the boards is excessive.

- adjust P2 to a correct r.p.m. indication.

If the r.p.m. reading in the car suddenly jumps over to double-value indication, this can be remedied by experimenting with R1 on the tachometer board. The latter should, however, never be less than 4k7.

If the reading suddenly changes over to half-value indication, P1 is not properly adjusted, and the entire procedure must be repeated.

1



2



3



rev counter and dwell meter

C. Wunsche

A rev counter and dwell meter is a useful service aid when setting up the ignition timing of a car, especially in conjunction with a stroboscopic timing light. The instrument described here will indicate dwell angle as a percentage of the complete timing cycle and will measure engine r.p.m. in two ranges that are selected automatically depending on engine speed. The circuit can also be used as a voltmeter for general checking of the electrical system.

The complete circuit of the meter is given in figure 1. With S1 set in position 1 the instrument functions as a dwell meter. Pulses from the car contact breaker are fed into point A and are clipped by R1 and D1. R2 and C1 form a low-pass filter to suppress noise due to arcing and contact bounce. The relatively clean pulses are then fed into emitter follower T4 which drives Schmitt trigger N1. D2 limits the maximum positive input to T4 to about 5.6 V.

Pulses from the output of N1 are fed via a potential divider R4-R6/R7 to the base of T3, which has the meter connected in its collector circuit. The average current through the meter is proportional to the percentage dwell angle, i.e.

$$\text{meter current} = \frac{\text{dwell time} \times 100\%}{\text{total timing cycle}}$$

C5 prevents jitter of the meter needle at low engine speeds.

Rev. Counter

With S1 in position 2 the circuit functions as a rev counter with two r.p.m. ranges (0 - 1500 and 0 - 6000 r.p.m.). Monostables IC2 and IC3 are triggered by N1; IC2 produces a 2.5 ms pulse, while IC3 produces a 10 ms pulse. T1 and T2 form a transistor pump and integrator. So long as the r.p.m. remain below 1500 the collector voltage of T2 will not rise above the threshold of Schmitt trigger N2. The output of N2 will be high and 10 ms pulses from IC3 will pass through N5 and N6 to the base of T3.

At engine speeds in excess of 1500 r.p.m. the output of N2 will be low so the pulses from IC3 will be blocked and 2.5 ms pulses from IC2 will pass through N4 and N6. LED D4 indicates that the meter has switched over to the higher range. The hysteresis of the Schmitt trigger prevents jitter between the two ranges at the changeover point by ensuring that the engine speed must drop well below 1500 r.p.m. before the

circuit will switch back to the lower range.

Apart from the automatic range change the rev counter operates in the normal way. Since the output pulses from the monostables are of constant width, as the r.p.m. increase the pulses will get closer together and the duty-cycle will increase, thus increasing the average current through the meter. The 4:1 ratio of the monostable pulse lengths gives a 4:1 relationship between the two meter ranges.

Voltmeter

With S1 in the third position the circuit will operate as a voltmeter with a full-scale deflection of 18 V. A multiplier resistor R8-R10 is simply connected in series with the milliammeter and the voltage to be measured is connected between point L and 0 V.

Power supply

The 5 V power supply required by the circuit is obtained from the car battery via a 5 V IC regulator IC5. A diode D3 in series with the regulator input protects the circuit against damage in the event of the supply leads being accidentally reversed.

Construction and calibration

A p.c. board and component layout is given in figure 2. Before calibration the meter face should be marked up with the scales 0 - 100%, 0 - 1500 r.p.m., 0-6000 r.p.m. and 0-15 V.

The assembly is quite straightforward, the only unusual point being the use of fixed calibration resistors instead of preset potentiometers. In the interests of reliability in the adverse conditions under which this circuit is likely to be used, and to avoid possible tampering by unskilled users, it was decided not to use presets for calibrating the instrument, but to use selected fixed resistors. This should not cause any problems as



the calibration procedure is quite straightforward and need be done only once during the lifetime of the instrument.

Dwell. Calibration of the dwell meter is very simple. S1 is switched to position 1 and the input, point A is temporarily shorted to ground. This corresponds to the condition where the points are permanently closed, i.e. 100% dwell. A decade resistance box or potentiometer is connected across R4 and is adjusted to give full-scale deflection of the meter. A fixed resistor or parallel combination of resistors is then substituted for the resistance box and is soldered in place in the R5, R6 positions.

r.p.m. To calibrate the rev counter the automatic range selection must first be disabled by shorting the junction of R23, R24 and C4 to +5 V. This will keep the instrument on the 0-1500 r.p.m. range. With S1 in position 2 an input signal is provided by connecting the secondary of an 8 V 50 Hz mains transformer between point A and ground. This corresponds to an engine

speed of 1500 r.p.m. for a four-cylinder four-stroke engine and 1000 r.p.m. for a six-cylinder four-stroke engine. For other engines the following equation can be used:

$$f = \frac{N \cdot c}{30 \cdot s} \text{ Or}$$

$$N = \frac{30 \cdot f \cdot s}{c} \text{ where}$$

f = frequency at point A
N = engine r.p.m.
c = number of cylinders
s = 4 for four-stroke and 2 for 2-stroke engines

The 1500 r.p.m. range can now be calibrated in the same manner as the dwell meter by connecting a resistance box or pot across R11 and adjusting it until the meter gives the correct deflection for the type of engine to be used. (In this case N (r.p.m.) = 1500 s/c). Fixed resistors to an equal value may then be substituted and soldered into the R12, R13 positions.

The shorting link is now removed from the junction of R23, R24 and the automatic range change can be calibrated.

With signal applied that corresponds to 1500 r.p.m. R26 should be selected so that the range just changes. If a signal generator is available this can be checked by varying the frequency up and down about the changeover point. The '1500 r.p.m.' test signal can be the same 50 Hz input for 4-cylinder 4-stroke or 2-cylinder 2-stroke engines. For other engine types a signal generator can be used, or, alternatively, the unit can be connected to the car engine. The 6000 r.p.m. range can be calibrated by using the same 8 V transformer, and connecting a bridge rectifier between its secondary winding and the input to the rev counter. This gives a 100 Hz input, corresponding to an r.p.m. reading that is twice that in the previous case. R15/R16 are now selected in a similar manner so that the correct reading (e.g. 3000 r.p.m. for 4-cylinder 4-stroke) is obtained on the 6000 r.p.m. range.

Voltmeter

If a multimeter is available the voltmeter can be calibrated by connecting

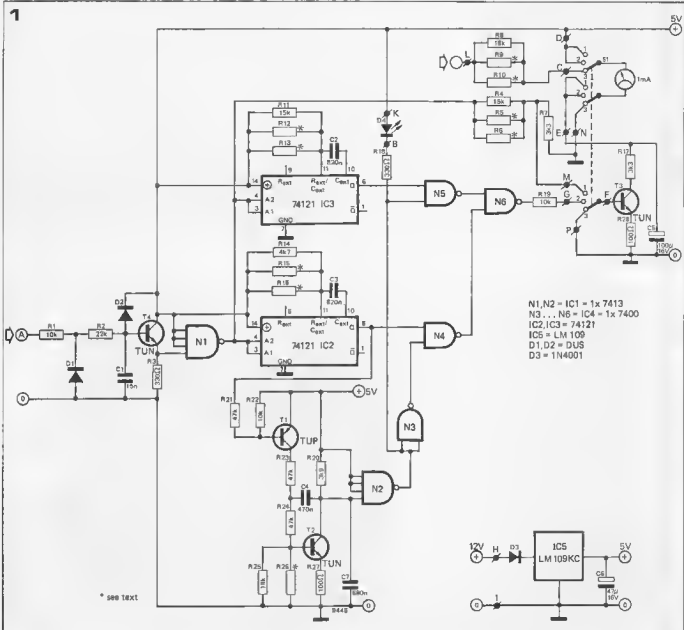

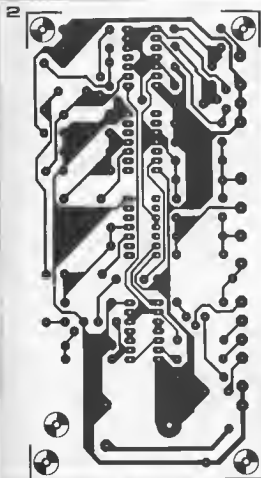
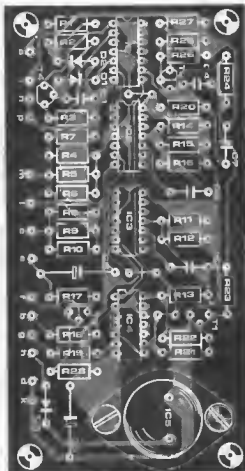

Figure 1. Complete circuit diagram.

Figure 2. Component layout and printed circuit board (EPS 9449).

Figure 3. Completed unit.



Parts list

Resistors:

R1, R19, R22 = 10 k
 R2 = 22 k
 R3, R18 = 330 Ω
 R4, R11 = 15 k
 R5, R6, R9, R10, R12, R13,
 R15, R16, R26 =
 see text
 R7, R17 = 3k3
 R8, R25 = 18 k
 R14 = 4k7
 R20 = 3k9
 R21, R23, R24 = 47 k
 R27, R28 = 100 Ω

Capacitors:

C1 = 15 n
 C2, C3 = 820 n
 C4 = 470 n
 C5 = 100 μ /16 V
 C6 = 47 μ /10 V
 C7 = 680 n

Semiconductors:

T1 = TUP
 T2 ... T4 = TUN
 IC1 = 7413
 IC2, IC3 = 74121
 IC4 = 7400
 IC5 = LM 309KC (5 V, 1 A)
 D1, D2 = DUS
 D3 = 1N4001
 D4 = LED

Miscellaneous:

S1 = 3-pole 3-way switch
 M1 = meter, 1 mA f.s.d.

them both across the car battery and selecting R9/R10 so that the voltmeter reading corresponds with the multimeter reading. If a multimeter is not available then simply use a 15 k 2% resistor in place of R8 when the full-scale deflection of the voltmeter will be about 15 V. \blacksquare

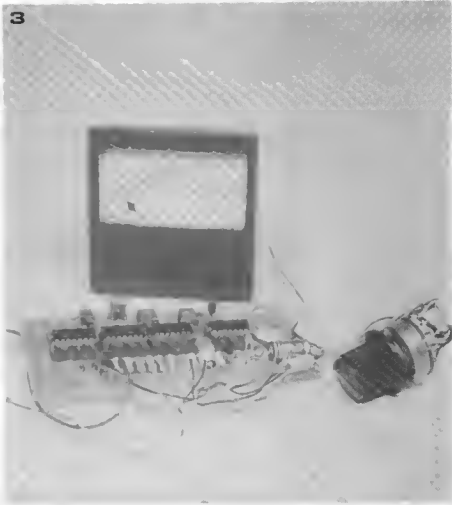

windscreen wiper delay circuits and how to install them

When driving in a very light rain one finds that the wipers have to be continually switched on and off to remove the small quantity of water on the windscreen. This is usually accomplished in one or two sweeps and then the wiper blades proceed to grate and screech, obviously not good for the wiper blades or the windscreen itself.

The obvious answer is to find some way to automatically switch on the wipers every once in a while. This article describes two good 'delay' circuits and the way to connect them into a car.

(This article is based in part on an article submitted by Mr. A.J. Cartwright).

Many articles have been published describing the 'end-all' windscreen wiper delay circuit. Often these circuits are capable of doing a good job. In fact, everything usually goes well until the constructor gets to his car.

There, a large and bewildering bundle of wires connects what was thought to be a simple on-off switch, to what was thought to be a simple motor. A quick glance at figure 1 shows where some confusion comes from. There are many different wiper systems, using a wide variety of switching configurations. However, an investigation of figure 1 will show that all electrical wiper systems have common operating ideas.

It can be seen that all systems have a switch (designated 'H' in figure 1) that is coupled to the motor. This is a cam operated micro-switch which is used to 'self-park' the wipers after they have been switched off at the dashboard. To this end, power is maintained via H until the wipers are in the correct position to stop.

Further analysis of figure 1, confining the discussion to the first column for the moment, will show that there are two basic wiper circuits. Figures A1 and B1 show the simplest type, used mostly in older cars: a simple on-off switch connected in parallel with the self-park micro-switch.

The other basic circuit (figures C1, D1, E1, F1, G1 and H1) is more complex, and is used in newer cars. When the motor reaches the desired 'off' position, the power is switched off and a short circuit is connected across the motor. In this way, the back EMF of the motor is used as a brake. Without this type of braking, the wipers would overshoot the self-park position and begin another wipe cycle.

Figure 1C1 shows the simplest form of the shorting system. First, let us assume that the wipers are turned on. (Contacts Sa are closed and Sb are open). When the dashboard control is switched off, contacts Sa open and Sb close. Power to the motor is maintained via micro-switch H until the wipers reach the self-park position. At that moment the micro-switch removes the power from the motor and connects the short instead via Sb.

The other circuits (figure 1D1 to 1H1) are all variants on the same principle.

The other circuits shown in figure 1 are all easily derived from the basic circuits already described. The top two rows are all variants on the simple basic circuits (figures A1 and B1); the rest are all variants on the more complex shorting system.

In each case, the first column shows the one speed system with the switching taking place in the positive lead.

The second column is the same one

speed system, but with the switching in the negative lead.

Column three is the two speed wiper with positive switching while column four is two speeds with negative switching. Column five shows one possible place to connect the delay circuits.

If an electrical diagram of the car is not available the first thing to be done is to make a trip to the car, taking along a multimeter. Making voltage measurements to the wiper switch and comparing the findings with figure 1, it should be possible to determine which type of system is used.

Once it is known what wiper system is in the car, a suitable delay system can be chosen. For the simple wiper system all that is needed is an on-off device. For the more complex system this will not be sufficient: if the power is applied before the short is removed, sparks will fly. Therefore, the short must be either removed or altered in some way before applying power. The fifth column in figure 1 shows the basic principle of where to add additional (automatic) switches, driven from the delay circuit.

Figure 1: Survey of possible wiper switching arrangements. The first column gives the basic circuits; columns 2, 3 and 4 show variants on the basic circuits and column 5 shows where to connect the additional 'switches' that form part of the delay circuit.

1

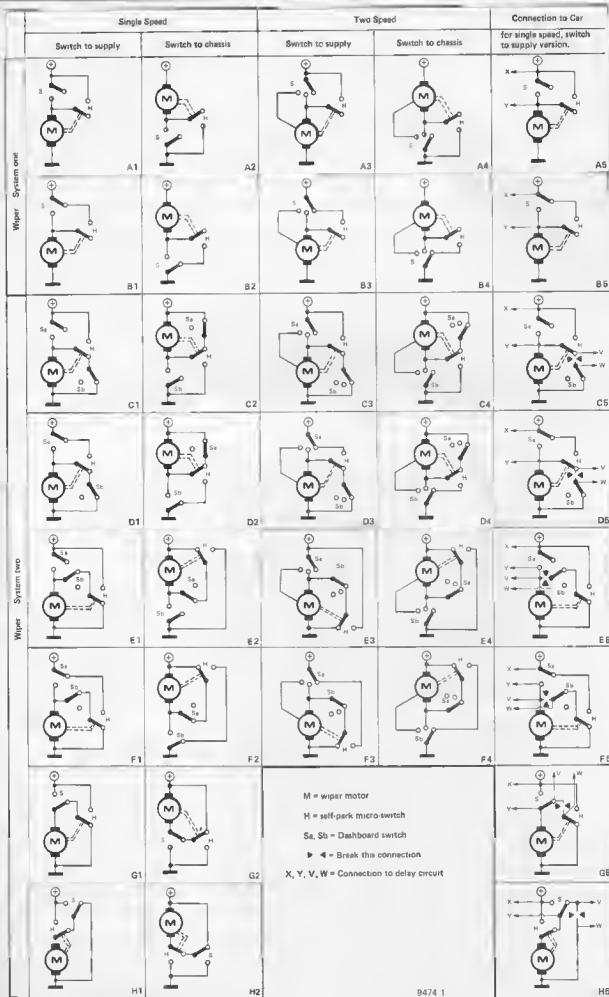

2a

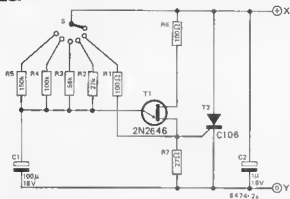

2b



A simple practical circuit

If the original wiper circuit corresponds to one of the circuits shown in figure 1A or 1B, the simplest delay circuit shown in figure 2 can be used. This is a straightforward circuit that gives very satisfactory results. It is possible to use this circuit on either 6 or 12 V cars with no modifications.

After power has been applied, the R-C time constant of R2 . . . R5 and C1 determines the delay before turning on a UJT. This in turn fires the SCR, which allows current to flow to the motor. When the motor starts to turn, the self-park micro-switch shorts across the SCR. This resets the circuit.

Connection to the original wiper circuit in the car is very simple: connect

3

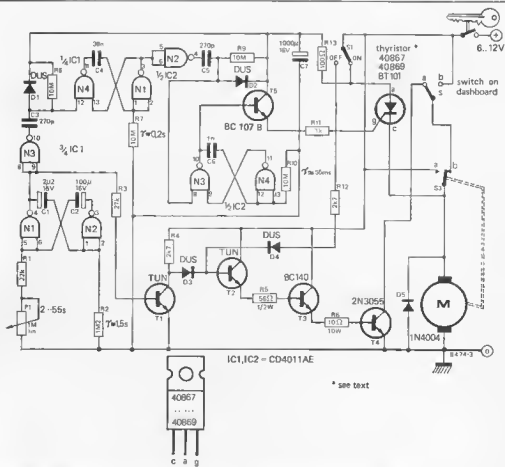

IC1, IC2 = CD4011AE

* see text

4

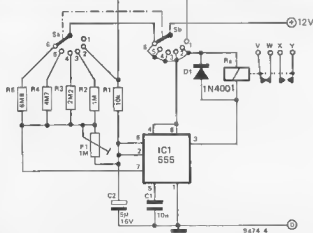

point X (figure 2) to point X (figure 1), and point Y to point Y.

This simple circuit may also be used with most of the complex wiper systems, provided a high wattage car headlamp is added in series with the shorting lead. The lamp lends itself to this job because of its positive temperature coefficient (PTC). When the lamp is cool (passing no current) its resistance is very low, a good short. However, when warmed the resistance goes up. This means that when the SCR is first turned on it must deliver a heavy current into the lamp and the motor, connected in parallel. The SCR should have an adequate maximum current rating. However, the lamp will heat up rapidly so that its resistance rises and the power dissipated in the SCR will drop rapidly. Once the

Parts list for figure 2.

Resistors:

R1, R6 = 100 Ω
 R2 = 27 k
 R3 = 56 k
 R4 = 100 k
 R5 = 150 k
 R7 = 27 Ω

Capacitors:

C1 = 100 μ /16 volts
 C2 = 1 μ /16 volts

Semiconductors

UJT = 2N2646, mu 10
 SCR = 6 A/100 V

Sundries:

switch: single pole, six-way
 lamp: 12 volt/40-45 Watt (car headlamp)
 for 12 V car,
 6 volt/40-45 Watt (car headlamp)
 for 6 V car.

Parts list for figure 4.

Resistors:

R1 = 10 k
 R2 = 1 M
 R3 = 2M2
 R4 = 4M7
 R5 = 6M8
 P1 = 1 M

Capacitors:

C1 = 10 n
 C2 = 5 μ /16 V

Semiconductors:

D1 = 1N4001
 IC = 555

Sundries.

Relay: 12 volt, Break before make
 contacts.
 Contacts: one make, one break
 Contact rating: 5 Amp.

Switch: two-pole, six-way

Note: use 12 V relay for 12 volt cars.
 and a 6 V relay for 6 volt cars.
 Caution: 555 max. output current
 is 200 mA

motor starts to turn the short is removed by the self-park micro-switch. The lamp goes out and its resistance goes down to the low 'cold' resistance. When the short is needed at the end of the wipe, it's there and the wipers will stop.

A not-so-simple circuit

For those who wish to build an all-solid-state system, not using the headlamp trick, figure 3 would do the job. In figure 3, a thyristor is used for the on-off function and a transistor (T4) is used for the short. The extensive logic circuitry is mainly required to ensure that the SCR and T4 can never be turned on simultaneously. However, it is apparent from the number of components that this circuit will be expensive.

Figure 2a: SCR wiper delay.

Figure 2b: Lamp with connecting points shown.

Figure 3: All solid state delay system.

Figure 4 The best wiper delay circuit using a 555 for the timing and relay driver.

Figure 5 Component layout and p.c. board for figure 2.

Figure 6: Component layout and p.c. board for figure 3.

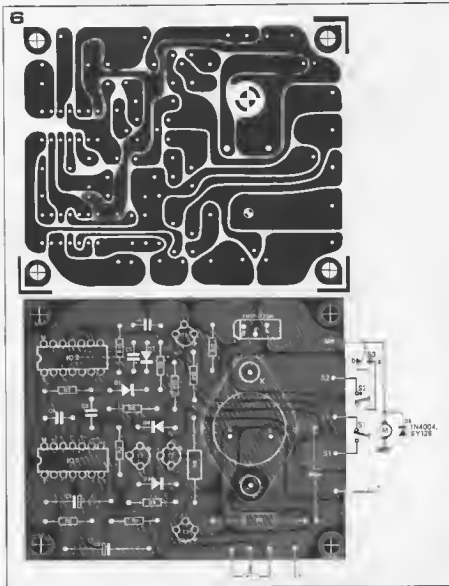
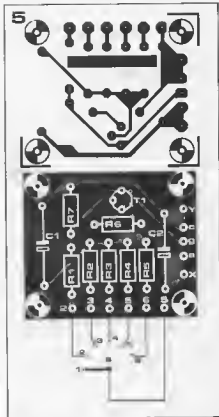

ive to construct. An alternative circuit, with a reduced component count, is called for.

A more practical circuit

An alternative solution to the lamp and the transistors is a relay. A multi-contact relay lends itself to any switching situation which might occur. Figure 4 shows a simple circuit using a 555 timer. The maximum output current of this IC is 200 mA, so it can drive the relay direct. This circuit will operate on 6 or 12 volt cars. The only circuit change is the relay (12 V relay for a 12 V car, 6 V car 6 V relay).

Most circuits using the 555 don't give a wipe immediately after being switched on. To cure this, R1 is included. This resistor keeps the timing capacitor (C2) charged, so that the relay is activated as soon as the delay circuit is turned on.

A further improvement of this circuit over the simple SCR unit (figure 2) is the possibility of having the wipers sweep twice between delays. This multi-wipe function is adjusted with P1.

Connection to the original wiper circuit

As stated earlier, column 5 in figure 1 shows where to include the additional switches required for a delay circuit. So as not to become too redundant only

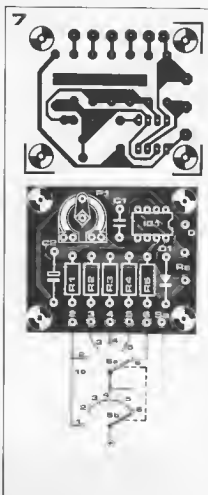

connections to the first example of each type are shown, i.e.: connection to figure 1A1 is shown in figure 1A5; figure 1E1 in figure 1E5, etc.

For wiper systems like figure 1A and figure 1B, the SCR circuit (figure 2) is adequate. It should be connected across the self-park micro-switch.

The delay using the 555 can be used with all wiper systems. The normally open contacts X and Y of the relay are connected across one set of dashboard contacts, and the normally closed relay contacts W and V are connected in series with the shorting lead. For safety reasons, it is advisable to connect the relay into the original wiring in the car in such a way that the dashboard switch will maintain its original function. Then in case of electronics failure the wipers will still work. The circuits shown in figure 1 (fifth column) all meet this requirement. **M**

Figure 7: Component layout and p.c. board for figure 4. (eps 9474 - 2)

SERVO-TAPE

R. Hardcastle

From time to time, the avid home constructor is confronted with the problem of how to mount printed circuit boards into a case. By using a product known as Servo-tape, the mounting of small p.c. boards can be made much simpler and neater.

Servo-tape (also sold as "Tesa-tape") is a foam plastic tape with a self-adhesive layer on both sides, and comes in two thicknesses: 1/8 and 3/16 inches. It is

sold at model shops and is used for mounting servo modules and the like into model aircraft and boats. If the thicker tape is used, it should provide sufficient clearance for the solder joints on the underside of a p.c. board.

The tape is trimmed into squares about 1cm across. One of these pads is stuck onto each corner of the p.c. board, after which the board is ready for mounting into the box. No bolts, no holes. The

appearance of the case is not marred by bolt heads in odd places.

As stated previously, the thicker type of tape should provide enough clearance for most solder joints. However, to provide more space when needed, servo-tape can be stuck to both the top and bottom of a small block of wood as illustrated in the drawing.

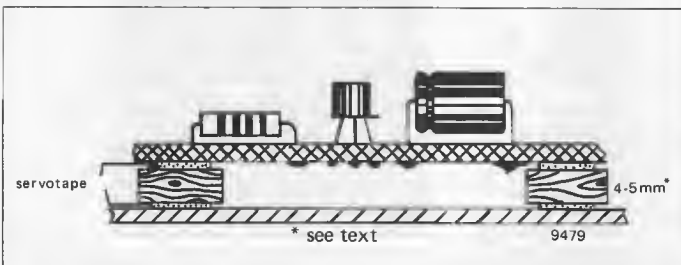

MILES- PER- GALLON INDICATOR

A fuel consumption meter indicating 'miles per gallon' is a useful instrument for economy-minded motorists. By making one minor modification to an existing petrol flow meter made by ABM, the long wished for MPG indicator can become a reality.

There are several special items needed for the construction of a fuel consumption meter. The most important is a sensor that is capable of measuring the fuel flow rate. This type of sensor is not readily available at a 'reasonable price', and it is even harder to make. However, a simple fuel consumption meter has recently been introduced, comprising a flow sensor, a readout device and some electronics in between. This meter, made by ABM-Electronic, is marketed in several countries by ITT Hobbykit Centre for about £ 20. It indicates the fuel consumption in litres per hour.

Although such an indication is better than nothing, some further calculation is required to work out the mileage per gallon from the information available. And since miles per gallon (MPG) is in fact what we want to know, it is not at all unlikely that the motorist will be concentrating on mental arithmetic more than on driving. Obviously, road safety could be better served if the meter could be extended by an auxiliary circuit that will do the arithmetic and give a direct reading in 'miles per gallon'.

In practice, this modification requires

a speed sensor and some additional circuitry. The speed sensor is an ordinary telephone pick-up coil, of the type used for 'loudspeaking' telephones or for taping telephone conversations.

The original fuel consumption meter

Figure 1 shows the ABM fuel consumption meter. Sensor X is the specially designed fuel flow sensor, which must be incorporated in the fuel line between the fuel pump and the carburettor. It produces a pulse signal with a frequency corresponding to the flow rate of the petrol.

This signal is amplified to a suitable level by the TAA 861. Pulse shaping is performed by a simple one-shot (TA/TB), after which the pulses are fed to an integrator built around TC. The emitter of TC drives the meter (M) which is calibrated in litres per hour.

Figure 1. The original 'litres-per-hour' meter. 'X' is the fuel flow sensor.

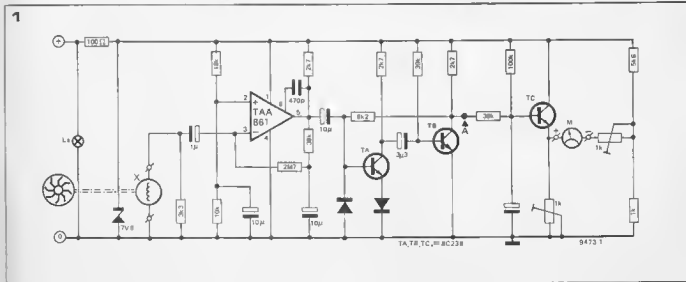

2

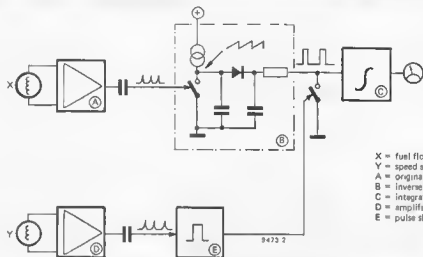

The instrument can be calibrated with the two 1 k preset potentiometers; however, this setting is best left alone for the moment because the instrument has already been properly adjusted in the factory.

The point marked 'A' in the diagram is important in view of the extension circuit now to be described.

Extension of existing meter

If the 'litres per hour' meter, shown in figure 1, is to be extended to a 'miles per gallon' indicator, some sort of miles-per-hour information will be needed. This information will have to be mixed in a suitable way with the original 'fuel flow' signal at point 'A' of the 'litres per hour' meter. The new pulse signal, containing both the 'litres per hour' and the 'miles per hour' information, can then be integrated (TC) and used to drive the meter. This can now be calibrated to read 'miles-per-gallon'.

The block diagram of figure 2 shows how all this can be achieved with only one change to the original circuit: it is split up into two parts (at point A in figure 1) in such a manner that the integrator (block C) is separated from the rest. Blocks B, D, and E are added.

The output signal from the flow sensor (X) is first amplified and shaped in block A - exactly as in the original litres-per-hour meter. The output signal from block A is brought out and fed to block B. This is part of the extension circuit. It generates a saw-tooth signal, the amplitude of which decreases as the repetition frequency of the pulses increases. In short, after detection, block B produces a DC output voltage which is inversely proportional to the fuel consumption.

Sensor Y and blocks D and E are also part of the extension circuit. Since practically all speedometers operate on the eddy current (magnetic friction) principle, a pulse signal can be obtained by means of a simple pick-up coil (Y) in the vicinity of the speedometer. The pulse frequency then corresponds to road speed.

Parts list for figure 3

Resistors:

R1 = 1 k
R2, R3 = 12 k
R4 = 100 Ω
R5 = 3M3
R6, R13 = 47 k
R7, R8, R15, R17 = 10 k
R9 = 5k6
R10, R12, R20 = 1k5
R11 = 33 Ω
R14 = 470 k
R16 = 330 Ω (see text)
R18 = 2M2
R19 = 220 Ω
R21 = 3k3

Capacitors:

C1 = 220 μ /16 V
C2 = 2 μ /4 V
C3 = 220 μ /4 V
C4, C5, C8 = 22 μ /16 V
C6 = 3 μ /16 V
C7 = 470 n
C9 = 2 μ /16 V
C10 = 1000 μ /2.5 V

Semiconductors:

T1 ... T6, T7, T8 = BC107B, 2N3904
T6 = BC177B, 2N3906
D1 ... D8 = DUS
IC1 = 741

Miscellaneous

Y = telephone pick-up coil
P1, P2 = 10 k (preset)
S1 = two-position switch, single pole (SPDT)

The upper part of the circuit is the fuel consumption meter by ABM-Elektrotronik GmbH, 6500 Nürnberg 15, Postfach 150568, West Germany. It includes the flow sensor X, the meter M and the electronics shown in figure 1.

We have been advised that HB electronics now intend to stock these units. See their advertisement elsewhere in this issue for address and telephone number.

The output signal of this pickup is amplified (block D) and clipped, after which a pulse shaper (E) produces pulses of a constant width.

The (DC) output of block B is chopped by the pulse signal from block E. The 'height' (voltage level) of the resulting pulses now contains information concerning the fuel consumption in litres per hour, whilst the frequency (and duty cycle) contains information concerning the speed in miles per hour.

After integration (block C) the meter will indicate MPG.

The circuit

When designing the extension circuit, the main objective was that it should involve the minimum amount of modification to the original instrument.

Figure 3 shows the complete diagram of the modified fuel consumption meter. The upper part of the diagram is the original meter as shown in figure 1. Switch S1 is connected between the output of pulse shaper TA/TB (point A) and the input of integrator TC (point A'). With S1 in the position shown the circuit functions as the MPG indicator; with S1 in the other position only the original litres-per-hour meter is in operation.

Block B of the diagram of figure 2 is formed by the circuit around T4 ... T7. Electrolytic capacitor C8 is continuously charged by current source T6. Each pulse from the flow sensor (point A) turns on transistor T4 briefly, discharging C8. The result is a sawtooth waveform with a peak voltage level that is inversely proportional to the petrol flow: a high fuel consumption rate corresponds to a large number of pulses per second, so that capacitor C8 will be discharged at very short intervals, and hence the amplitude of the sawtooth will remain small; at low fuel consumption rates, on the other hand, the voltage across C8 will rise to a considerable value during the longer intervals between two successive pulses.

miles-per-gallon indicator

This sawtooth voltage is then rectified (D6, C9), producing a DC output from emitter follower T7. The DC-voltage at this point is related directly to the fuel flow rate.

In the above discussion of this part of the circuit, T5 has been intentionally 'forgotten' for the time being. It is an offset control which will be dealt with further on.

As explained, the 'miles-per-hour' information is derived from the speedometer by means of a telephone pick-up coil (Y). This produces a pulse signal with a frequency which is proportional to the speed of the car. This signal is first pre-amplified in opamp IC1 and then 'squared' by trigger T1/T2.

transistor I3 serves as the one-shot pulse shaper (block E in figure 2); the output pulse length is set with P1. The switch function between the outputs of blocks B and E in figure 2 is also carried out by transistor T3. Since this transis-

Figure 2. Block diagram of the miles-per-gallon meter.

Figure 3. The complete circuit diagram of the modified fuel consumption meter. The upper part of the circuit is the original meter. 'Y' is the speed sensor coil.

Figure 4. The input signal of the integrator. 'V' is inversely proportional to the gallons of fuel consumed per hour, whereas 'T' is inversely proportional to the speed (miles-per-hour).

tor opens and closes in the rhythm of the miles-per-hour pulses, the fuel-flow dependent voltage at the output of T7 is sampled, as it were, by switch T3.

The resulting signal is shown in figure 4. The frequency of this pulse signal corresponds to the number of miles per hour, and so period T is inversely proportional to it. V is inversely proportional to the fuel consumption in litres per hour. The pulse width τ is a constant which depends on the setting of P1 in the pulse shaper stage T3.

Summarizing, it will be obvious that after integration (TC), the meter M receives a voltage that will be higher as the number of pulses from the pick-up X per unit time (fuel flow) is lower, and also as the number of pulses from Y (speed) is higher. In other words: both a decreasing flow rate of the fuel and an increasing speed of the car will cause the output voltage of integrator TC to rise, so that the meter

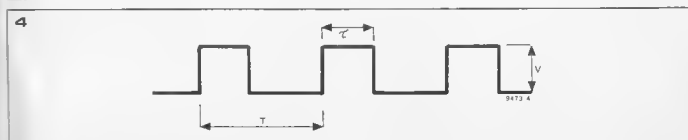
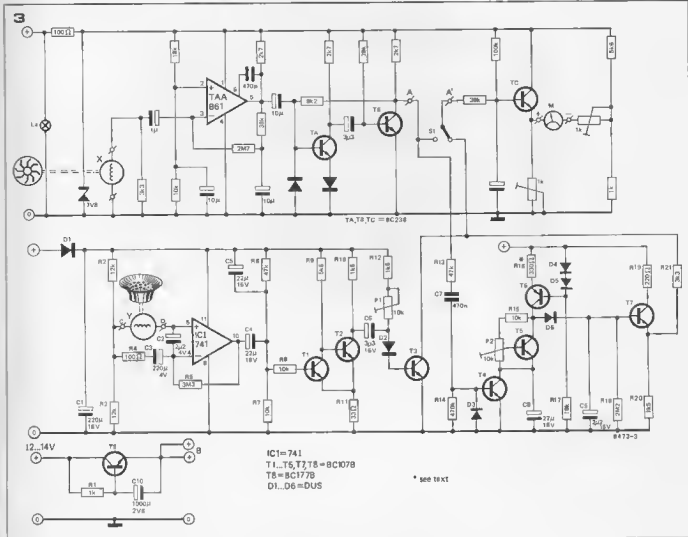

will indicate a higher value, and thus a more economic fuel consumption.

Offset control

When detecting the sawtooth voltage which is derived from the litres-per-hour pulses, a small voltage drop occurs across D6 and emitter follower T7.

At fairly high levels (= low fuel consumption) the resulting error is small. In the case of high fuel consumption, however, this voltage drop will give rise to a considerable measuring error. To compensate for this, an offset-control is included (T5). The offset voltage (set with P2) is added, as it were, to the sawtooth voltage across C8.

Adjustment

There are two ways to calibrate this unit.

If we assume that the original litres-per-hour meter is properly calibrated, a new scale reading gallons-per-hour can be glued over the original one. The conversion factor for this new scale is 4.546 litres per gallon for the UK and anywhere else using gallons, except the USA with 3.785 liters per gallon. This means that in the UK the original full scale deflection will now correspond to 4.40 gallons, which is possibly not the most useful scale.

The other method is a bit more complex, but should prove to be more suitable. With the aid of an audio signal generator connected to the flow sensor terminals, the basic ABM unit can be calibrated to read 5 gallons per hour (f.s.d.). The AF generator should be set for an output frequency of 50 Hz (41.6 Hz for USA) after which the 1 k pot in series with the meter in the basic ABM unit is adjusted until the meter gives a full scale reading. Once the basic unit has been re-calibrated and/or re-scaled, the Elektor unit can be connected to it. Then the completed MPG indicator can be installed in the car. This is discussed in greater detail further on. Calibration now proceeds as follows.

- drive at such a speed that it can be safely assumed that fuel consumption is low, say 30 mph. The fuel flow should preferably be one gallon per hour or less. (NB. See 'final notes!');
- switch the unit to the gallons-per-hour position and read off the fuel consumption. Divide this reading in to your speed, to obtain the correct MPG indication;
- switch to the miles-per-gallon position and adjust P1 so the meter reads properly;
- drive faster, to cause an increase in fuel flow (preferably three gallons per hour or more). Check the GPH, compute the new MPG and adjust P2 to obtain a correct reading.

This procedure is repeated several times, until no further improvement can be obtained.

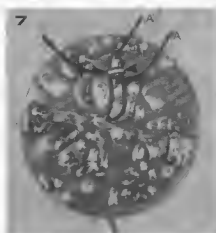
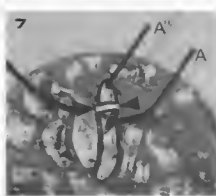
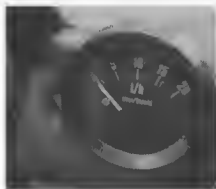

Figure 7. Photograph of the p.c.b. of the ABM meter. The points A and A' are obtained by interrupting the copper track at the place indicated by the arrow.

Range

Obviously, the range of the fuel consumption meter has certain limits. When measuring the flow rate of the fuel, for example, the phenomenon occurs that at a very low pulse frequency from sensor X the voltage across C8 is limited by the supply voltage. Lower flow rates cannot be measured. Similarly, at a certain speed the duty cycle of pulse shaper T3 will reach its maximum (50%). Any further increase of speed will have no effect.

For the component values shown in figure 3 the lowest fuel consumption that can be measured is about ½ gallon per hour; the maximum speed at which the unit will work is about 95 mph.

Reducing the value of R16 will shorten the charge time of capacitor C8. Correct calibration now corresponds to a different setting of P1, which in turn corresponds to an increased maximum measurable speed. At the same time the minimum number of litres per hour that can be measured shifts higher up the scale.

For really fast drivers a suitable value for R16 might be about 220 Ω.

The maximum speed at which measurement is still reliable then lies around 140 mph (but who is still interested in fuel consumption at that speed?).

Usually the value of 330 Ω as given in the diagram will give the best results for the ABM meter; if different flow sensors are available giving other frequencies per gallon, the value of R16 will have to be modified accordingly.*

Construction

The entire extension circuit — i.e. the circuit of figure 3 except the original (upper) part — is mounted on one p.c.b. Figure 5 shows the p.c. board, and figure 6 the component layout.

Although the supply voltage terminals of the original litres-per-hour meter can, of course, be simply connected to the battery as shown in the instructions, the point in question can also be connected to point 'B' of the extension board to improve interference suppression. The supply voltage for the entire circuit is best obtained from the 'accessories' position of the ignition lock.

The instruction leaflet supplied with the litres-per-hour meter gives sufficient information on how to install the flow sensor (X). The speed sensor (Y) can be attached to the speedometer by means of its rubber suction pad or, better still, with some suitable glue. The best position will be found by experiment; this will usually be close to the drive cable. This telephone coil must be connected to the points C and D on the p.c.b. by means of a two-core screened lead.

Once switch S1 is wired, the last remaining 'obstacle' is the connection to points A and A'. In practice this is not too difficult, as shown in figure 7. This is a photograph of the p.c.b. of the original litres-per-hour meter. At the place indicated by the arrow, the copper track forming the connection between the

*For instance, for the recently introduced 'Spacecom' digital flow sensor, giving 3200 pulses per gallon, R16 would probably have to be increased to 3k3. At the same time, C9 would have to be increased to about 10 μ. Note that we have not tried this!

5,6

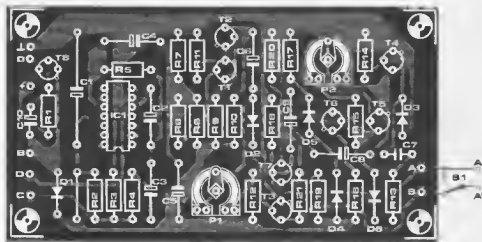
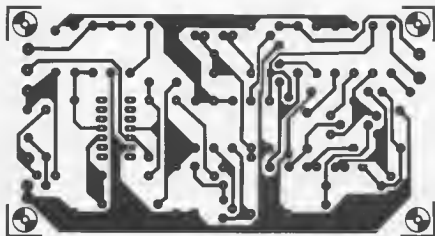

Figure 5. The p.c.b. layout for the extension circuit.

Figure 8. Component layout on the p.c.b. The supply of the original meter can be connected to point 'B'.

collector of transistor T_6 and the 39 k resistor must be interrupted. Two wires are (carefully!) soldered on, one on each side of the break, and connected to points A and A' on the extension p.c.b. Even the less experienced will probably have little difficulty building the relatively simple circuit on the p.c.b.

Final notes

Nobody will doubt that a fuel consumption meter is a useful instrument. It will persuade many to drive more 'economically', thus contributing towards the general drive to save energy. However, a word of warning is justified: *Under no condition should use of the fuel consumption meter be allowed to endanger road safety.* The driver's attention should in principle always be on the traffic, and only when traffic conditions allow will a quick glance at his instrument panel be justified. An instrument like this fuel consumption meter will be an extremely interesting eye-catcher, which involves the risk that it might 'steal the show' by drawing attention from more important matters.

Furthermore, drivers should be careful not to develop such an 'economic' style of driving that road safety is adversely affected. One might, for example, easily be startled by a sharp drop of the meter indication when accelerating to overtake other road users; however, seeing this brief higher fuel consumption should not lead the driver to take it easy and spend a dangerously long time in the wrong lane.

To conclude, a remark that should really not be necessary: *it is just asking for trouble if the same person combines driving the car and adjusting the fuel consumption meter.* This calls for the undivided attention of two people! ■

from stereo to SQ

B. Bauer

Recent developments in quadrasonic sound were very much in evidence both at the 53rd Meeting of the Audio Engineering Society, in Zürich, where CBS showed its latest SQ decoders and records, and at the Festival du Son, in Paris, where no less than 16 manufacturers of high-fidelity equipment displayed receivers and players embodying the SQ* system — by far the most popular quadrasonic system on the market today. Ideas were shared at the meetings with outstanding recording engineers and high-fidelity enthusiasts. One fact stood out with complete certainty: those who had experienced quadrasonic in their own homes were the quadrasonic who expressed total satisfaction and commitment and declared that they would never go back to stereo. Those who had not experienced quadrasonic were the quadrasonic who, nevertheless, were interested and willing to discuss their concerns with the quadrasonic. Some conclusions stemming from these interactions are reported here for the interest of those planning to experiment with quadrasonic.

It became evident during the course of the discussions that much of the existing quadrasonic folklore had made quadrasonic appear as a forbidding extravagance which obsoleted one's existing stereo investment. But the facts, of course, are otherwise. Quadrasonic — especially SQ quadrasonic — is a relatively simple but necessary step toward better fidelity of sound reproduction, which actually enhances the user's present high-fidelity equipment and records. And, furthermore, it is attainable at modest cost, well within the means of most hi-fi enthusiasts, especially those willing to construct some of their own equipment.

What they say

First, let's listen to the quadrasonic. Some complain about the cost of decoders and the expensive duplication of amplifiers and loudspeakers. Others are troubled by the problem of quadrasonic loudspeaker arrangements. ('My wife will never put up with them.') Others are worried about the fate of their stereo record collections. And a few are opposed to quadrasonic in principle, with the argument, 'I have only two ears — why should I listen to four sources?'

What came to mind in discussing these matters was the slow and patient process of education and demonstration that had been required during the introduction of stereo a decade and a half ago. We believe that history is bound to repeat itself with quadrasonic.

The two ear . . . four loudspeaker paradox

Let us dispose of the 'two-ear' argument first by pointing out that its logical conclusion would be to listen only to duets because each performer in a symphony orchestra is a separate source of sound. Nevertheless, there is a serious aspect to this otherwise fatuous argument since it gives us an opportunity to answer the question of why

quadrasonic — not stereo — provides true high fidelity and, in addition, why four, not three, loudspeakers are necessary for effective reproduction of the auditory space.

Consider a listener in a concert hall, depicted in figure 1. He first hears the direct sounds of the performers and soon they are followed by sounds reflected from the walls, floor, and ceiling. All these reflections build up into the spatial reverberant energy which gives the concert hall its characteristic ambience surrounding the listener. Let us assume that both the direct and reverberant sounds are picked up with four microphones shown in the illustration, and that the resulting signals are properly mixed so as to produce a stereo record which is reproduced over a stereo system, shown in figure 2. It is clear that regardless of how skillfully the direct and the reverberant sounds have been mixed for stereo, they emerge from stereo's two loudspeakers, which tends to confuse the direct sounds. But, if the orchestral sounds are reproduced over the front loudspeakers and the ambience sounds over the four loudspeakers, as shown in figure 3, then it is possible to closely approximate the sound field of the real concert hall. Conclusion: quadrasonic produces spatial high fidelity; stereo does not.

But why four loudspeakers? A facile answer is that four loudspeakers are used because rooms are square, not triangular; but there is a more fundamental reason which is to be found in the way human hearing responds to a sound field. Listen to the center solo of a stereo record over the two loudspeakers. As you approach the line connecting the two speakers, the center image rises, and on the center line it appears to be directly overhead! From this it follows that for a good periphonic capability we need four loudspeakers, because a rectangle in addition to connecting lines on the periphery also has connecting diagonals, therefore giving the listener an opportunity to be

* SQ is a trademark of CBS Inc.

Editorial note

In Elektor 8 (December 1975) we published a background article on CD-4 and a construction project for a CD-4 demodulator, both sent to us by JVC. At the time, we stated in an editorial note that we wished to give the proponents of the other three systems an equal opportunity.

CBS, in the person of Mr. B.B. Beaur (Vice President and General Manager of the CBS Technology Center), has responded by sending us two articles on SQ. As with the previous articles, we have decided to publish them in full.

Our own thoughts on the subject of quadrophony at the present moment are outlined in a separate article elsewhere in this issue.

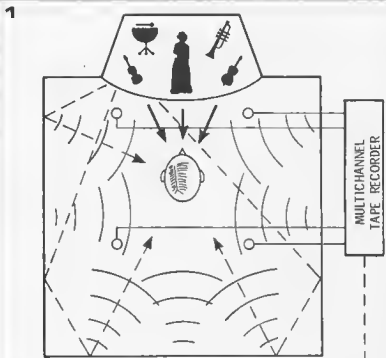
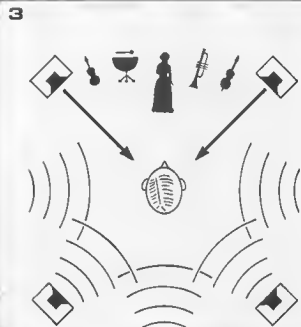

Figure 1. Stylized representation of a listener in a concert hall, and the production of a stereo program. The performers' sounds are shown in heavy arrows and the ambient sounds are shown by curved wavefronts.

Figure 2. Stereo's two loudspeakers cannot provide a true representation of a concert hall because the ambient sounds arrive from the same direction as the performer's sounds.

Figure 3. To properly reproduce the concert-hall experience four loudspeakers are needed, the front ones carrying the performer's sounds and the back ones cooperating with the front ones to reproduce the ambience.



sufficiently near a connecting line to hear elevated sounds, when they are present, anywhere within the listening area. The marvelous feeling of reverberation which rises to the top of the nave of the Freiburg Cathedral, in the E. Power Biggs recording of the Four Toccatas and Fugues of Bach, could not have readily been achieved with but three loudspeakers.

Quadraphonic loudspeaker arrangements

While, undeniably, space and cost permitting, identical loudspeakers are ideal for quadraphony, many quadrophiles have concluded that in practice it is not necessary for the back loudspeakers to be as large and costly as the front ones. This does not mean, of

course, that back loudspeakers of low quality are consistent with good quadraphony - but only that if the front loudspeakers have ample low frequency response then the back ones need not go quite as far 'down' as the front ones in the bass region. This is understandable because the nature of disc recording encourages the producer to place the heavy bass sounds near

center front, and, anyway, the direction of bass sounds is not readily perceived. Therefore, excellent but quite small loudspeakers responding, say, down to 60 Hz will be quite suitable for back channels while the front ones normally should provide full bass response. Small loudspeakers can be placed inobtrusively on lamp tables, bookshelves, or mantelpieces, eliminating much opposition which may arise from the mistress of the house to four large loudspeakers. Considerable experimentation since the early days of quadraphony has been going on with loudspeaker arrangements. Many experienced listeners have concluded that it is equally effective and often much more convenient to use the trapezoidal arrangement shown in figure 4 in place of a square array. Here, the back loudspeakers have been shifted 20-30° forward, in this manner producing an arc of sound in part surrounding the listener. The trapezoidal arrangement is especially convenient for a rectangular living room and it often is more pleasing than the square format to a listener venturing into quadraphony for the first time. The back loudspeakers can be placed conveniently at either side of the main seating area, preferably at the ear level of a standing person. In this manner several seated listeners can hear the back loudspeakers unimpeded and with relatively good sonic balance.

Ambiance vs surround sound

Some quadraphones say they wish to hear only frontal sounds — but we found this to be merely a stereo-induced habit. Once the historical context of surround sound is understood, opposition to it fades away. In the real world of music the composer and the conductor always have enjoyed the spatial freedom to surround the audience with sounds. We already have mentioned the Freiburg Cathedral (where an organist plays four spaced-apart organs simultaneously or antiphonally from a central console) — but other examples abound. In the 14th century, Gabrieli placed his choirs on four balconies of San Marco's in Venice. Berlioz staged his 'Requiem' in the Église des Invalides in Paris in surround sound using an enormous symphony orchestra and chorus augmented by four brass orchestras on the balconies and four pairs of kettledrums thundering from various placings. Stravinsky placed trumpets and tubas offstage in the 'Firebird' ballet. During the inaugural performance of his celebrated 'Mass', Bernstein surrounded the audience with four sources. Opera, musical comedy, and the rock group all offer great excitement in a surround-sound arrangement.

For too many years, alas, stereo's two-only loudspeakers have deprived the high-fidelity enthusiasts of hearing marvelous surround-sound performances with full spatial fidelity. Quadraphony breathes life into them. And the SQ record holds for the listener the best of the possible worlds — realistic ambiance

4

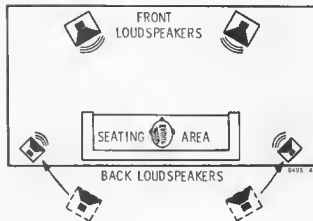

5



performance for the classical music lover, exciting surround sound for the more adventuresome hi-fi enthusiast, and standard stereo performance for the listener who has not, as yet, converted to quadraphony.

Because of SQ's excellent compatibility many records today are issued as 'stereo-compatible' with only a small note on the back of the jacket identifying them as being quadraphonic.

The SQ system revisited

The SQ system employs a special matrix to encode a stereo record or tape with four (or more) directional signals. Those signals which should appear over the front loudspeakers (and which normally include the front stage sounds) are applied to the SQ record in precisely the same manner as they are to a conventional stereo record. (This is the

Figure 4. Modified quadraphonic loudspeaker arrangement in which the back loudspeakers have been moved forward (as shown by curved arrows) to conform to the geometry of a rectangular living room. If the front loudspeakers have ample bass response, the back loudspeakers can be smaller units than the front pair.

Figure 5. Transformation of a stereo program to simulated quad after SQ synthesis.

Figure 6. Converting an existing stereo installation to a quadraphonic system by adding an SQ decoder, a stereo power amplifier, and two back loudspeakers.

reason why an SQ record or tape is so uniquely compatible with any stereo record system — the front channel sounds of SQ fill completely the space between the stereo loudspeakers just as any stereo record does.)

The back channels are contained in both the stereo channels in quadrature, in such a manner that the left-back channel signal leads in the left channel of the record and the right-back channel signal leads in the right channel of the record. In the stereo mode, these back-channel signals (which might represent reverberation in the ambience format or discrete sounds in the surround-sound format) are reproduced at full level at either side of the center and appear to be somewhat spread in space thus simulating a feeling of depth. And if the SQ record is reproduced in mono (as often happens when broadcast, since many receivers are monophonic), the listener hears all these sounds at appropriate levels, precisely as in the case of a stereo record. Because of these characteristics the SQ record can be considered a fully stereo- and mono-compatible record suitable for broadcasting as well as home use.

While the SQ record can be used in all existing mono or stereo equipment as any stereo record, its 'raison d'être', of course, is quadrasonic reproduction. For this purpose a suitable decoder is needed, as well as the additional amplifiers and loudspeakers. Although a simple matrix decoder will provide pleasing ambience decoding, the best SQ decoders are of the so-called 'logic' type. Elsewhere in this issue a construction project for a logic-type decoder is described.

SQ stereo record enhancement

There are currently available sizable catalogues of SQ records on some of the world's most respected labels. But, what about the existing stereo records? These can be played on SQ equipment in the normal manner, appearing mainly on front loudspeakers, with some of the random sounds spilling over to the back and resulting in a delightful synthetic ambience. Nevertheless, many radio broadcasters and listeners have wondered if their present stereo records can be endowed with a more pronounced quadrasonic perspective. Such a seemingly impossible feat of 'quadrasonic synthesis' turns out to be quite simple when an SQ encoder is at hand.

To synthesize quadro from stereo, the record is played in the normal manner, but its output signals are connected equally to the respective front and back channels of the SQ encoder. When this is done, the results are as follows: the monophonic listener hears no change whatsoever in the sound and the stereo listener perceives a slight change in channel separation; but the quadrasonic listener receives a pleasing surprise — the stereo orchestra is no longer located mainly in the front channels but is aurally 'bent' in an arc (figure 5) around the listening room.

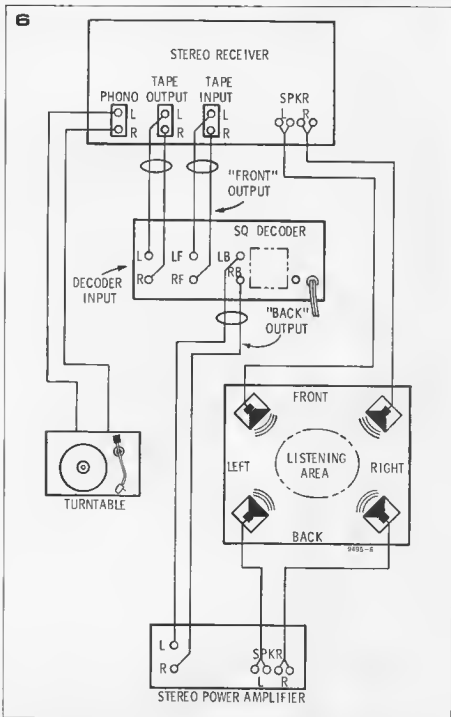

In effect, the listener is placed on the conductor's podium — a brand new concept in Spatial High Fidelity! And, this quadrasonic transformation does not, in any way, upset the sub-carrier/baseband level balance or the area coverage of the FM station, another unique advantage of the SQ system.

The above SQ synthesis or 'stereo enhance' circuit obviously can be provided either in the transmitter or the receiver. For the listener's convenience, it has been included (and made selectable at the turn of a knob) in the SQ decoder described in the companion construction project article. The listener will enjoy the new dimension which it provides to his existing records or stereo broadcasts.

Many FM stereo stations in the U.S.A. currently use one or more of the SQ broadcasting techniques: (1) direct

playing of SQ records or encoded tapes, (2) quadrasonic synthesis of stereo records or tapes using an SQ encoder, and (3) live broadcasting of local musical events using an SQ encoder. As a result of these resources, some stations have been able to announce that they are broadcasting fully compatible quadrasonic programs 24 hours a day.

How to convert to SQ quadrasonic in the home

The task of constructing an SQ decoder is made relatively simple through the use of IC's manufactured especially for this purpose by Motorola Inc. The Motorola SQ IC's are the MC1312 (matrix), MC1314 (control circuit), and MC1315 (logic circuit). A decoder using these IC's can be assembled by any skilled hi-fi enthusiast with reasonable ease. The circuitry shown in the

companion construction project is for an advanced full-logic decoder using what is known as a 'variable blend' circuit.

Once a decoder has been assembled according to the instructions, the existing stereo system is readily converted to quadraphony. Connect the decoder input terminals to the tape-recorder 'output' terminals of the receiver/preamplifier as shown in figure 6. Next, connect the 'front' output terminals of the decoder to the corresponding receiver 'tape input' terminals and switch the receiver mode switch to 'phono' and 'tape monitor'. This connects the two decoded front channels to the original stereo amplifiers and loudspeakers. The 'back' output channels are connected through an added stereo amplifier to the two loudspeakers at the back of the room. The turntable, pickup, and stylus remain unchanged from those used currently with stereo records.

After the equipment has been assembled in the specified manner, the four channels are balanced for pleasing listening. An SQT-1100 test record or any suitable SQ record such as 'Chase' ('Epic' EQ-30472), which begins with trumpets playing in succession around the room, will be found helpful for the achievement of acoustical balance between the front and the back loudspeakers.

Once a pleasing balance has been achieved the volume level is controlled with the decoder's volume control knob which adjusts the four channels simultaneously.

With the equipment arranged as in figure 6, the SQ broadcasts originating from any FM stereo station are reproduced quadraphonically, and any stereo programs are heard conventionally, with or without enhancement as may be desired. Therefore, many SQ listeners leave the equipment connected as in figure 6 for the reproduction of all their records and broadcast programs — stereo and quadraphonic.

Conclusion

The existing notion that quadraphony is a forbidding extravagance has been shown to be nothing but quadraphonic folklore. Quadraphony is a giant advance in the hi-fi arts because it brings with it Spatial Fidelity, or fidelity in space as well as in time. With an advanced SQ decoder built according to the companion construction project plus two amplifiers and two good but modest loudspeakers, any component stereo system can readily be converted to a high-performance quadraphonic system and its owner will discover a new level of enjoyment not only with new SQ records he might purchase but also with his present stereo records. This is why so many former quadraphobes have joined the ranks of the quadrophiles! ■

D. W. Gravereaux

SQL-200 SQ decoder

The SQL-200 is a 'free-standing' SQ decoder with its own power supply, intended for converting stereo receiver/preamplifiers to SQ quadraphony with the addition of another power amplifier and back loudspeakers. The unit is of full logic with variable-blend type. A stereo-to-quadraphonic enhancement mode as well as a stereo mode are also included.

The complete circuit is shown in figure 1. The two inputs (LT and RT) are at the left and the four outputs (LF, RF, RB and LB) are at the right of the diagram.

T1 and T2 are input amplifiers providing 8 dB of gain. Closing switch S2 reduces the gain of this stage to -6 dB for high level studio use, when the audio level is 1 volt.

IC1 (Motorola MC1312) is the SQ Matrix Decoder integrated circuit. The two networks connected to pins 1, 4 and 5, and 9, 10 and 13, are the phase-shift components. The phase shifters cover a frequency range of 200 Hz to 20 kHz with an accuracy of $\pm 7^\circ$. This is sufficient for a separation between the left-back and right-back channels of more than 26 dB over this frequency range.

T3 through T5 comprise the stereo enhancement circuit, which will be discussed later.

The four matrix outputs from IC1 (L'F, L'B, R'F and R'B) connect to the mode

switch, S1. S1 is a five-pole three-position switch to select 'SQ Quadraphonic', 'Stereo Enhancement', or 'Stereo' modes. When in the SQ quadraphonic mode, the four outputs of IC1 are applied to emitter followers, T7 through T10. These emitter followers provide isolation so that the following circuits do not influence the decoder's frequency response or levels.

Proceeding from the emitter followers, the four matrix-decoded audio signals drive both the Logic integrated circuits IC2 (MC1315) and the Voltage Controlled Amplifier IC3 (MC1314). The audio signals going to the Logic IC are equalized for optimum logic performance by three RC circuits (C27/28, R43; C33/34, R58; C35/36, R64).

The Logic IC, IC2, develops control signals corresponding to the dominant sounds contained either in the front or back corners of the quadraphonic program. These control signals, from pins 3 and 5, drive the VCA (Voltage Controlled Amplifier) IC3, causing the four amplifiers within this IC to vary in gain in order to increase the quadraphonic separation. When the dominant sounds are center-front or center-back, the Logic IC (IC2) develops center-front/center-back signals on pins 7 and 8, which are used to actuate the variable-blend FET, T11.

T13 through T15 comprise the driving circuit for the FET. T13 and T15 are a rectifying differential amplifier; T14 is an adjustable constant current source used to set the variable-blend operating point and gain; and T12 is a saturating amplifier used to 'switch' the FET (T11).

Upon command from the center-front/center-back logic, T11 blends the back channels, L'B and R'B, in order to cancel the CF (out-of-phase) sound from the rear channels.

Also connected to the VCA integrated circuit (IC3) are the three balance controls and the master volume. Note that only a single-section potentiometer is needed for each of these functions.

Four output amplifiers follow the VCA,

supplying added gain (9 dB) and low output impedance. These amplifiers may be omitted unless the decoder is required to drive studio lines or very long cables.

Stereo enhancer

Return now to transistors T3 through T6. This circuit makes up the stereo enhancer. T3 is an inverting adder; T4, T5 and T6 make up a subtracting circuit. These circuits rearrange the stereo signal into a quadrasonic format. The 'Left' stereo signal is changed to Lp', the 'Right' stereo signal is changed to Rp', the stereo center appears as center front in a quad. The Logic and variable-blend further increase the quadrasonic separation; just as in the SQ mode.

Stereo

For stereo operation the audio signals for the left and right channels are taken from the two front matrix outputs, Lp' and Rp', and applied to the VCA (IC3) inputs. The Logic IC (IC2) is made inactive by grounding the 'dimension' control, R68. The volume and balance controls are left operative, and decoder output appears only from the Lp' and Rp' terminals.

Power Supply

A fully regulated current-limited power supply is included in the SQL-200 design. If a split-primary power transformer is used as shown, operation is possible on either 90-125 volt or 180-250 volt AC-mains. A voltage regulator IC, IC6 (MC1723C) controls the base of a series-pass transistor, T16. R105 adjusts the DC output to 20 volts.

Construction

The printed circuit board (figure 2) has been designed for mounting standard electronic parts, as well as some specific components, such as the printed circuit switch and the power transformer. The p.c. board can, of course, be modified for different components. However, it is suggested that the general layout be maintained in order to avoid any unforeseen problems.

The layout of the power supply is fairly critical. The negative terminal of the 1000 μ F filter capacitor, C56, must connect physically as close as possible to the transformer center-tap. This assures that the 'charging-pulses' do not create a voltage drop along a ground lead, introducing hum into the audio. A small heat sink must be used with the series-pass transistor, T16.

The power transformer (2 x 20 volts, 125 mA) can be mounted on the decoder's case if desired, with its leads soldered directly to the p.c. board. If the transformer used is different from the one specified, it is important to verify that the secondary voltage is between 20 and 40 volts per section. (Remember to tie the capacitor, C56, negative lead to the point where the transformer center-tap connects.)

The power supply voltage should be

adjusted to 20 volts DC before plugging in the MC1312, MC1314 and MC1315 integrated circuits. This is extremely important because the maximum supply ratings on these integrated circuits is 24 volts DC!

SI is a 5-pole, 3-position, switch; preferably make-before-break. It should be mounted close to the p.c. board so that the leads are kept short. Care must be observed in keeping track of the 14 wires needed!

All five potentiometers (volume, three balance and dimension) operate on DC control signals. (There is no audio on them.) Therefore, the controls may be located at any reasonable distance from the decoder itself. A remote control center could be utilized provided cable can be obtained with a sufficient number of cores. Also, for the mechanically ingenious, a 'joy-stick' control could be devised for the three balance potentiometers. Bypass capacitors may be required near the MC1314 IC to bypass AC picked up on the control lines from stray fields if the lines are very long.

The four output amplifiers (two MC1458, dual operational amplifiers) may be omitted for the home decoder. In this case, just connect the output sides of C47, C48, C49 and C50 directly to the respective output jacks on the decoder case.

Variable-Blend Adjustment

R73 sets the point at which the FET, T11, blends the signals in Lp' and Rp' during a center-front sound source. Adjustment is quite simple. Apply audio (from either the preamplifier output or sine-wave oscillator) to one channel input of the decoder and drive the same signal, attenuated by a specific amount, to the other channel. Then rotate R73 until the gate of T11 drops close to

ground, turning on the FET and thus blending the back channels.

Specifically, connect a high impedance voltmeter ($\geq 10 \text{ M}\Omega$)¹ between the positive lead of C29 and supply common. Connect the appropriate resistive network shown in figure 3 to Lt and Rt. Drive a constant² music signal, or a 1 kHz sine-wave into the network. While the audio is applied, note that if R73 is rotated from one end to the other end, the voltage of C29 varies from around +18 down to almost 0 volts. This indicates the correct performance. Now, set the potentiometer so that C29's voltage just reaches the lowest value. You will find this setting to be very sensitive... this is because you are setting the threshold at which the FET switches (when T12 drops to near 0 volts) and the gain of T12 is very high.

Checkout

A complete functional check of the logic portion of the decoder can be performed with an SQ test record, the SQL-1100. Users' instructions are included with this record.

If the record is not available, performance can be verified quite well by using

¹ We fail to see why it is essential to use such a high impedance voltmeter for this adjustment. A universal meter with a sensitivity of $20 \text{ k}\Omega/\text{V}$, and used in the 25 V f.s.d. range, should be adequate. The only difference is that the '+18 V' mentioned further on will then be +9 V - Ed.

² It is best to use a loud busy music selection, such as a full chorus, fortissimo, or loud continuous rock music.



a single audio source, such as the output of the phono preamplifier or tuner, or a 1 kHz oscillator. To check the SQ mode for L_F , R_F and C_F logic operation, proceed as follows: First, turn the dimension control fully clockwise, center the balance controls, switch to SQ logic, and adjust the volume control for a reasonable level. Then apply the audio signal to L_T (0.25 volts from the oscillator, or high level 'busy' music from the phono preamplifier or tuner output). Observe that the output appears from L_F , no audio from R_F and that the sound is attenuated at the L_B and R_B outputs (approximately 15 dB below L_F).

Repeat for R_T and observe that L_F now has no output and that the back channels are similar to the previous L_T test. For a center-front signal, drive the same audio signal into both L_T and R_T ; observe equal outputs on L_F and R_F , and observe attenuated outputs on L_B and R_B (approximately 15 dB below L_F and R_F).

To check the back logic, switch the decoder to 'enhance'. Drive audio into L_T and observe that output signal appears on L_B , with very little output on all other channels (15 dB below L_B). Repeat for R_T and observe output on R_B , with low output on the other channels (approximately 15 dB below R_B). If both L_T and R_T are driven together with the same signals, L_F and R_F should have the same output, whereas the two backs should be attenuated (15 dB below either L_F or R_F).

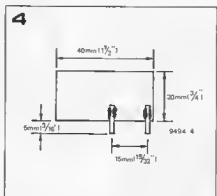
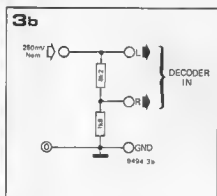
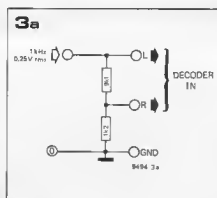

Operating Suggestions

The SQL-200 decoder is intended for operation at an input level of 250 millivolts (1.0 volt if switch S2 is closed). Operation with audio signals considerably below this value will yield poor separation. Similarly, operation above 250 millivolts average level could cause audio distortion. Fortunately, most equipment in the home operates around the EIA recommended standard of 250 millivolts.

Some suggestions on how to incorporate the decoder into the existing hifi system are given in the companion article 'From Stereo to SQ'.

Volume

If the decoder is used with a quadraphonic receiver, it is desirable to set the SQL-200 volume to an appropriate position and then make all listening level adjustments with the receiver master volume. A method of adjusting volume is to play an FM station directly. Then switch to the decoder ('Tape Monitor' on the receiver) and adjust the decoder volume for equal output level. When the decoder is used with a stereo

receiver, the volume control on the receiver should be used to adjust the program volume.

Channel Balance

Best SQ performance is obtained when the entire decoder, amplifier, and speaker are balanced for the preferred listening position or area.

An SQ test record, the SQT-1100, is available for setting SQ decoder balance. If this record is not on hand, the adjustment can be made using any SQ record which contains a solo vocal or lead instrument and instrumental music in all four channels. Before adjusting the balance controls, set all three to mid-position. Stand between the front loudspeakers to observe an apparent sound image of the solo directly in front of you. If the image is not centered, adjust the 'front balance' control to achieve the centered image. Next, while playing the same selection portion, stand between the two back speakers. Adjust the 'back balance' for equally loud instruments in both back speakers. Finally, adjust the 'F/B (front-back) balance' for the desired level of the two back speakers relative to the front pair.

In general, pop or rock type music is recorded in 'surround sound' wherein the accompanying instruments are placed around the listener in a balanced or interplaying orchestration. This type of music is helpful for checking the acoustical balance of the decoder. A record like 'Chase' (Epic No. EQ 30472) in which trumpets are played in successive channels around the room is excellent for this purpose.

Dimension Control

This knob adjusts the amount of logic enhancement for corner-channel sounds in both the 'SQ' and 'stereo enhance' modes. In conventional listening areas, such as a living room with light drapes and some overstuffed furniture, the 'dimension' control should be set about 3/4 clockwise. However, if there are many pieces of furniture, drapes, and carpet, then a lower setting of this control may provide a more pleasing quadraphonic performance.

References

- B. B. Bauer, R. G. Allen, G. A. Budelman, and D. W. Graveriaux, 'Quadraphonic Matrix Perspective - Advances in SQ Encoding and Decoding Technology', *J. Audio Eng. Soc.*, vol. 21, pp. 342-349 (June 1973).
- B. B. Bauer, G. A. Budelman, and D. W. Graveriaux, 'Recording Techniques for SQ Matrix Quadraphonic Discs', *J. Audio Eng. Soc.*, vol. 21, pp. 19-26 (Jan./Feb. 1973).
- B. B. Bauer, D. W. Graveriaux, and A. J. Gust, 'A Compatible Stereo-Quadraphonic (SQ) Record System', *J. Audio Eng. Soc.*, vol. 19, pp. 638-646 (Sept. 1971).

Figure 1. Complete circuit of the SQ logic Decoder.

Figure 2. Component layout and p.c. board for the decoder.

Figure 3A. Network for variable-blend adjustment when using a 1 kHz sine-wave. The outputs from this network are fed to the L_T and R_T inputs of the decoder.

Figure 3B. Network for variable-blend adjustment when using a music source.

Figure 4. This brass shield should be mounted on the p.c. board between the mains transformer and the output amplifiers.

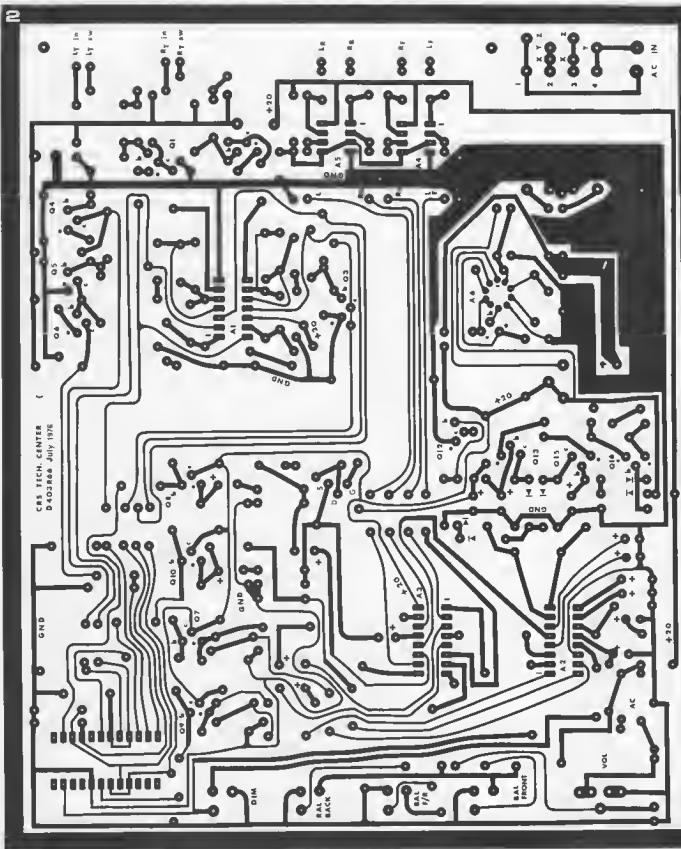

CBS TECH. CENTER
D403884 July 1976

Parts list

Resistors

R1,R11 — 47 k
R2,R12,R37,R38,R46,R53,R59,R60,
R100 — 1 M
R3,R13 — 22 k
R4,R16 — 16 k
R5,R17 — 330 k
R6,R18,R100,R101 — 10 k
R7,R8,R19,R20 — 3k9 (5%)
R9,R10,R14,R15 — 4k7 (5%)
R21,R31 — 01 k (5%)
R22,R30 — 150 k (5%)
R23,R26,R32 — 24 k (5%)
R24,R29 — 130 k (5%)
R25 — 2k2 (5%)

R26 — 100 k (5%)
R27 — 12 k (5%)
R33 — 20 k (5%)
R34 — 1k5 (5%)
R35 — 2k7
R36 — 22 k (5%)
R40,R48,R55,R62 — 4k3 (5%)
R41,R44,R56,R63 — 2k2
R42,R43,R57,R58,R64,R100 — 5k1 (5%)
R45,R52,R65 — 100 k
R49,R66,R77,R78 — 2 k (5%)
R50 — 300 Ω (5%)
R51 — 8k2 (5%)
R57 — 3k3
R69 — 470 k

R70,R83 — 1 k
R71 — 51 k (5%)
R72 — 220 Ω
R74 — 82 k
R75,R76,R79,R80 — 1 k (5%)
R81 — 2k7 (5%)
R82,R85,R103 — 2 k
R86 — 780 Ω
R90 — 30 Ω (5%)
R91 — 51 Ω
R92 — 4k3
R93,R96,R97,R102 — 120 k
R104 — 2122 Ω W (5%)
R107 — 3 k (5%)
R109 — 2k2

R110 — 100 Ω
R68 = 10 k lin potentiometer
R73 = 270 Ω preset
R84 = 5 k log potentiometer
R87,R88,R89 = 5 k lin potentiometer
R105 = 1 k preset

Capacitors

C1,C2,C16 — .25 — 220 n
C2,C8 — 47 n
C3,C6,C9,C14 — 18 n (5%)
C4,C13 — 100 n (5%)
C5,C10 — 3n3 (5%)
C11,C26,C30,C37,C58 — 4μ7/25 V

2

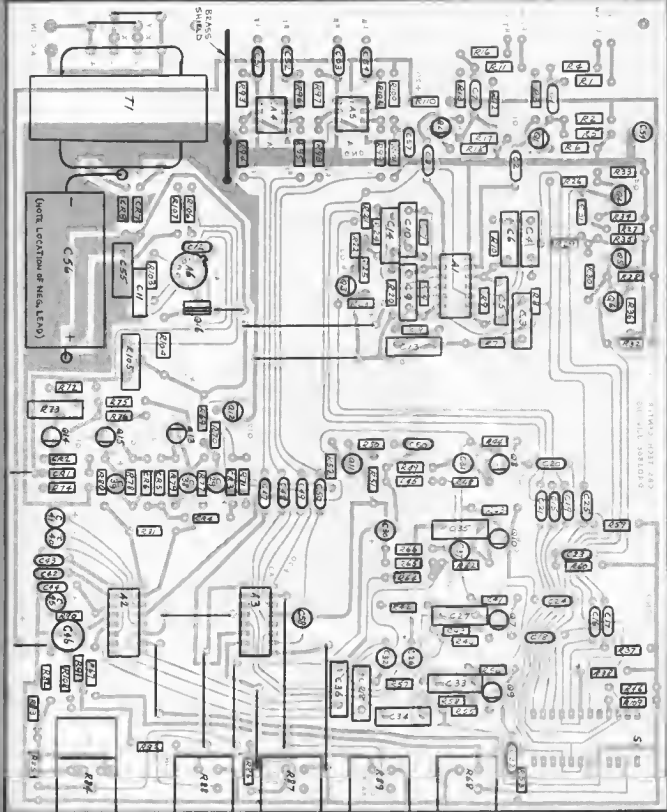

- C12 = 100 p
- C27 C33 C35 = 39 n (5%)
- C38 C34 C36 = 4n7 (5%)
- C39 = 2µ/25V (10% tolerance)
- C31 C37 = 16µ/25 V
- C36 C32 = 4µ/325 V
- C40 C41 C45 = 2µ/25 V
- C42 C43 C47 ... C54, C57, C59 = 1 µ
- Electrolytic
- C54 = 150 µ
- C46 = 20 ... 22 µ/25 V
- C35 = 10 n
- C36 = 1000 µ/35 V
- C38 = 47 µ/25 V

- Semiconductors**
- T1 T10, T12 - 2N3391, MPS6520, BC106
 - T11 - 7MS661
 - T13 - T15 - MPS455, BC179
 - T16 - DA401, MPSU05, BD139
 - IC1 - MC1312P
 - IC2 - MC1315P
 - IC3 - MC1314P
 - IC4, IC5 - MC1458CP, MC5558CP
 - IC6 - MC1723C, µA723C
 - D1 ... D6 = 1N914
 - D7, D8 = 1N4002
 - D9 = LED

- Supplies:**
- Main transformer, secondary 2 x 18 - 24 V, 125 mA.
 - Selector switch: 40 BT (total pole, 10-way), preferably make a before break.
 - Main fuse and fuseholder, if required, 250 mA fast blow for 220-245 V mains, 500 mA fast blow for 110-145 V mains

This p.c.b. layout was supplied to us by CBS. Note the unusual pinning of some of the transistors and potentiometers. Our circuit board design staff are presently working on a new board layout for the EPS service, which we hope to publish next month.

ignition timing stroboscope

There are several ways of adjusting the ignition timing of a car engine. One of the quickest and best is to use a stroboscope. The stroboscope timing aid described in this article is a self-contained unit for easy adjustment of the car's ignition.

It can also be used for running a fluorescent lamp off the car battery and with a few modifications it will operate as an electronic flasher for photographic use.

The equipment differs from most commercially available stroboscopes in that it has its own high tension power supply. There is no need to interfere with the car's existing high tension wiring, except for the link to the ignition system required for triggering the flash. The unit only draws an extremely small amount of energy from the power intended for the spark.

'Simplicity' was the catch word maintained during the design of the circuit. The critical component in the unit is formed by a transformer having a centre-tapped secondary (2 x 6 V) and a 220...245 V primary. For those who remember the 'good old days' of valves: a heater transformer.

The secondary winding is used in a balanced oscillator with T1, T2 as active elements. The transformer characteristics along with the resistors in the circuit determine the frequency the unit will oscillate at. In this case it will be about 100 Hz.

The transformer primary (which is used as the secondary in this unit) will supply about 325 V (AC) which results in approximately 450 V (DC) after rectification (off load). With an 8 mA load, the voltage drops to about 300 V. The DC voltage is used to power the strobe light. The current for the fluorescent lamp comes direct from the transformer winding.

A small readily available 8 W fluorescent lamp is used with this unit. This will slightly overload the circuit, causing saturation of the transformer core. This in turn leads to an increase of the oscillator frequency which improves the lighting efficiency of the fluorescent lamp. Admittedly, the lamp will not emit its normal amount of light, but it should prove to be a suitable and economical battery-powered camping light. There is little risk of the car battery running down in the course of the evening, since the current demand does not exceed 750 mA.

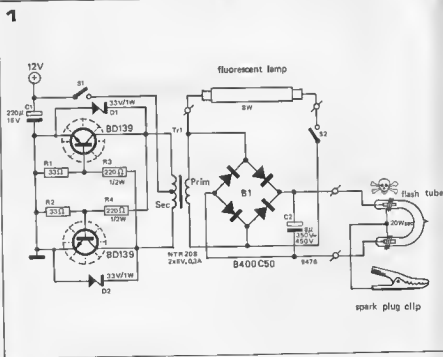

The unit can also be used as a photographer's electronic flash. However, several circuit changes will be necessary. Capacitor C2 must be increased to at least 250 μF (an electronic flash capacitor) and the trigger pulse must be applied via a pulse transformer actuated by the flash contacts on the camera.

Stroboscope

The diagram of figure 1 shows that only a small capacitor is connected across the flash tube when the device is used as a stroboscope. At a working voltage of 300 to 400 volts, the energy stored will be approximately 0.5 Ws. This energy is sufficient to produce a flash which is visible for about 50 cm (20 inches), depending of course on the ambient lighting conditions. On the other hand, the energy is not so high as to require a particular type of flash tube; any commercially available type capable of handling 20 Ws can be used. Since the ignition voltage of the flash tube is rather high it can be connected permanently across the capacitor without risk of spontaneous discharge. The tube must then be triggered in such a way that the flashes are synchronised to the ignition timing. It is standard practice to trigger a flash tube via a pulse transformer producing pulses of some 10 or 20 kV. However, since the pulses at the spark plug are already at this voltage, there is no need for such a transformer in this case. The trigger pulses can be derived straight from the spark plug electrode. This can be done by using a well insulated wire of sufficient length fitted with an adequately insulated alligator clip.

Using the unit

The timing reference is usually the firing of the spark plug in the number 1 cylinder.

As the flash is triggered at the instant the plug fires, the engine is illuminated at the same moment. The flash should make the rotating parts of the motor seem stationary. Somewhere on the engine there are special timing marks, usually one on the flywheel or a pulley on the crankshaft, and the other on the block.

When the unit has been correctly hooked up to the engine (plus and minus to the car battery and the trigger wire to the correct plug) these marks will both appear stationary. The timing adjustment is carried out by rotating the entire distributor housing until the marks are correctly aligned.

It is best to consult the car service manual or other service notes. They should contain the location of the timing marks and the correct alignment position of the marks. There may be other points to be noted, for instance, the vacuum advance and centrifugal advance may have to be disabled before timing can be carried out. A good motto is: 'If in doubt, don't'; contact your garage or the AA or RAC for further information'.

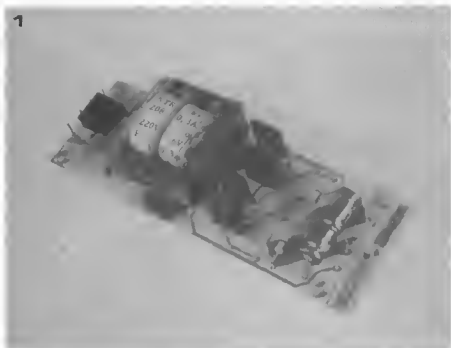

Photo 1. The unit can be quite compact. Bear in mind that good insulation is essential: the high voltages in the circuit can be lethal!

Photo 2. Prototype flasher unit. Nearly any flash tube can be used.

Figure 1. Complete circuit diagram.



Construction

The actual construction, although simple, must be carried out with care. All components except the flash tube and the fluorescent lamp are mounted on one printed circuit board, which should be mounted in an insulated case. Bear in mind that the voltage generated will rise to about 350 V and could become dangerous in the circumstances under which the equipment is being used!

It is a good idea to mount the flash tube in a separate shell (well insulated!) as it is rather awkward to 'aim' a box containing all the electronics... A reflector mounted in the shell will improve the brightness of the flash.

Photograph 2 shows the U-shaped flash tube fitted in its small case. It also shows how the triggering cable is arranged: the wire is wound around both ends of the flash tube. The high tension pulses from the spark plug ionise the gas inside the tube causing the gas to become conductive, initiating the flash. The prototype unit used a U-shaped flash tube, but practically any tube, whatever the shape and size, will be suitable.

Parts list:

Resistors:
R1, R4 = 33 Ω
R3, R4 = 220 Ω , 1/2 W

Capacitors:
C1 = 220 μ /16 V
C2 = 8 μ /350 V

Semiconductors:
T1, T2 = BD 139, 2N4923
D1, D2 = 33 V/1 W zener diode
B1 = bridge rectifier B400 C50

Miscellaneous:
Tr1 = 220...245 V prim. 2 x 6 V,
0.3 A sec.
S1, S2 = on/off switch.
Flash tube.

Figure 2. Component layout and printed circuit board for the complete circuit.

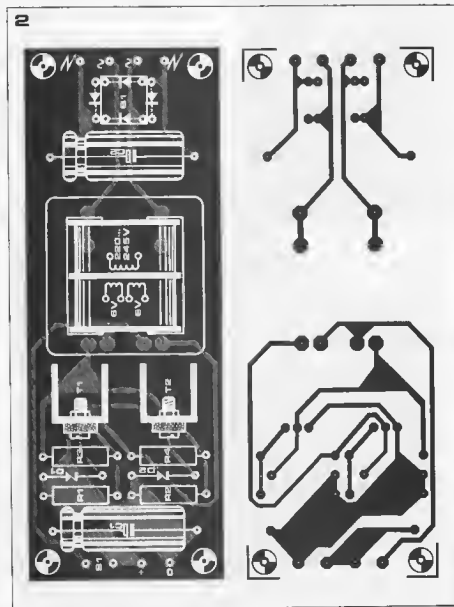

TV and audio circuits

TV tennis scoring
digits on TV
test pattern generator
pulse generator

COMING SOON



Domestic circuits
home burglar alarm
intercoms
and many others

TRANSISTORS

Type	PNP = P NPN = N	V _{CE0} (Volts)	I _{C0} (max) (mA)	P _{max} (mW) not cooled G = < 300 = 305-1000 cooled = 100 W = 10-35 W D _{max} = > 40 W	h _{FE} (min)	case nr.	comments
TUN	N	0	00	0	000		
TUJ	P	0	00	0	000		
AC126	P	0	00	00	0000	2	
AF239	P	0	0	0	0	1	grounded base f _T = 700 MHz
8C107	N	000	00	0	000	2	
8C180	N	000	00	0	000	2	
8C109	N	0	00	0	0000	2	low noise
8C140	N	000	0000	00*	00	2	
8C141	N	000	0000	00*	00	2	
8C180	P	000	0000	00*	00	2	
8C181	P	000	0000	00	00	2	
8C182	N	000	0000	0	0000	2	
8C212	P	000	000	0	000	2	
8C546	N	0000	00	00	0000	2	
8C556	P	0000	00	00	000	2	
8D186	N	00	00000	00**	00	7	
8D130	N	000	00000	00**	0	7	
8D132	P	000	00000	00**	00	9	
8D137	N	0000	0000	00*	00	9	
8D138	P	000	0000	00*	00	9	
8D139	N	0000	0000	00*	00	9	
8D140	P	0000	0000	00*	00	9	
8DY20	N	0000	00000	00**	0	7	
8F180	N	0	0	0	0	1	grounded base f _T = 675 MHz
8F185	N	0	0	0	0	12	grounded base f _T = 220 MHz
8F194	N	0	0	0	000	10	grounded emitter f _T = 260 MHz
8F195	N	0	0	0	000	10	grounded emitter f _T = 200 MHz
8F199	N	00	0	0	000	11	grounded emitter f _T = 550 MHz
8F200	N	0	0	0	0	1	grounded base f _T = 240 MHz
8F254	N	0000	0	0	0000	11	grounded emitter f _T = 260 MHz
8F257	P	00000	00	00	00	2	grounded emitter f _T = 90 MHz
8F494	N	0	0	0	0000	6	f _T = 260 MHz
8FX54	N	0000	00000	00	00	1	f _T = 70 MHz
8FX89	N	0	0	0	0	2	grounded emitter, f _T = 1000 MHz
8FY80	N	0	0	0	0	1	grounded emitter, f _T = 1000 MHz
8SX19	N	0	0000	0	0000	2	
8SX20	N	0	0000	0	0000	2	
8SX61	N	0000	0000	00	0000	2	
HEP51	P	00	0000	00	0000	1	f _T = 150 MHz
HEP53	N	00	0000	00	0000	1	f _T = 200 MHz
HEP56	N	0	00	00	0000	5	f _T = 750 MHz
MJE171	P	000	00000	00**	00	9	
MJE180	N	000	00000	00**	00	9	
MJE181	N	000	00000	00**	00	9	
MJE340	N	00000	00000	00**	00	9	
MPS A06	N	000	0000	00	00	13	
MPS A08	N	0000	0000	00	00	13	
MPS A09	N	00000	0	00	0000	13	
MPS A10	N	00	00	00	00	13	
MPS A13	N	00	000	00	0000	13	
MPS A15	N	00	00	00	0000	13	
MPS A17	N	00	00	00	0000	13	
MPS A18	N	000	000	00	0000	13	
MPS A55	P	000	0000	0	00	13	
MPS A56	P	0000	0000	0	00	13	
MPS UC1	N	00	00000	00*	00	14	
MPS U05	N	00	00000	00*	00	14	
MPS U58	P	0000	00000	00*	00	14	
MPS Z926	N	0	0	0	0000	13	f _T = 300 MHz
MPS3384	N	00	00	00	0000	13	
MPS3702	P	00	000	00	0000	13	f _T = 100 MHz
MPS3706	N	0	0000	00	0000	13	
MPS6514	N	00	00	0	0000	13	f _T = 480 MHz
TIP29	N	00	0000	00**	0	3	
TIP30	P	00	0000	00**	0	3	
TIP31	N	00	00000	00**	0	3	
TIP32	P	00	00000	00**	0	3	
TIP140	N	000	00000	00**	0000	7	Darlington
TIP142	N	00000	00000	00**	0000	7	Darlington
TIP2955	P	000	00000	00**	0	3	
TIP3055	N	000	00000	00**	0	3	
TIP5630	P	000	00000	00**	0	3	
2N686	N	000	0000	00	0	2	
2N700	N	0	0	0	0	2	
2N914	N	000	0000	00	0000	2	
2N1813	N	000	0000	00	0000	2	
2N1711	N	000	0000	00	0000	2	
2N1983	N	00	0000	00	0000	2	
2N1984	N	00	0000	00	0000	2	
2N2219	N	00	0000	00	00	2	
2N2222	N	00	0000	00	00	2	
2N2926	N	00	00	0	0000	13	
2N2955	P	00	00	0	0	2	
2N3054	N	000	00000	00**	00	7	
2N3055	N	000	00000	00**	0	7	
2N3553	N	00	0000	00*	0	2	
2N3568	N	000	0000	0	000	13	f _T = 500 MHz
2N3520	P	000	0000	0	000	13	
2N3702	P	00	0000	0	000	13	
2N3866	N	00	000	00*	0	2	f _T = 700 MHz
2N3904	N	00	000	0	00	13	
2N3905	P	00	000	00	000	13	
2N3906	P	00	000	00	000	13	
2N3907	N	0000	0	0	000	13	
2N4123	N	00	000	0	00	13	
2N4124	N	00	000	0	000	13	
2N4126	P	00	000	0	000	13	
2N4401	N	00	0000	0000	00	13	
2N4410	N	0000	000	00	000	13	
2N4427	N	0	000	00*	0	2	f _T = 700 MHz
2N5183	N	0	0000	00	000	2	

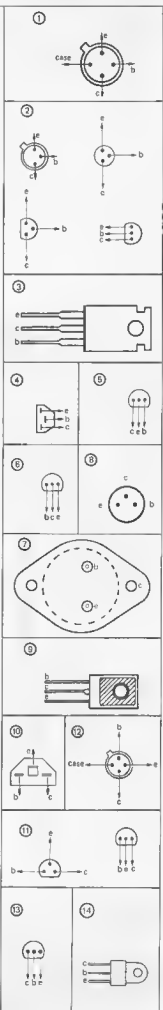

and many others

TUP TUN DUG

TUP TUN DUG

Wherever possible in Elektor circuits, transistors and diodes are simply marked 'TUP' (Transistor, Universal PNP), 'TUN' (Transistor, Universal NPN), 'DUG' (Diode, Universal Germanium) or 'DUS' (Diode, Universal Silicon). This indicates that a large group of similar devices can be used, provided they meet the minimum specifications listed in tables 1a and 1b. For further information, see the article 'TUP-TUN-DUG-DUS' in Elektor 1, p. 9.

	type	V_{ce0} max	I_c max	h_{fe} min.	P_{tot} max	f_T min.
TUN	NPN	20 V	100 mA	100	100 mW	100 MHz
TUP	PNP	20 V	100 mA	100	100 mW	100 MHz

Table 1a. Minimum specifications for TUP and TUN.

Table 1b. Minimum specifications for DUS and DUG.

	type	V_R max	I_F max	I_R max	P_{tot} max	C_D max
DUS	Si	25 V	100 mA	1 μ A	250 mW	5 pF
DUG	Ge	20 V	35 mA	100 μ A	250 mW	10 pF

Table 2. Various transistor types that meet the TUN specifications.

TUN		
BC 107	BC 208	BC 384
BC 108	BC 209	BC 407
BC 109	BC 237	BC 408
BC 147	BC 238	BC 409
BC 148	BC 239	BC 413
BC 149	BC 317	BC 414
BC 171	BC 318	BC 547
BC 172	BC 319	BC 548
BC 173	BC 347	BC 549
BC 182	BC 348	BC 582
BC 183	BC 349	BC 583
BC 184	BC 382	BC 584
BC 207	BC 383	

Table 4. Various diodes that meet the DUS or DUG specifications.

DUS		DUG
BA 127	BA 31B	OA 85
BA 217	BAX 13	OA 91
BA 218	BAY 61	OA 95
BA 221	1N914	AA 116
BA 222	1N4148	
BA 317		

Table 5. Minimum specifications for the BC107, -108, -109 and BC177, -178, -179 families (according to the Pro-Electron standard). Note that the BC179 does not necessarily meet the TUP specification ($I_{c,max} = 50$ mA).

	NPN	PNP
	BC 107 BC 108 BC 109	BC 177 BC 178 BC 179
V_{ce0} max	45 V 20 V 20 V	45 V 25 V 20 V
V_{eb0} max	6 V 5 V 5 V	5 V 5 V 5 V
I_c max	100 mA 100 mA 100 mA	100 mA 100 mA 50 mA
P_{tot} max	300 mW 300 mW 300 mW	300 mW 300 mW 300 mW
f_T min.	150 MHz 150 MHz 150 MHz	130 MHz 130 MHz 130 MHz
F max	10 dB 10 dB 4 dB	10 dB 10 dB 4 dB

The letters after the type number denote the current gain:

- A: α' (β , h_{fe}) = 125-260
 B: α' = 240-500
 C: α' = 450-900.

Table 6. Various equivalents for the BC107, -108, ... families. The data are those given by the Pro-Electron standard; individual manufacturers will sometimes give better specifications for their own products.

NPN	PNP	Case	Remarks
BC 107 BC 108 BC 109	BC 177 BC 178 BC 179		
BC 147 BC 148 BC 149	BC 157 BC 158 BC 159		$P_{max} = 250$ mW
BC 207 BC 208 BC 209	BC 204 BC 205 BC 206		
BC 237 BC 238 BC 239	BC 307 BC 308 BC 309		
BC 317 BC 318 BC 319	BC 320 BC 321 BC 322		$I_{c,max} = 150$ mA
BC 347 BC 348 BC 349	BC 350 BC 351 BC 352		
BC 407 BC 408 BC 409	BC 417 BC 418 BC 419		$P_{max} = 250$ mW
BC 547 BC 548 BC 549	BC 557 BC 558 BC 559		$P_{max} = 500$ mW
BC 167 BC 168 BC 169	BC 257 BC 258 BC 259		169/259 $I_{c,max} = 50$ mA
BC 171 BC 172 BC 173	BC 251 BC 252 BC 253		251 ... 253 low noise
BC 182 BC 183 BC 184	BC 212 BC 213 BC 214		$I_{c,max} = 200$ mA
BC 582 BC 583 BC 584	BC 512 BC 513 BC 514		$I_{c,max} = 200$ mA
BC 414 BC 414 BC 414	BC 416 BC 416 BC 416		low noise
BC 413 BC 413	BC 415 BC 415		low noise
BC 382 BC 383 BC 384			
BC 437 BC 438 BC 439			$P_{max} = 220$ mW
BC 467 BC 468 BC 469			$P_{max} = 220$ mW
	BC 261 BC 262 BC 263		low noise

TUP TUN DUG DUS

OPAMPS, COMPARATORS

703

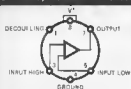

709

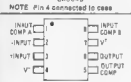

NOTE: Pin 7 connected to bottom of package.

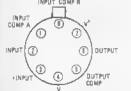

NOTE: Pin 4 connected to case

741 (N715, 9441)

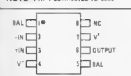

744 (N718, 9441)

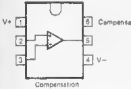
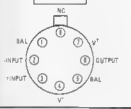

LM 2000

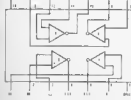

1458 (5558R)

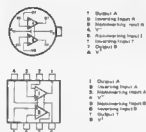

SN 76131 = TBA 231 = LA 739

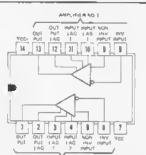

324

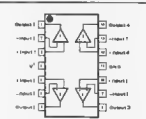

CA 3080

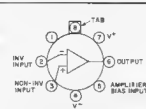

NOTE: Pin 4 is connected to case.

CA 3094

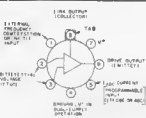

NOTE: Pin 4 is connected to case.

CA 3130

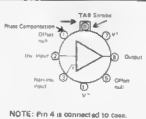

NOTE: Pin 4 is connected to case.

339 (330Z)

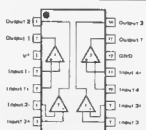

SPECIAL TYPES

CA 3086 = CA 3046



BOTTOM VIEW

556

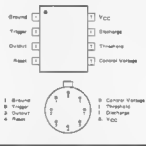

556



1310



VOLTAGE REGULATORS

L 129/L 130/L 131

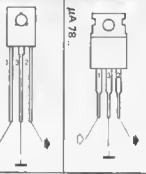

TBA 626 (829, 830)

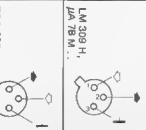

LM 200K

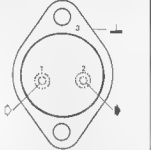

723 (550)

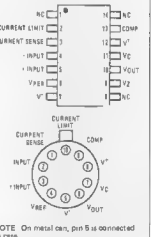

SG 3501 (SG 4501)

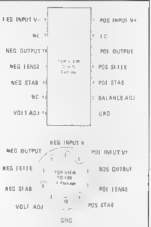

LM 325 (LM 125/LM 225)

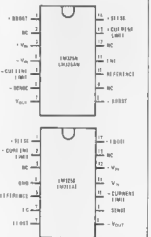

LM 209 H, LM 209 M

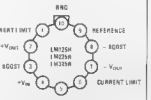

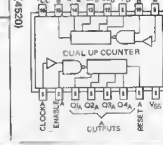
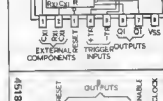
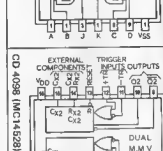
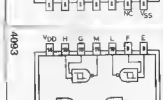
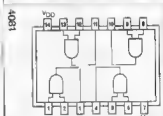
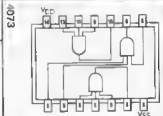
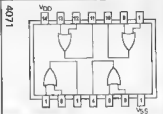
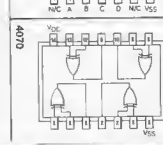
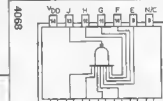
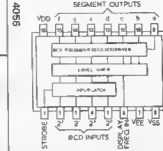
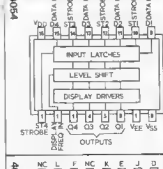
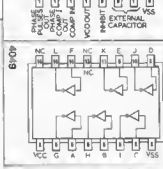
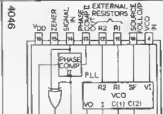
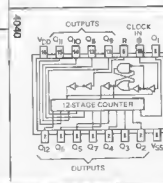
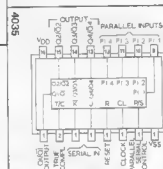
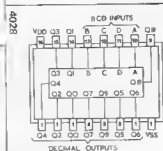
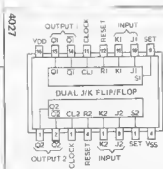
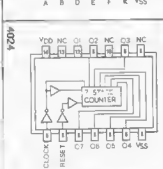
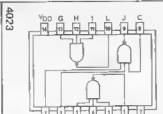
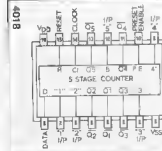
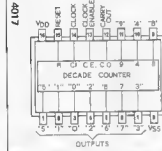
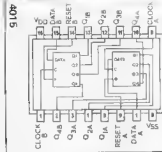
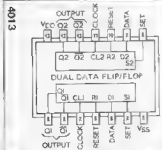
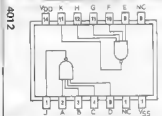
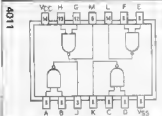
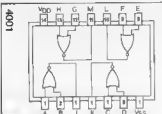

Note: A prefix to the type number denotes the manufacturer, e.g. CD 4001 (RCA), MC 14001 (Motorola), N 4001 (Signetics), SCL 4001 (Solid State Scientific), SIL 4001 (Silek).

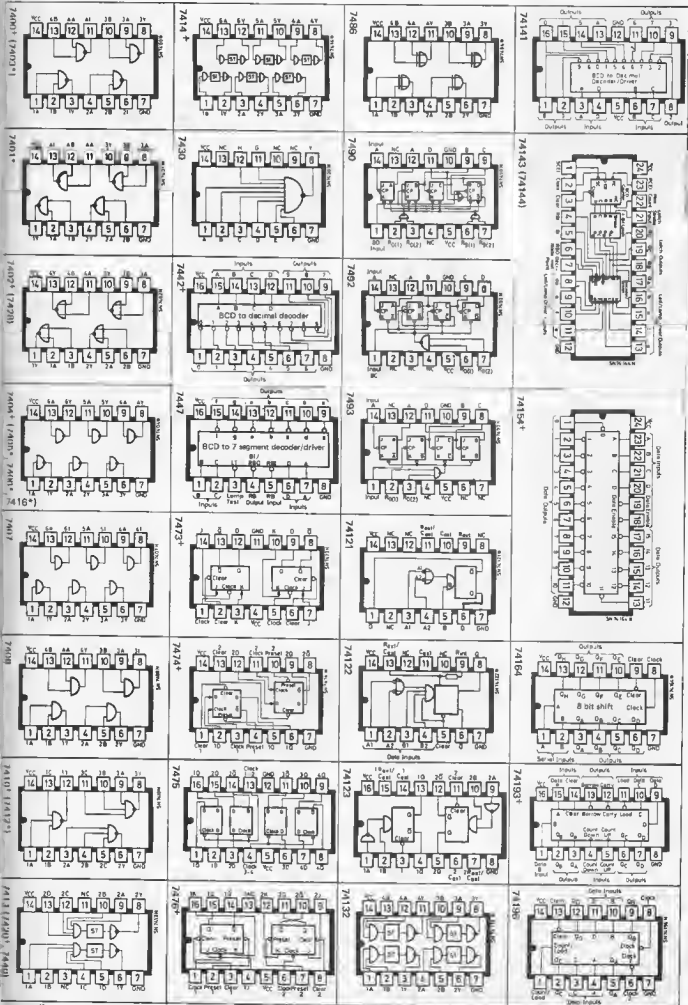

open collector

† Pin-compatible CMOS equivalents available from Teledyne Semiconductor and Diener Semiconductor

WHO and WHERE

A directory of electronic component suppliers to Elektor readers

IF THERE IS A COMPONENTSHOP IN YOUR AREA NOT LISTED BELOW PLEASE LET US KNOW

AVON

THE RADIO SHOP

Importers of Electronic Component Suppliers

16 Cherry Lane,
Bristol, BS1 3NG,
Tel. Bristol 421196,
S.T.D. Code 0272

CAMBRIDGE

B. BAMBER ELECTRONICS

5 Station Road,
Littleport, Cambs., CB6 1QE,
Tel. ELY (0353) 860185

DORSET

ELECTRONICS MART

370 Charminster Road,
Bournemouth, BH9 9RX,
Tel. Bournemouth 516565

ESSEX

ambit INTERNATIONAL

25 High Street,
Brentwood, Essex,
Tel. (0277) 216029,
Telex 995194

BI-PRE-PAK LTD

SOLE AGENTS FOR DISTRIBUTORS

222-224 West Road,
Westcliff-on-Sea,
Essex SS0 9DE,
Tel. Southend-on-Sea 46344

HARRINGTON COLORVISION

9 Quasn Street,
Colchester, Essex,
Tel. Colchester 47503

HANTS

Phoenix Electronics
Solent Limited

46 Osborne Road,
Southsea, Portsmouth, Hants.,

IRELAND

WM. B. FEAT & COMPANY LTD.

25/26 Parnel Street,
Dublin 1, Ireland,
Tel. 749973/4

KENT

Candis Limited
ELECTRONIC COMPONENT DISTRIBUTORS

P.O. Box 25 Canterbury,
Kent,
Tel. Canterbury (0227) 52139

Custom electronic controls

45, Picardy Road,
Belvedere, Kent, DA17 5QH,
Tel. Erith 34476

LEICESTERSHIRE

≡ Ely Electronics ≡

112 Groby Road,
Glenfield, Leicester,
Tel. Leicester 871522

LAS

ELECTRONIC SUPPLIES
3 Clivesway, Hinckley,
Leicestershire

Mays
of Church Gate

12/14 Church Gate,
Leicester, LE1 4AJ,
Tel. 58662

LONDON

CHROMASONIC electronics

56, Fortis Green Road,
London, N10 3HN,
Tel. 01-863 3705

DIRECT ELECTRONICS

Small quantities
AUDIO TELEVISION AND ELECTRICAL COMPONENTS
ELECTRICAL APPLIANCES AND TEST EQUIPMENT

627 Romford Road,
Manor Park,
London, E12 5AD,
Tel. 01-563 1174

Frank Mozer Ltd.

APPLIANCES IN ALL ELECTRONIC TELEVISION
AND AUDIO COMPONENTS RANGE

5 Angel Corner Parade,
Edmonton, London, N18,
Tel. 01-807 2784

GB GARLAND BROS. LTD
ELECTRONIC COMPONENTS SUPPLIERS

Chesham House,
Deptford Broadway,
London, SE8 4DN,
Tel. 01-692 4412

HENRY'S RADIO

303 Edgware Road,
London, W2

231 Tottenham Ct Road,
London, W1,
Tel. 01-636 6681

Smith's
EDGWARE ROAD

287-289 Edgware Road,
London, W2 1BE,
Tel. 01-723 5891

TECHNOMATIC LTD

54 Sandhurst Road,
London NW9



TRADING

1 St Michaels Terrace,
Wood Green,
London, N22 4S,
Tel. 01-889 7593

MIDLANDS

Chas. H. YOUNG LTD.

SUPPLIES OF COMMUNICATIONS EQUIPMENT

170-172 Corporation Street,
Birmingham, B4 6UD
Tel. 021-236 1635

(LTD) LTD

ELECTRONIC COMPONENTS

369 Alum Rock Road,
Birmingham, B8 3DR,
Tel. 021-327 2339

PHILCOM electronics Ltd.

Carnel Works,
Stockcough Lane,
Feniscowles,
Blackburn BB2 53R

NORTHANTS

HB

ELECTRONICS

54 Montagu Street,
Kettering Northants,
Tel. (0536) 83922

H. G. RAPKIN

22 Wellingborough Road,
Abington Square,
Northampton,
Tel. 37515

NOTTINGHAM

CHARLES TOWN

ELECTRIC COMPONENTS & DEALERS

69 Carrington Street,
Nottingham,
Tel. Nottm. 868933 and
55489

MTRs

20 White Hart Street,
Mansfield, Notts.,
Tel. Mansfield 23107

R.S.M. TELEVISION

38 Carrington Street,
Nottingham,
Tel. Nottm. 868933

OXFORD

SINTEL

53(K) Aston Street,
Oxford,
Tel. 0865 49791

SHROPSHIRE

CAMPBELL
ELECTRONICS Limited

Tweedele Industrial Estate,
Telford, Selop, TF7 4JR,
Tel. Telford (STD 0952)
585799,
Telegrams: CAMELEC

STAFFORDSHIRE

MATRONICS LTD.

63A Main Street,
Snarestone, Burton-on-Trent,
Staffs.,
Tel. Maasham 70255,
S.T.O. Code 0530

SURREY

BASIC electronics Ltd.

18 Epsom Road,
Crunford, Surrey

MAYDALE

ELECTRONIC SERVICES

2 Wellesley Parade,
Godstone Road, Whyteleafe,
Surrey CR3 0BL,
Tel. Upper Warlingham 5169

SUSSEX

AMTROP
UK

4-7 Castle Street,
Hastings, Sussex TN34 3DY,
Tel. Hastings 437875

YORKSHIRE

The Amateur Radio Shop

13, Chapel Hill,
Huddersfield, Yorkshire,
Tel. 20774

BELL'S TELEVISION SERVICES

190, Kings Road,
Harrogate, Yorkshire,
Tel. (0423) 55885

M & B COMPONENTS LTD.

86 Bishop Gate Street,
Leeds 1, LS1 4BS,
Tel. 0532 35649

The easy way to a PCB...

...the Seno 33 system!



The Dalo Pen!
The original fine-line etch resist marker. Simply draw the planned tracks onto the copper-clad board — new Quick-Dri inks ready for etching in minutes. Valve controlled ink dispensing for longer life. £1.50 for 1, £5.00 for 6, £9.40 for 12.

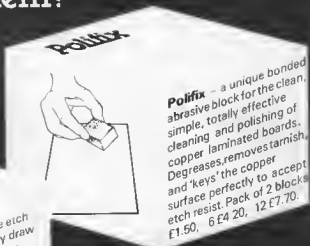

Polifix — a unique bonded abrasive block for the clean, simple, totally effective cleaning and polishing of copper laminated boards. Degreases, removes tarnish, and "keys" the copper surface perfectly to accept etch resist. Pack of 2 blocks. £1.50, 6 £4.20, 12 £7.70.



Seno etch resist transfer symbols for a truly professional finish!
Sharply defined, adhesive-backed symbols in easy-to-use strip form, adhere direct to copper laminate and offer total etch resistance. Presented in packs of 10 strips, each of different symbol. £2.00 per pack, £17.50 per 10 packs.



A revolutionary solution to the problems of etching PCBs! Unique sealed system minimises the risk, inconvenience, storage and disposal problems associated with the use of acid etchants — a complete kit designed to etch up to eight boards rapidly, visibly, effectively and SAFELY! £4.00 for a complete kit, £3.45 per kit in packs of 6.

Seno 33 — The Laboratory in a box

From your usual component supplier or direct from:

DECON LABORATORIES LTD.
Ellen Street, Portslade,
Brighton BN4 1EQ
Telephone: (0273) 414371
Telex: IDACON BRIGHTON 87443