

up-to-date electronics for lab and leisure

ELEKTOR

3

Summe 87

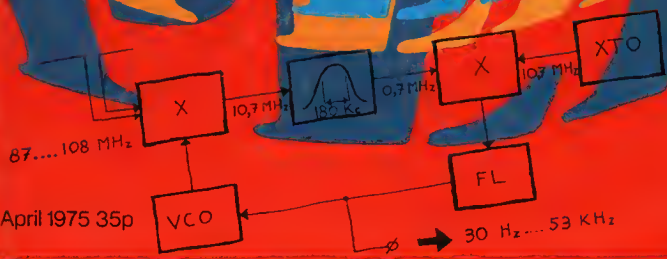

April 1975 35p

contents

selektor	409
Under this heading elektor will be publishing selected items about new technologies and developments.	
tap preamp (part 1)	410
Elektor readers will by now be familiar with the TAP or Touch Activated Programmer. For reliability and ease of operation all the preamplifier functions are controlled by TAP's and mechanical switches and potentiometers are eliminated.	
pll systems	412
It is the intention of this article to give an introduction to Phase-Locked-Loop (PLL) systems, without assuming any advanced mathematical knowledge on behalf of the reader, nor any familiarity with the subject.	
decimal to bcd converter - J. Wittje	417
fido	418
Fido is a new electronic game in which an unfortunate dog is called by four masters at the same time. If one of the players succeeds in getting Fido into his kennel, the game is decided: Fido stays where he is.	
elektor services to readers	422
time machine - H.U. Heinz	423
Slowly developing technological processes or natural events cannot be perceived because the eye is generally not able to distinguish the separate stages. Such events and processes can, however, be visualised by means of cinematographic time compression.	
marine diesel	427
noise generator - J. Jacobs	427
minidrum (part 2)	428
The Minidrum described in the previous issue may, by the addition of various extra circuits, be extended to a comprehensive manual drum kit. Some new instruments, a three channel ruffie system and an automatic bass-drum are described in this article.	
compressor	440
Compressors are now being used on an ever-increasing scale. They may be found in tape recorders, intercom systems and baby alarms, public address systems, discotheques and of course broadcast transmitters. A compressor supplements a manual volume control and allows a system to adjust itself to a wide range of input signals with little distortion. The design described here should find a wide range of applications with the electronics enthusiast.	
disc preamp	444
A preamplifier-equaliser for magnetic pickup cartridges has to meet quite exacting requirements. The well-known two-transistor configuration, operating from a 12 - 18 V supply, invariably falls short on gain and overdrive-margin - unless it is designed for a low nominal output voltage (about 30 mV). An alternative approach is to make use of a good integrated amplifier. The design described here, which meets all the requirements, employs a SN 76131. An almost identical I.C. is the μ A 739.	
a/d converter	448
The necessity to convert a voltage to a frequency such that the frequency is accurately proportional to the voltage is one which arises in many different electronic systems. Some digital voltmeters use this principle. The circuit described here is relatively simple, but nonetheless the absolute error is less than 1.5 mV and the relative error less than 1% over an input voltage range of 7 mV to 2.5 V.	
led displays	451
In response to numerous requests from readers we publish this LED-display chart to enable constructors to find their way through the jungle of seven-segment display data.	
modulation systems (part 2)	454
This instalment deals with Carrier Position Modulation (CPM), as well as with frequency and phase modulation. Frequency modulation has proved to be the best system for VHF broadcasting, while CPM is most suitable for speech transmission.	
the missing link	458
tup-tun-dug-dus	459
led-level - A. Deley	460
In general, analogue pointer instruments are used for level indicators. Another method of indicating amplitudes and power is to use LEO's.	
market	463
Under this heading elektor will be publishing brief descriptions of new products, based on the manufacturer's data.	

part 1

tap preamp

In a previous issue (elektor no. 2), in the article entitled 'Sonant', a new design of audio preamplifier and control unit was discussed, which would complement the power amplifier/loudspeaker combination of the Sonant. This article describes the design and construction of such a 'Pre-sonant', which combines high performance with simplicity of operation.

Elektor readers will by now be familiar with the TAP or Touch Activated Programmer. For reliability and ease of operation all the preamplifier functions are controlled by TAP's and mechanical switches and potentiometers are eliminated. This necessarily leads to some simplification of control functions, as such things as volume and tone control can now be implemented only in discrete steps. This is perhaps no bad thing, as the front panels of some modern amplifiers look like something from 'Star Trek' and one wonders if a training course is necessary to operate them. This design is, therefore, not suitable for the dedicated knob twiddler!

Assuming that the recording engineer has done his job properly, many control functions may be removed from the front panel of the preamp and may be replaced by internal presets. This applies to balance and tone controls, which may be adjusted to suit room acoustics and personal taste, after which no further adjustment should be necessary. The number of control functions was thus reduced to the following:

- Input Selection: Disc, Radio, Tape, Auxiliary.
 Volume: Four preset levels.
 Image Width: Four settings from mono to 'extreme stereo'.
 Tone: Bass lift, 'Presence', Flat, Treble cut.

It is hoped in a later article to include a touch station selector for radio. The layout of the touch panels is shown in figure 1. These are available from the Elektor Print Service.

Four Position TAP

All the controls mentioned above are based on the four-position TAP shown in figure 2, which is designed around an RCA COSMOS IC type CD4011AE, a quad two-input NAND gate. The circuit operates as follows:

When the circuit is first switched on the output of one of the gates will set to '1' and all the others are held at '0' since a '1' is applied to their inputs via the input

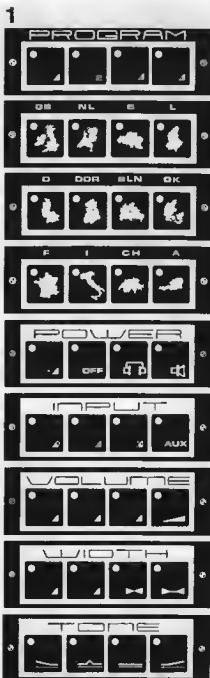

Figure 1. Touch panels for the TAP's. The contact surfaces and legends are nickel plated with a black background.

Figure 2. The circuit of the four-position TAP. Touching one of the input contacts causes the corresponding output to become '1' and all other outputs to become '0'.

Figure 3. Circuit to show the principle of an electronic 'make' contact. The LED indicates that the contact is 'closed'.

Figure 4. Extension of the circuit of figure 3 to control two channels.

Figure 5. The make contact applied to a four-preset-level volume control. The values of R_{15} - R_{22} determine the four preset volume levels.

Figure 6. The electronic 'break' contact. When a '1' appears at input Q_X T_1 and T_2 are cut off and the LED lights to show that the contact is 'open'.

resistors connected to $+V_B$ and via the diodes from the output of the gate whose output is '1'. Which output sets to '1' on initial switch on is determined by the switching speed of the individual gates and the various resistor tolerances.

Suppose now that input 1 is touched. Pin 1 of gate N_1 is now held at '0' by the skin resistance, the output therefore becomes '1'. This '1' is applied to the inputs of the other three gates via D_4 , D_7 and D_{10} respectively. Since the other input of each of these gates is already at '1' via the input resistors R_4 , R_8 , R_7 , R_9 , R_{10} and R_{11} the output of N_2 - N_4 becomes '0'. The logic level on the anodes of D_1 , D_2 and D_3 becomes '0' and pin 2 of N_1 is held at '0' by R_3 . Thus when input 1 is released the output of N_1 remains at '1'. This explanation applies for all the other inputs. Only one output can be a '1' at any time.

The TAP is used to control two types of electronic switch, a make contact, as shown in figure 3 and a break contact as shown in figure 6. When a '1' is applied to the Q_X input in figure 3, T_1 is turned on. Current flows through the LED and resistor into the base of T_2 , which is also turned on. The LED lights to indicate that this switch position is activated. The modifications necessary to switch two channels are shown in figure 4. T_1 is now used to switch two transistors and the base resistors are doubled in value (within the limits of preferred resistor values) to keep the LED current the same.

The Break Contact

The circuit of figure 6 operates in an inverse manner to that of figure 4. When the Q_X input is at '0' T_1 is turned off. However, T_2 and T_3 are turned on by current flowing into their bases via the LED, R_2 , R_3 and R_4 . The 'contact' is thus normally 'closed'. When a '1' is applied to the Q_X input T_1 is turned on thus grounding the bases of T_2 and T_3 and turning them off. Current flows through the LED via R_2 and T_1 so that it lights.

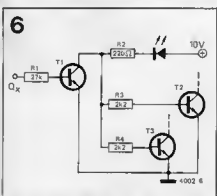
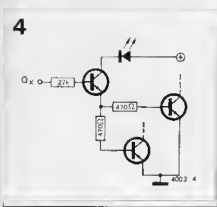
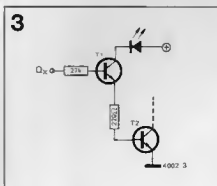
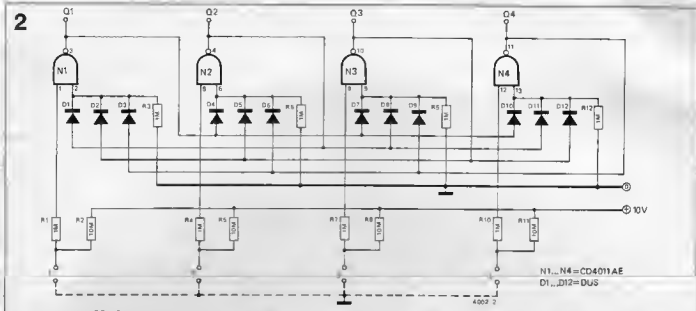

As an example of the use of the make contact a four-setting volume control is shown in figure 5. For the left channel R_{13} and R_{15} - R_{21} comprise a potentiometer, likewise R_{14} and R_{16} - R_{22} for the right channel. When one of the inputs

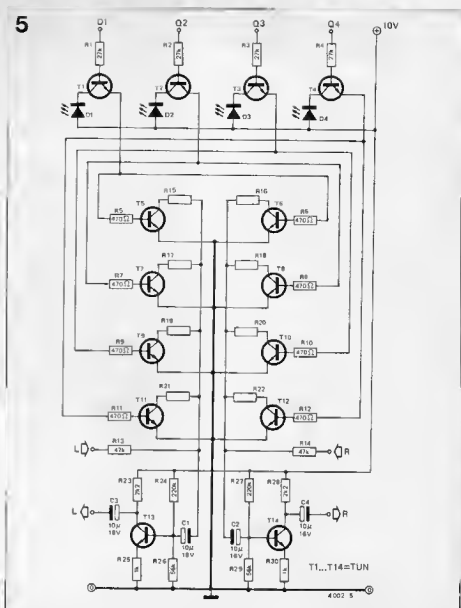

Q_1 - Q_4 is high then the corresponding transistors $T_5/T_{11}/T_{12}$ are turned on, grounding one end of the corresponding collector resistor R_{15}/R_{16} - R_{21}/R_{22} . The attenuation depends on the value of the resistor that is grounded and may be

varied to suit personal taste. After attenuation the signal is fed into the base of T_{13} (T_{14}) and the output is taken from the collector. This and the other control circuits will be discussed in greater detail in next month's article. ■

pll systems

The need for such an introduction stems from the ever-increasing use of PLL circuits in consumer electronics and from the increasing complexity of these circuits, which is threatening to make new developments in this field incomprehensible to many electronics enthusiasts. The article also deals with Feedback PLL systems, which are in many ways superior to conventional PLL circuits.

A simple receiver using the Feedback PLL principle will be described in a future issue.

A phase-locked-loop is a control system in which an electrical quantity is controlled by the phase difference between two signals. Figure 1 shows a block diagram of an arbitrary servo control system.

A_x and A_y are quantities of the same form such as A.C. or D.C. potentials. These quantities are compared with one another in block C by, for example, multiplication or subtraction. The result of the comparison is processed in block C in such a way that quantity A_y is adjusted. The form of processing determines a number of the control characteristics such as the control time constant. Quantity A_y is readjusted in such a way that a state of equilibrium is reached at the output of C.

Figure 2 is a block diagram of a PLL. In this case control is based on the phase difference between the input signal (1) and the signal (2) from a Voltage-Controlled Oscillator (VCO) so the contents of block ϕ must be able to recognize this difference.

The VCO is controlled in such a way that a specific phase difference is maintained between the output from the VCO and the input signal. The speed with which the PLL adjusts the VCO to follow any change in the input signal depends, in the first instance, on the characteristics of the low-pass filter LPF.

When two signals are multiplied together, the product includes a component that is proportional to their phase difference and that can be filtered out from the other components. Block ϕ performs this multiplication. In practical circuits the input signal is multiplied by a square-wave output from the VCO, which means in effect that alternate half cycles of the VCO square wave multiply the input signal by +1 and -1. The waveforms in figure 3 should make it easier to understand the mode of operation.

In figure 3a the input (represented as a sinusoid) is shown and below it a VCO square wave of the same frequency is repeated with phase relationships varying progressively from in-phase to 180° leading (figures 3b, 3d, 3f, 3h and 3j). During

the positive half-cycles of the VCO square wave (in any particular phase) the associated 'product' waveform (figures 3c, 3e, 3g, 3i and 3k) is the same as the input sine wave of 3a. During the negative half-cycles of the square wave the sine wave of 3a is polarity-changed in the product waveform. This is equivalent to multiplying the two waveforms together.

In the first product waveform (3c), which is associated with the in-phase square wave 3b, it will be seen that the product never becomes negative, in fact it is a full-wave rectified version of the sine wave. Its filtered D.C. value is thus unmistakably positive. When the square wave is leading by 45° , as in 3d, the product 3e clearly has a greater area above the line than below. Its mean D.C. level is therefore also positive, but less than 3c. When the square wave leads by 90° , as in 3f, the product 3g has equal areas above and below the line, so its D.C. value is zero. With leads greater than 90° the D.C. value of the product becomes negative, reaching a maximum (negative) value at $+180^\circ$ (3h to 3k). Summarising; the D.C. value of the product waveform varies from a maximum positive value when the square wave is in phase with the input signal, through zero when the square wave leads by 90° , to a maximum negative value when the square wave leads by 180° .

Assume now that the input and VCO frequencies are precisely equal and that the PLL is locked in (ignoring, for the moment, how it got that way). The

It is the intention of this article to give an introduction to Phase-Locked-Loop (PLL) systems, without assuming any advanced mathematical knowledge on behalf of the reader, nor any familiarity with the subject.

VCO square wave will be leading the input signal by 90° and the D.C. output of the phase comparator (multiplier) will be zero. Suppose now that the VCO frequency tends to increase. The phase lead will become greater than 90° and the D.C. output of the phase comparator will become negative. This will tend to reduce the VCO frequency and lock will be maintained with a slight increase in the phase lead. Conversely, if the VCO frequency tends to decrease, the output of the phase comparator will become positive, which will tend to increase the VCO frequency.

It can be shown that the input signal can also lock to harmonics of the VCO frequency, or the VCO to harmonics of the input signal (if the input signal is not sinusoidal as previously assumed). It is also possible to insert a frequency divider between the VCO and the phase comparator and by a combination of frequency divider and harmonic locking the ratio of VCO frequency to input frequency can be made to assume peculiar values such as $16/3$ for example. This opens up intriguing possibilities for frequency synthesis.

The capture process

Until now it has been assumed that the PLL is locked in. It is now necessary to consider what happens when the circuit is switched on and the VCO is out of lock, as it almost certainly will be. The short answer is that the VCO hunts until it finds a frequency and phase to which it can lock.

Some understanding of the capture process, as it is called, may fortunately be acquired without mathematics if the behaviour of the circuit is examined at certain points in the loop and certain assumptions are made.

To assist in the explanation, assume first that the connection between the PLL output and the VCO input is broken. The VCO, deprived of a control voltage, will take up its free-running frequency which may be assumed to be lower than the input frequency. It has already been assumed, when discussing the locked

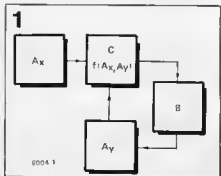

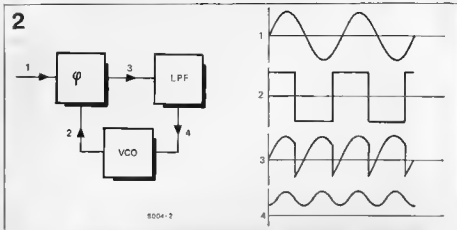
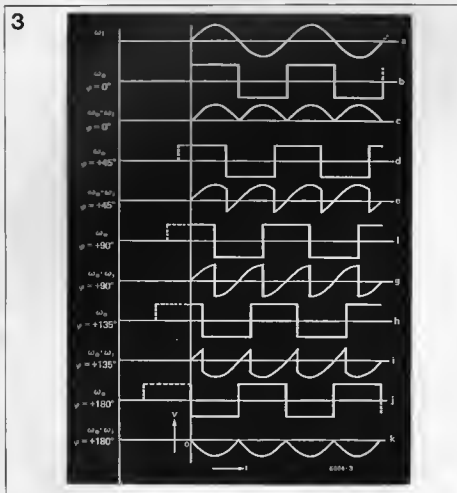

Figure 1. A control system consists of an information source Ax, a comparator circuit C, a processing circuit B and a controllable quantity Ay.

Figure 2. The elements of a PLL are: the phase comparator ϕ , the low-pass filter LPF, and the controllable oscillator VCO.

Figure 3. Showing how the output of the phase comparator varies with the phase difference between the input signal and the VCO.

Figure 4. Diagram to illustrate how the difference frequency waveform changes during one cycle of the capture transient.



condition, that the VCO frequency increases when the VCO control voltage goes positive and decreases when it goes negative. It may also be assumed that the LPF completely removes frequencies equal to the sum of the input and VCO frequencies, that it passes D.C. with no attenuation and that it passes the difference frequency of the VCO and input signal with some attenuation, which decreases as the difference frequency decreases (i.e. as the VCO frequency approaches the input frequency).

While the VCO is running free because of the supposed broken connection a difference-frequency oscillation of constant amplitude appears at the LPF output. When the connection is re-made what next happens must be examined carefully. As pull-in has not yet taken place a difference frequency still exists and an oscillatory voltage is fed to the VCO control input.

Consider now one positive swing of the VCO control voltage from trough to crest (figure 4). The VCO control voltage is going positive, therefore the VCO frequency is increasing and the difference frequency is decreasing. Because of the decreasing difference frequency the attenuation of the difference frequency signal in the LPF will be progressively reduced and the overall swing of the VCO control voltage will have greater amplitude than with the VCO free-running. Figure 4a compares the positive-going swings under controlled and free-running conditions, starting from the same trough potential and time. The crest of the controlled swing is more positive and it occurs later because the difference frequency is decreasing.

Figure 4b shows what happens during a negative (crest-to-trough) swing. Here the VCO control voltage is going negative and the VCO frequency is decreasing, so the difference frequency is increasing. Attenuation in the LPF is thus progressively increasing; overall amplitude is less than when free-running and the trough occurs sooner.

Figure 4b is added onto 4a to show what will happen during one complete trough-

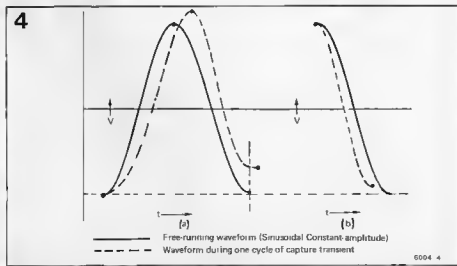

to-trough cycle of the difference signal. The positive-going half cycle has a more positive peak than the free-running difference signal. This 'handicaps' the negative-going half signal and its reduced amplitude also helps to make the trough more positive than it would be in the free-running condition.

Later cycles of the capture-transient, as it is called, cannot be compared with the free-running waveform, but they follow the same general pattern. Positive-going swings have increased amplitude while negative-going swings have reduced amplitude. This results in both crests and troughs becoming progressively more positive whilst the time interval between them becomes longer. This means that the VCO frequency will also increase until a point is reached where one of these swings of the control voltage sweeps the VCO frequency through the input frequency. More swings may occur until the VCO has found the correct phase relationship before lock-in actually occurs.

Applications of Phase Locked Loops

A PLL provides two information outputs. The VCO frequency, which is related to the input frequency, and the VCO control voltage whose value depends on the phase difference between the input signal and the VCO output.

If the desired information contained in the input signal is in the form of a frequency change (i.e. frequency modulation) then the PLL may be used as an FM detector. Its advantages over ratio detectors and coincidence detectors are: less distortion, better suppression of interference and the absence of LC circuits. PLL's are also useful in frequency synthesis as figure 5 shows. In the example given in figure 5a the condition for lock-in is that $f_c/nv = f_r$ and with a channel spacing of Δf we have $\Delta f = f_r$. The frequencies delivered by the VCO are thus multiples of the reference frequency and it follows that the VCO frequency is itself determined by the division ratio n . In many practical cases a variable-ratio divider will not be able to accept a high VCO frequency directly, so the VCO frequency is fed first to a stable fixed-ratio divider and from this to a stable adjustable divider. With this procedure it is possible to divide down from a relatively high carrier frequency to a low channel-spacing frequency. This is useful in, for example, aircraft VHF equipment.

In figure 5b an arrangement for frequency synthesis is shown in which delta pulses (needle pulses) recurring at the reference frequency from a crystal oscillator are fed into the phase comparator together with the VCO signal. As delta pulses contain the odd and even harmonics of the fundamental frequency the PLL can lock onto any harmonic.

Construction of a PLL

a. The VCO

Requirements for the VCO depend, in the first instance, on the application of

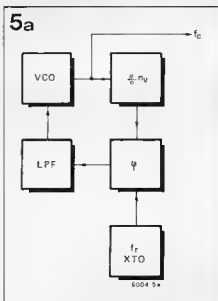

Figure 5a. By inserting a variable-ratio frequency divider between the VCO and the phase comparator it is possible to obtain various frequencies from the VCO using a single reference frequency f_r .

Figure 5b. With this system a large number of frequencies may be obtained by a simpler method than in figure 5a, though at the expense of stability which generally decreases as n increases.

Figure 6a. This VCO circuit has exceptionally good linearity and will work at frequencies up to 50 MHz.

Figure 6b. This VCO circuit consists of an LC oscillator tuned end/or controlled by a varicap diode. If the oscillator is also used for tuning a receiver (i.e. as the local oscillator) it is known as a tunable voltage-controlled oscillator (TVCO).

Figure 7. Simplified circuit of a VCO used in PLL IC's such as the Signetics NE565.

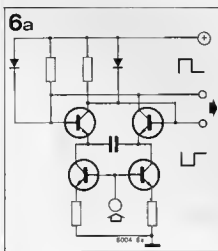
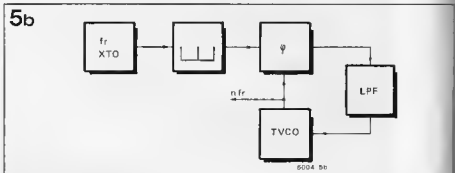
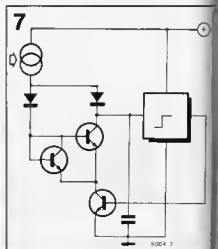
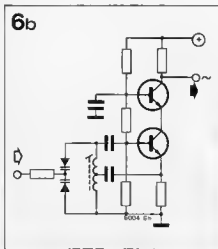
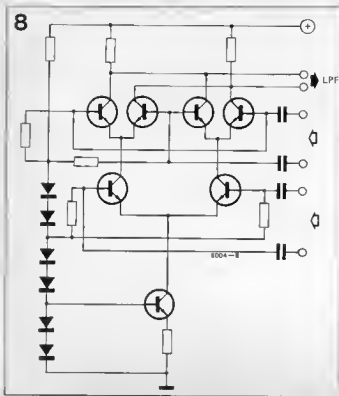

Figure 6a. The symmetrical multiplier is used in almost all PLL IC's and can also be obtained as an IC in its own right. It may be constructed successfully from discrete components also.

Figure 9. An asymmetric multiplier may be used, provided that the low-pass filter can provide sufficient suppression of the input frequencies. This type of circuit is used in the input section of an OTA and a PLL of good performance can, in fact, be built with an OTA type CA3080.

Figure 10. If RF transformers are used, a cheap multiplier may be built using four identical diodes.





the PLL. When it is to be used as an FM detector the linearity (Frequency change v. control voltage change) should be as good as possible, while for frequency synthesis this is unimportant but high stability is essential.

Voltage-controlled multivibrators or varicap-tuned LC oscillators, like those shown in figures 6a and 6b respectively, generally have to be made up from discrete components, while integrated PLL circuits, such as the Signetics 565 shown in figure 7, rely on the triggering principle.

Where a PLL is to be operated with a fluctuating supply voltage the VCO frequency should be independent of voltage, or alternatively a stabilised supply may be used.

b. Phase Comparator

The output from the phase comparator or multiplier must be dependent solely on the product of the signals fed into it. This requirement is basically met by any non-linear component, subject to the proviso that the input signals also appear in the output. It is important to ensure that these signals have no detrimental effect on the performance of the system. An even more important requirement is that the output should not contain any D.C. components resulting from rectification of the input signals, as this can cause 'mistracking' and may even cause the PLL to go out of lock.

If a balanced multiplier as shown in figure 8 is used impairments such as these can easily be avoided. The input signals are suppressed by the circuit and no rectification occurs. If suppression of the input signals is not required it is possible to use an asymmetric multiplier such as the example in figure 9. A circuit of this kind is included in the input of an operational transconductance ampli-

fier (OTA) such as the CA 3080. This IC performs well in PLL circuits.

It will be understood that rectification of the input signals can occur in this case, but nonetheless a satisfactory degree of AM suppression may be achieved.

The best performance in this respect is achieved when the VCO output is fed into the asymmetric input and the input signal into the symmetrical input. The amplitudes of the signals should not exceed 0.5 V and 0.05 V respectively. The degree of AM suppression that may be obtained is almost as high as with a symmetrical multiplier.

If R.F. transformers are available it is possible to use a diode ring modulator as a multiplier as in figure 10, but this is a rather old-fashioned method.

The simplest, but unfortunately also the worst, solution for a phase comparator consists of a single semiconductor device that is fed with a VCO signal large enough to switch it on and off continuously. Because of the inevitable feedback from the circuit to the VCO a buffer stage is essential, as in the arrangement of figure 11. The phase comparator here is reduced to a mixer, so it appears that any mixer may be used as a phase comparator. The problems that it introduces, however, cannot be eliminated without adjustment using expensive test equipment. Symmetrical phase comparators, on the other hand, give satisfactory re-

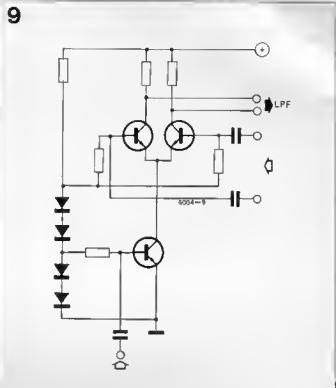
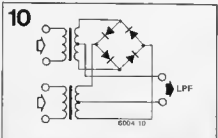

sults with very little outlay on test equipment.

c. The low-pass filter

The low-pass filter (LPF) is the circuit that determines the bandwidth of a PLL. Simple RC filters, a few examples of which are given in figure 12, usually suffice. Examples b, c and d are suitable

for symmetrical phase comparators, while a is applicable to asymmetric arrangements. As a general rule resistor R is already a component in the phase comparator.

Although the calculation of component values for the low-pass filter is easily accomplished when using IC PLL's by referring to the manufacturer's data, sophisticated test equipment is needed to evaluate the performance of a PLL at frequencies in excess of 10 MHz. Filter d is the most suitable for home-built equipment.

The cut-off frequency of the RC combination formed by C_2 and the output resistance of the phase comparator is determined by the lowest frequency to be detected (20 Hz in Hi-Fi FM). The cut-off frequency of the second RC section, formed by P (at its maximum value) and C_1 both connected in parallel with the output resistance, is determined by the maximum PLL input frequency deviation. Any desired bandwidth, up to a maximum determined by the loop gain and the input signal amplitude, may now be set with P.

Problems experienced with PLL's

Theoretically a PLL detector exhibits great advantages over other FM detectors, but in practice these are difficult to realise fully. There are two basic critical factors:

1. VCO frequency stability
2. Signal/noise ratio

To obtain good stability the D.C. supply to the VCO must be temperature-compensated, and this applies also to the phase comparator if the control input to the VCO is asymmetric. In addition the components whose values affect VCO frequency should have zero temperature coefficients. These requirements are difficult to meet and in practice the VCO centre frequency often drifts several percent over the working temperature range. For this reason it is advisable to choose the lowest possible working frequency. The lowest usable working frequency depends on the FM signal bandwidth and with the 200 kHz usual in FM broadcasting satisfactory operation is possible with a working frequency as low as 450 kHz. Frequency drift at this low working frequency may be neglected; however, a receiver using this principle must employ double conversion techniques (i.e. it must be a double superhet receiver) and will inevitably cost more than a conventional receiver.

Both the VCO and the phase comparator generate some noise, so the demodulated signal level must be as high as possible in relation to that noise. The PLL output-signal amplitude is proportional to the quotient of the deviation f and the working frequency, which in a receiver is of course the intermediate frequency f_{IF} . With an intermediate frequency of 10.7 MHz and a deviation of 75 kHz this quotient is about 0.007, while with an IF of 450 kHz it is 0.17 so that the lower frequency improves the signal-to-noise-ratio by about 28 dB.

A PLL constructed from discrete components, working at 450 kHz and using the phase comparator of figure 8 and the VCO of figure 6a, can achieve a signal-to-noise-ratio of 60 dB on a stereophonic broadcast.

Feedback PLL

As outlined above, the main problem when using a conventional PLL as an FM detector arises from the standardisation on 10.7 MHz as an IF frequency. This means that practically all commercially available FM front-ends have an IF output at this frequency. In addition, special provision has to be made for the derivation of an automatic frequency correction (AFC) control voltage from the PLL. However, by removing some of the components from the AFC loop in a conventional tuner the local oscillator can be used as a VCO. The linearity of such a VCO can be quite good since the 75 kHz deviation is small in relation to the working frequency (around 100 MHz). The reference frequency for the phase comparator can be supplied by a stable oscillator in which the frequency-determining element is a quartz crystal or a ceramic filter, so that VCO phase jitter noise, which is relatively strong at 10.7 MHz, is avoided.

Figure 13 is a block diagram of a feedback PLL. The aerial signal is mixed with the output from the tuneable voltage-controlled oscillator (TVCO) to give a 10.7 MHz signal that is fed through

11

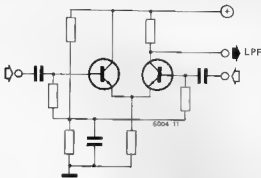

Figure 11. This circuit may be used as a phase comparator, but unwanted demodulation products arise due to modulation. This precludes its use as an FM detector.

12

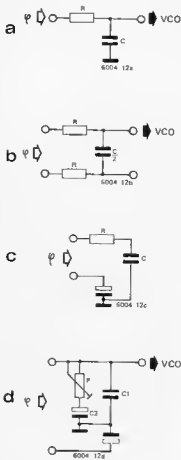
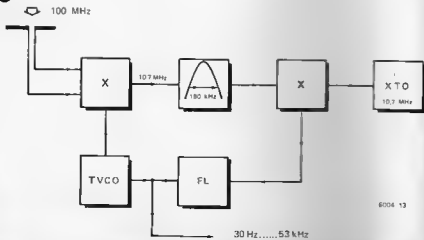

Figure 12. Of these low-pass filter circuits version d is best for home construction as it is least critical to set up.

Figure 13. Feedback PLL differs essentially from conventional PLL insofar as it includes the IF filter in the control loop. This results in a substantial reduction in the IF signal deviation, to the extent that the IF bandwidth can be low enough for m to be unity or less. This makes alignment of the bandpass filter exceedingly critical and for these reasons it is better to choose a larger bandwidth. There are a number of feedback PLL systems in which the principal aim is to maintain the modulation index as consistently as possible at unity. The complexity of such systems, however, as well as the difficulty of aligning them, limits their use to radio amateurs with sufficient theoretical knowledge and to space-travel communication.

13



an IF filter to the phase comparator. The other input to the phase comparator receives a high-stability 10.7 MHz reference signal from the reference oscillator, thus, when the signal is locked in, the TVCO follows the aerial signal deviation. This means that the deviation of the 10.7 MHz signal is considerably reduced, hence the name 'Feedback PLL'. Because of this reduced deviation the IF bandwidth is much smaller than in a conventional receiver.

In the article entitled 'Modulation Systems' the minimum bandwidth of an FM signal is given as:

$$b_{\min.} = 2(m + 1)f_{LFmax}$$

and this relationship is valid when $m > 1$. In a feedback PLL, however, the IF-signal modulation index is considerably less than 1 which accounts for the reduced bandwidth. The significant advantage of a feedback PLL system lies in the IF bandwidth, which becomes independent of deviation and in fact depends only on the highest modulation frequency. This gives improved signal-to-noise ratio and lower distortion compared to a conventional receiver, although the degree of improvement depends on the original modulation index of the aerial signal.

For mono FM transmissions, with a maximum modulation frequency of 5 kHz and a modulation index of 5, the IF bandwidth in a conventional receiver must be 180 kHz, whilst the bandwidth in a feedback PLL receiver is only 30 kHz. The ratio is considerably less unfavourable for stereo transmissions however, as the highest modulation frequency of 53 kHz means that the feedback PLL IF must have a bandwidth of 106 kHz. The principle of feedback PLL was known before the introduction of stereo FM broadcasting but unfortunately this did nothing to prevent the introduction of multiplex stereo systems and so any improvements that might have been made in stereo reception were thrown away.

It is still true to say, however, that a feedback PLL receiver similar to figure 13 gives a considerable saving in cost compared to a conventional receiver with comparable performance. Feedback PLL systems are of particular interest to radio amateurs, because significant improvements in signal-to-noise ratio may be realised if a low maximum modulation frequency is specified. However, as far as the author is aware, little work has been carried out in this field. This is surprising as the principles involved have been known for many years and the VHF and UHF amateur bands offer unlimited possibilities for experimentation.

Summary

PLL is particularly suitable for frequency synthesis and for demodulation of FM signals. When used as an FM detector the relative deviation of the input signal should be as high as possible. This involves the use of multiple frequency

conversion which is too expensive for the consumer market and too complicated for many home constructors.

Feedback PLL's may be used at high frequencies and offer the advantages of reduced IF bandwidth and lower distortion with the absence of conventional AFC. Full exploitation of the potential of feedback PLL's is probably too expensive for consumer applications. Nevertheless, simplified feedback PLL circuits

are feasible and are indeed cheaper than conventional receivers. They should, therefore, be of interest in consumer electronics.

VHF and UHF radio amateurs are particularly well placed to take advantage of feedback PLL techniques, as their own experience makes them familiar with the RF work involved.

A simple feedback PLL FM receiver will be described in a future issue of Elektor.

J. Wittje

decimal to bcd converter

This converter can be used as a manual encoder which will convert decimal coded signals into BCD codes and drive digital circuits. Furthermore, the converter can be used as a teaching aid for explaining the BCD code.

One IC and six germanium diodes are sufficient for converting a decimal number into a BCD number. A switch for zero is not provided because the converter automatically indicates zero when all

switches are open. The reverse resistance of the diodes must be as high as possible (if necessary, check with an ohmmeter) and the gate inputs can be provided with a pull-up resistor connected to the positive supply voltage.

If the circuit is to be used to explain the BCD code, the BCD-output conditions can be indicated by means of LEDs. The circuit for the required buffer stage is shown in figure 2.

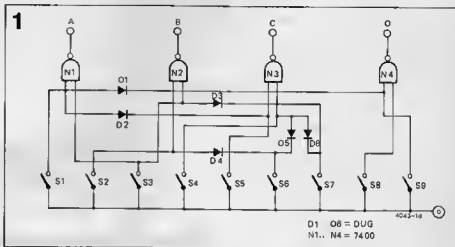

Table

D	C	B	A	Decimal
0	0	0	0	0
0	0	0	1	1
0	0	1	0	2
0	0	1	1	3
0	1	0	0	4
0	1	0	1	5
0	1	1	0	6
0	1	1	1	7
1	0	0	0	8
1	0	0	1	9

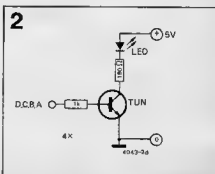

A. Seitz

fido

Fido is a new electronic game in which an unfortunate dog is called by four masters at the same time.

The command "Fido come" is given by means of a pushbutton. At each push on one of the four buttons controlled by each player Fido jumps in the required direction. However, the four masters and/or mistresses have one handicap: After one successful command to Fido, the would-be Fido owner who has given the order has nothing more to say for a certain time. Then the other players can go on with Fido. If one of the players succeeds in getting Fido into his kennel, the game is decided: Fido stays where he is.

Construction and operation

Since Fido is clever enough to let himself be represented by a small incandescent lamp, he is not going to suffer from an otherwise unavoidable nervous breakdown. The worst that can happen is that after a prolonged fight for mastery over Fido our doggy will suffer from a flat battery.

On the playing board nine lamps are arranged in a square (figure 1). On the extension of each side there is a lamp representing a kennel (so in total four). Furthermore, at each of the corners there are four push buttons with a pilot lamp in four directions (away, towards, left or right with respect to the particular player). The photograph also shows that the "gaming table" is provided with an on/off switch, an interval switch (coarse) and an interval control (fine) for setting the obligatory rest period for the players. These switches can be calibrated "blood-hound/whippet" and "dog-tired... alert" respectively.

Furthermore there is a switch to disable the "rest" lamps and there is also a starting switch. By pushing this button, Fido takes up his position in the centre of the field; i.e. the middle lamp is alight. By pushing one of his buttons, each player can now try to direct Fido into his kennel. Once a player has pushed a button, he is obliged to take a breather before he can push a button again. The lamps fitted near the buttons indicate when the next command can be given. Each player can give only one command at a time. If an impatient player pushes his button too soon, the penalty is a new start of the waiting period. So Fido will not respond to a command that comes too early.

To make the game a bit more exciting, the pilot lamps can be switched off, so that each player must just guess when he may next give a command.

The block diagram

Fido's position in the field is indicated

by nine lamps arranged in a square. These lamps are located at the intersections of 3 x 3 matrix rails. The signals for these rails are driven by two left/right shift registers. The clock pulses to the registers are produced by the players pushing one of the buttons. Since each player has four buttons at his disposal, Fido can be sent in all directions including the kennel of another player.

The directing signals for left, right, up and down are coupled into the registers via the multiplexer. Once in a corner, the dog can be made to jump into the kennel situated below the corners as seen from the player's position. The register input driving the "kennel" flipflop is so connected that the command for jumping is only followed if the other register, too, is in the proper position. The lamp field is blocked to prevent lamps from lighting up after a jump into the kennel. At the same time all register outputs are blocked so that no more "kennel" flipflops can be driven.

The game is started by pushing the starting button; then all the "kennel" flipflops are reset and the two shift registers take up a central position. In that case the middle lamp is alight.

The left/right shift register

Figure 3 shows how a flipflop can be turned into a "flipflopflap". The inputs of each hand are connected to the outputs of the other hands. Consequently, only one output at a time can be low ("0"). This "0"-signal produces a high output level ("1") at all the other hands; these high levels in turn cause the low output level on the first hand. A negative-going pulse on one of the coupling rails causes all hands connected to this rail to change to "1", whereas the hand whose output is connected to this rail ensures that this rail remains "0".

If gates with a so-called totem-pole output are used (7400, 7420 and 7430) the outputs must be separated by means of a diode as otherwise none of the

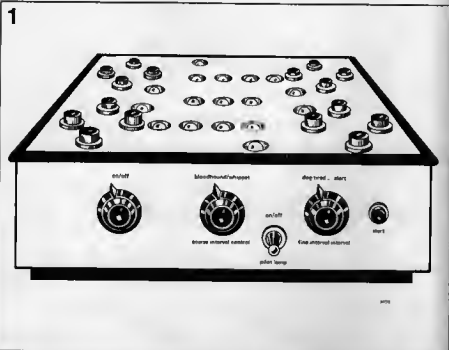

Figure 1. Artist's impression of Fido.

Figure 2. The block diagram. The command units also comprise the waiting time indication. The push button "start" resets all "kennel" flipflops and sets the lamp in the center of the field lights up. Multiple connections between the circuits are indicated by means of broad arrows.

Figure 3. The development of a multiple flipflop starting from the fundamental principle.

- Two methods of drawing a simple flipflop
- A 3-fold flipflop
- A 5-fold flipflop.

outputs would change to low (figure 3c). With types with an open collector output this is not strictly necessary, although it is recommended to keep the input load of the pulse low.

In that case the "0" must, after each pulse, shift one position to the right, left, top or bottom. So we need a memory which remembers what coupling rail is carrying a "0" signal before the pulse, and a circuit that determines in what direction the shift should take place.

The memory is formed by C_1 , (C_2 , C_3 , figure 4); the direction of shift is determined by two nands (N_3 and N_4 , N_5 and N_6 , N_7 and N_8) which receive their signals via N_1 and N_2 . When the button is pushed, say left, this is what happens: Via N_1 , connected as an inverter, the "1" signal is fed to the nands N_3 , N_5 and N_7 via the "left" conductor. At the same time all the connecting rails are brought to the "0" level via the diodes D_1 , D_3 , D_4 and D_5 . As a result, the nand N_9 ,

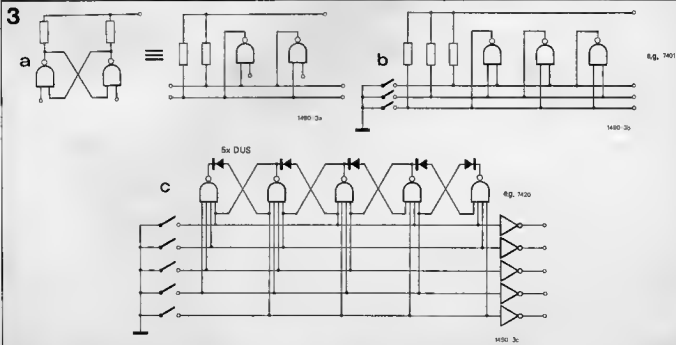
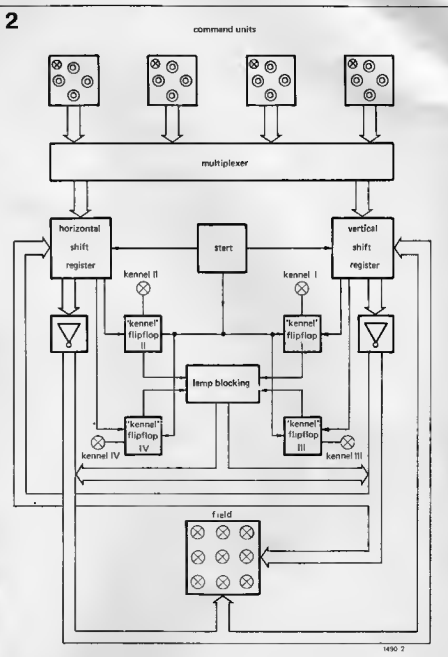

4

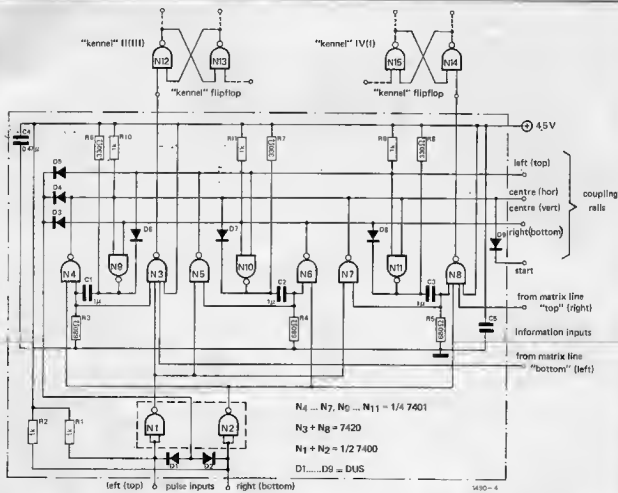

5

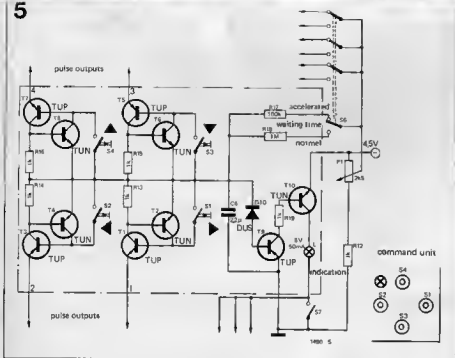

N_{10} or N_{11} , which has been at "0" level so far, changes to "1". Simultaneously, a positive pulse is fed to the two adjacent nands via the capacitor connected to this output. The gate thus prepared by the "1" signal via the conductor "left" maintains the collecting line of its neighbour at "0" until again via diode D_1 the "0" signal disappears and the remaining

conductors become logically "1". The contact potentials of the diodes D_1 and D_2 up to and including D_2 ensure that the coupling rails reach the "1" potential before the inputs of the gates 1 or 2. This is necessary to ensure that the new main nand takes over the "0" signal before the direction determining gate changes back to "1".

Figure 4. Complete "shift register for a zero" 3-fold, for the matrix line of the horizontal shift register. The vertical register is of the same construction (description between brackets).

Figure 5. Field with waiting time indication. Depending on the type of field used, the trigger unit is required several times. It serves to suppress contact bounce.

Figure 6. Diagram for Fido with nine lamps. If the whole is fed from batteries, it is advisable to supply the lamps from a separate battery because pulses caused by switching (low filament resistance of an extinguished lamp) might interfere with the circuit. The bias of C_5 (figure 6) must also be obtained from a separate battery because a maximum current of about 200 mA can occur.

In the extreme positions for the "shift register for a zero", the "kennel" flipflops N_{12} - N_{13} and N_{14} - N_{15} are driven. These may be driven only when the second register reports the correct position. The other direction determining gates N_3 and N_8 , which drive the "kennel" flipflops require three inputs for that purpose; one being coupled to the corre-

6 waiting time (coarse)

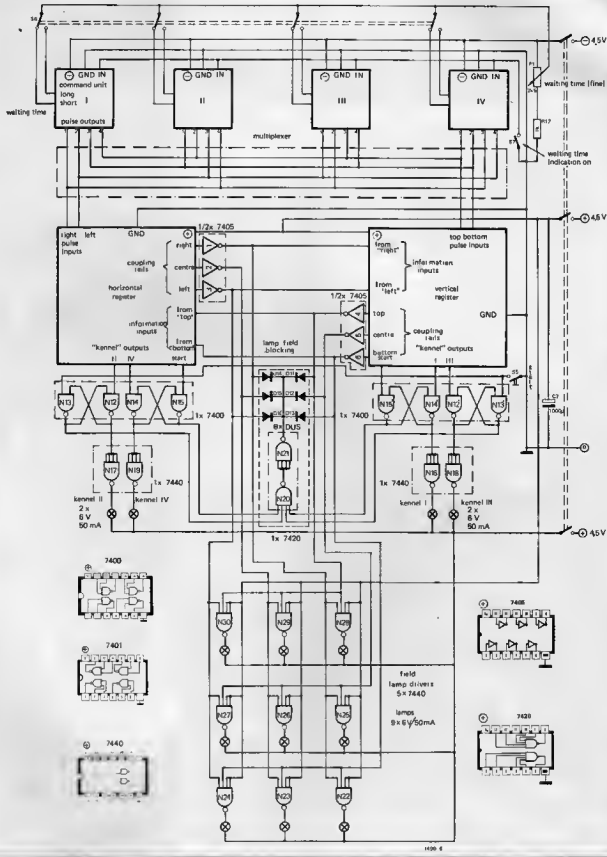

sponding matrix line of the other register.

Command-unit with indication

Figure 5 shows a command-unit with four push buttons. The other units are similar.

Via P_1 and R_1 , or R_{10} , respectively, capacitor C_6 is negatively charged until the voltage across C_6 equals the sum of

the contact potentials of diode D_{10} and the base-emitter junction of T_9 . The latter is then conductive, so that T_{10} causes the lamp to light up. The pilot lamp indicates when a command can be given. The waiting time can be adjusted with P_1 .

When pushing a button, say S_1 , T_1 is turned on by the negatively charged

capacitor C_6 , so that the emitter of T_1 drops from +4,5 V to +0,7 V. This pulse serves to drive the shift register.

Due to contact bounce, Fido is likely to make wild and unpredictable jumps, or just stays where he is. To avoid such "disobedience", each push button must be connected to a trigger. Even the shortest pulse at the base of T_1 is suffi-

Figure 7. Arrangement of the "kennel" lamps for a field of 5 X 5 lamps.

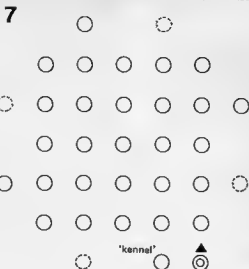
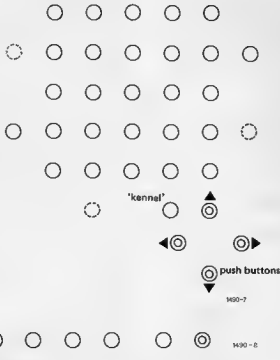

Figure 8. Mini Fido.



cient to cause the two transistors (T_1 and T_2) to switch. As a result capacitor C_6 is connected to the control line until the voltage drop across R_{13} caused by the charge current is no longer high enough, and the trigger returns to its initial position. Then capacitor C_6 discharges across R_{17} (R_{18}) and P_1 .

The complete diagram

Owing to the large extent of the circuit, some of the sections are represented as blocks in figure 6. The positions indicated by the coupling rails are represented by "0"-signals. For the remainder, only "1"-signals are used; hence the inverters 7405 for inverting the signals. These signals are fed to the lamp drivers 7440 which cause the lamps to light up when all inputs are "1".

Since only two of the four inputs of the lamp drivers are used, all the others can be connected to the positive of the supply, which, however, is not necessary. Once Fido has disappeared into a kennel, that is to say: when a "0" signal has reached the input of a goal flipflop, a "1" is produced at the driver of the goal lamp, and a "0" at the gate N_{20} , which via the inverter N_{21} and six diodes D_{11} up to and including D_{16} , transfers this signal to the outputs of the inverters I_1 up to and including I_6 . As a result all the lamps in the field are extinguished. Furthermore, all the outer direction-determining gates (figure 4) are blocked ("0"-signal at the inputs that are connected with the inverter outputs), so that no further goal can be scored by the now invisible Fido, if more buttons were pushed.

The start- or reset button returns the goal flipflops and the registers to their initial positions again. The middle coupling

rails must be connected to the reset conductor via the diodes (D_9 in figure 4). The words "left", "right", "top", "bottom", "vertical" and "horizontal" are related to a group of push buttons which is fixed by an arbitrary position of a player and is called command-unit 1. The other command-units are numbered clock-wise. The arrows in figure 5 are related to the way in which Fido moves as regards the player concerned.

Variations

The game can easily be changed. A first possibility is to expand the field so that the game will last longer (figure 7, according to the principle in figure 3c). This will, of course, increase the cost of the unit by a considerable amount, especially if the 25 lamp version of figure 7 is used. Furthermore, it should be noted that the field is in fact only suitable for four or eight players, whereas the smaller field can also be used by two without Fido endlessly running up and down.

On the other hand, the field with 25 lamps can easily be connected to eight command-units, so that eight "dog lovers" can join the game.

A "mini Fido" is also a possibility if we restrict ourselves to one register (see figure 3c), and if the "kennels" are placed at the two ends of the row of lamps (figure 8). In spite of the simple set-up the game can still be fun; playing with the push buttons alone is most amusing. In addition this version offers the possibility of studying the register.

Of course, other possibilities can be worked out, but then again it is up to the reader to find an arrangement in accordance with his taste and, lets face it, budget.

elektor services to readers

EPS print service

Many elektor circuits are accompanied by printed circuit designs. Some of these designs - but not all! - are also available as ready-etched and predrilled boards, which can be ordered from our Canterbury office. A complete list of the available boards is published under the heading 'EPS print service' in every issue. Delivery time is approximately three weeks.

As a further service, boards which are taken off the regular service list at some future date will continue to be available in spite of this; delivery time will then be approximately six weeks. It should be noted, however, that only boards which have at some time been published in the EPS list are available; the fact that a design for a board is published in a particular article does not necessarily imply that it can be supplied by elektor.

Technical queries

Members of the technical staff will be available to answer technical queries (relating to articles published in elektor) by telephone on Mondays from 14.00 to 16.30. Queries will not normally be answered at other times.

Letters should be addressed to the department concerned: TQ = Technical Queries. Although we feel that this is an essential service to readers, we regret that certain restrictions are necessary:

1. Questions that are not related to articles published in elektor cannot be answered.
2. Questions concerning the connection of elektor designs to other units (e.g. existing equipment) cannot normally be answered, owing to a lack of practical experience with those other units. An answer can only be based on a comparison of our design specifications with those of the other equipment.
3. Hieroglyphs or illegible handwriting cannot be decoded; provided the sender's address is legible, the letter is returned unanswered.
4. Questions about suppliers for components are usually answered on the basis of advertisements, and readers can usually check these themselves.
5. As far as possible, answers will be on standard reply forms.

We trust that our readers will understand the reasons for these restrictions. On the one hand we feel that all technical queries should be answered as quickly and completely as possible; on the other hand this must not lead to overloading of our technical staff as this could lead to blown fuses and reduced quality in future issues ...

H.U. Heinz

time machine

Slowly-developing technological processes or natural events cannot be perceived because the eye is generally not able to distinguish the separate stages. Such events and processes can, however, be visualised by means of cinematographic time compression. An interval switch linked with a camera enables it to make single exposures at set intervals. When run at normal speed the film then shows a process or event apparently developing continuously, but in a much shorter time.

The block diagram of the interval switch is given in figure 1; it consists of a pulse generator, two monostable multivibrators and a stabilizing circuit. A mechanism controls the automatic diaphragm and shutter of the camera. The pulse generator consists of a UJT (unijunction transistor) relaxation oscillator with adjustable pulse recurrence frequency. The output pulse drives two interconnected monostable multivibrators (MMVs) which control the mechanism for diaphragm adjustment and

camera shutter. Because the circuit must be suitable for battery supply, a stabilizing circuit ensures a constant voltage throughout the battery life. Of course, the circuit can also be fed from a mains power supply.

MMV1 controls the automatic diaphragm of the camera. This diaphragm setting is maintained until MMV2 operates the shutter and resets the entire circuit to its initial state.

The stabilizing section included a battery voltage indicator which operates

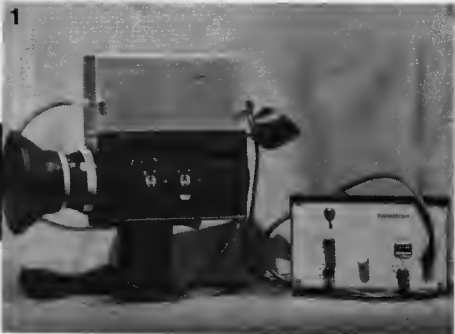
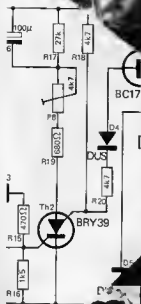

Photograph 1. The time compressor system for film cameras. The box mounted on the camera contains the relays and the shutter drive motor; the box beside it contains the electronics.

with an 'expanded scale' and 'suppressed zero' so that it only reads from about 12-20 V. Since the circuit will not function correctly if the battery voltage falls below 12 V, there is no point in measuring below 12 V. It is simply a waste of meter scale space.

The pulse generator

Figure 2a shows the principle of the pulse generator. Capacitor C_1 charges via R_1 to the breakdown voltage of the UJT, to discharge again via resistor R_2

and the E-B₁ junction of the UJT. The breakdown voltage of a UJT is an almost fixed percentage of the supply voltage, usually between 60% and 85%, depending on the type.

Positive pulses appear across resistor R₂ with a repetition frequency that can be adjusted within certain limits by changing R₁.

In the circuit of figure 2b, P₁ is the potentiometer with which the repetition frequency is adjusted. The adjustment range of P₁ is determined by the series connection of R₁ and P₂ in parallel with P₁. Via the selector switch S₂ this combination is connected to the series resistors R₃ + P₃ ... R₆ + P₆ which are connected to the supply.

Terminal B₂ of the UJT is connected to the supply via resistor R₇. This resistor serves to reduce the temperature dependence of the UJT.

In the blocked condition, the E-B₁ junction of the UJT has a very high resistance so that it is possible to achieve relatively long pulse times with large capacitances (220 μ) and high resistances (maximum 1 M).

Switch S_{1,1} is combined with the on/off switch; in the centre position C₂ charges rapidly via R₂, so that the UJT can produce the first pulse the moment the on/off switch is operated. If the capacitor were not given an initial charge in this way, the waiting time for the first pulse would be 4 minutes in the worst case.

Transistor T₂ serves as an inverter, so that the pulse generator supplies both positive and negative pulses.

The Monostable Multivibrators (MMVs)

The two MMVs connected after the pulse generator are equipped with thyristors with anode- and cathode-gates because these can fire on positive as well as on negative pulses. Both MMVs are of the same design, differing only in component values.

Figure 3 shows the circuit of an MMV. Once thyristor Th₁ has been fired by negative-going pulses on the anode-gate, it remains on until the current drops below the so-called holding current. If in the anode circuit of the thyristor a resistor is included of such a value that the holding current of the thyristor cannot be reached, the thyristor will not fire.

If, however, a capacitor (C₄) is now connected parallel to this resistor, the thyristor will fire and the capacitor will begin to charge. Since, however, the charging current of a capacitor decreases as the charge increases, there comes a

certain moment when the current flowing through the parallel circuit of resistor and capacitor drops below the holding current, and the thyristor blocks again. The capacitor then discharges through the parallel resistor R₁₀ (figure 3).

A variable series resistance (P₇ + R₁₁) determines the charging time of the capacitor and thus the time during which the thyristor remains on. In addition, this series resistance protects the thyristor against excessive switch-on currents. Via R₁₄ and D₁ the thyristor drives switching transistor T₃ which energises relay RLA. Diode D₂ protects the transistor against voltage surges when the relay cuts out.

Current supply and measuring circuit

The supply voltage is stabilized at about 11 V by ZD₁ and T₃ (figure 4). All battery voltages can be measured under load and no-load conditions via switch S₄. As long as the measured voltage is higher than the zener voltage, a current I flows through the parallel circuit (R₂₂ + P₁₂); the resulting voltage drop is measured with the measuring instrument. The meter is adjusted to full-scale deflection (f.s.d.) by means of P₁₂. The currents through the zener diodes ZD₂ ... ZD₄ can be adjusted with the potentiometers P₉ ... P₁₁. These zener diodes ensure that only voltages higher than the minimum voltages on which the apparatus functions properly are measured. The meter thus has a 'suppressed zero', i.e. it only reads from (say) 12 V upwards since voltages below this are of no interest. The whole meter scale may then be calibrated for 12-20 V.

The residual battery charge can be estimated on the basis of the difference in meter deflections when readings are taken with and without load.

The extra positions on S₄ are for testing other batteries in the camera. The diodes ZD₃ and ZD₄ can be chosen to give a suitable 'suppressed zero' value for other battery voltages.

The complete circuit

The complete circuit given in figure 5 is intended for the Zeiss G.S-8 synchronous camera. In this case the diaphragm is adjusted by a motor, so that it remains in the set position when the control current is switched off. The camera is fitted with two external connections for electrically-operated remote release; one for single exposures and one for running exposures. Before the release is operated, the diaphragm must be properly adjusted.

The negative pulse produced at the collector of T₂ first starts MMV1 which, via RLA1 (figure 6) switches on the automatic aperture control for about 2 sec., giving ample time for this control to find its setting before the shutter opens. The moment MMV resets, a positive pulse starting MMV2 occurs at the anode-gate resistor (R₁₃). As a result RLB is activated, closes contacts RLB1, and starts a motor which drives the camera shutter.

Although RLA is no longer energised, the diaphragm motor will hold the aperture at its correct setting. The diaphragm drive can be switched off altogether with S₃, so that, for example, an electronic flash can be used with a preset aperture. S₅ operates RLB directly and can therefore be used for manual shutter operation.

There are almost as many automatic exposure devices as there are camera types. Consequently the matching of the automatic operating equipment to the camera diaphragm and shutter mechanisms often calls for considerable care.

Another type of automatic exposure control which is found in most cameras nowadays uses a moving coil (as in a meter) to control the diaphragm according to the photocell response. In this case, the circuit operating the diaphragm control must remain switched on when the shutter opens. This can be achieved by providing an extra pair of contacts

Figure 1. Block diagram of the time controller.

Figure 2a. Circuit diagram of a pulse generator using a UJT.

Figure 2b. Diagram of the pulse generator.

Figure 3. One of the two MMVs with which the diaphragm control and shutter are operated.

Figure 4. This stage serves for voltage stabilizing and checking the operating conditions of the batteries.



RLB2 on the shutter relay RLB: these will be in parallel with the contacts RLA1 of relay RLA which turn on the automatic exposure control before the shutter opens (figure 6). At the moment when MMV1 resets and de-energises RLA, RLB will keep the diaphragm control in operation, by contacts RLB2,

until the shutter has closed.

At the indicated value for C_6 , a camera which had no single-exposure facility would expose about 10 frames. The value of C_6 for single exposures would be about 8μ . The number of frames transported during a single pulse from MMV2 can be ascertained by pressing a

numbered strip of leader film, with the finger, against the film gate and traction claws.

The camera can be switched to 'filming' by S_5 . If single manual exposures are required for trick shots, MMV2 can be turned on by a switch as shown in figure 7. If the automatic diaphragm

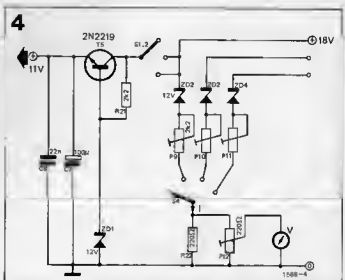
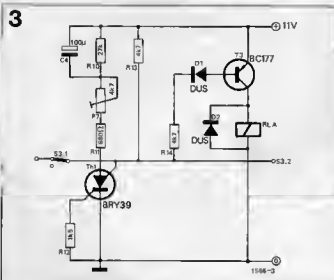
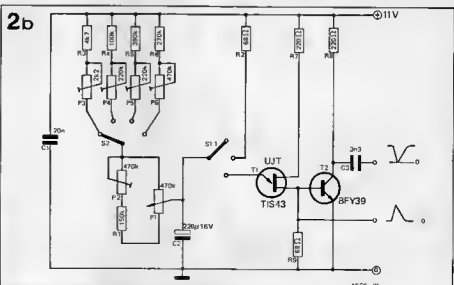
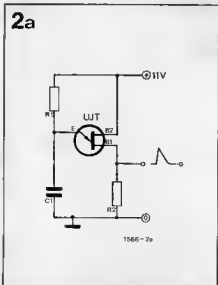
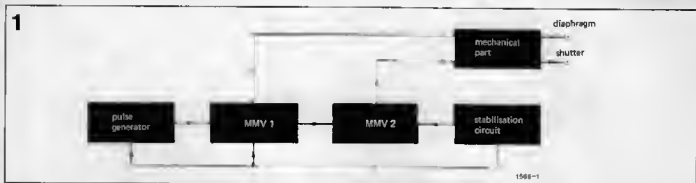

is also required to function for these shots, three components must be added to the cathode gate circuit of T_{H2} : a $3n3$ capacitor, a $470\ \Omega$ resistor and a diode (DUS). This must be done in the same way as with MMV2 (here it is C_5 , D_3 and R_{15}). The push-button of figure 7 must then be connected direct to the additional capacitor.

If the current consumed by the automatic exposure control is known to be small, the control can be left on continuously during time-compressed filming. It will then be possible to dispense with T_2 and associated components, as well as with MMV1 and RLA. One pair of contacts on RLB will suffice.

It can be gathered from what has been said that adapting the circuit to a particular make and model of camera not only calls for a precise knowledge of the camera; it also requires considerable experience in the field of electronics. Anyone who undertakes this project should be capable of tackling

any precision engineering work that may have to be done on the camera.

Aligning the circuit

Before the apparatus can be used, the following adjustments must be made.

1. P_1 to zero, P_3 to give maximum pulse interval. This will be about 2 sec. for a mechanical shutter and about 0.5 sec. for an electric shutter.
2. P_4 , P_5 , P_6 to 1, 2, 3 minutes respectively.
3. P_1 in position 'maximum'. Adjust P_2 until the difference between the minimum and the maximum positions of P_1 corresponds to 1 minute.
4. P_7 to a time which enables the automatic exposure control to re-adjust by two stops.
5. P_8 to give the minimum time the shutter mechanism needs to operate the shutter when the battery is low.
6. Adjust S_1 and S_4 to 'off' position, P_9 , P_{10} and P_{11} to give 2.5 ... 5 mA measured between the contacts of S_4 . Adjust P_{12} to full-scale deflection of the meter.

When choosing the zener diodes (ZD_2 ... ZD_4) take into account the minimum voltages at which the equipment will still function properly at low temperatures. If the zener voltages are changed, other values may have to be chosen for the adjustment potentiometers.

Figure 5. The complete circuit of the time compressor.

Figure 6. Relay contacts for cameras with motor-driven or moving-coil diaphragm control.

Figure 7. Additions for manual single-exposures for trick films.

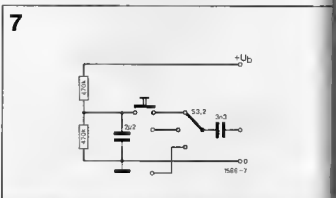
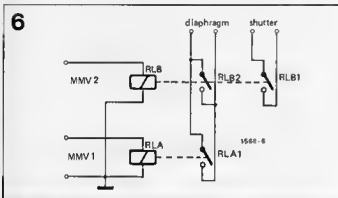
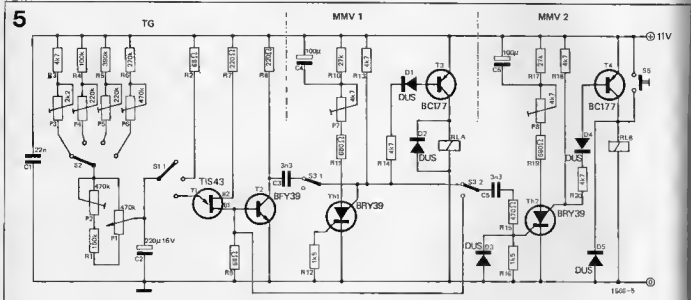

The shutter mechanism (for mechanical shutters)

As is apparent from the previous examples, cameras with electric shutters are easily modified by bridging the the release contacts by the relay contacts. With mechanical shutters however the release button must be operated by a servo or other device. No detailed data can be given on the release mechanism because the construction depends largely on the camera used. The author used a Graupner Varioprop-Servo from which the feedback potentiometer had been removed. This was used to drive the shutter release via a Bowden-cable type remote release. Limit switches were incorporated to limit the servo travel. A model control servo which may be adapted to a shutter drive for most cameras will be obtainable in a shop for model builders.

Exposures with the time compressor

To conclude with, some remarks about the exposure technique. To ensure a flowing motion, calculation of the intervals should be based on 900 frames, so that at a projection speed of 18 frames per second the projection time is 50 seconds.

If the interval is indicated as t seconds per frame (F), and the time in which the compressed event takes place is T hours, we have:

$$t = \frac{T}{900} \times 3600 = 4 T (s)$$

in which T is in hours, and t is in seconds.

For an opening rose the interval for an exposure time from 0530 to 2030 (exactly 15 hours) is

$$t = 4 \times 15 = 60 \text{ seconds per frame.}$$

When filming outdoors, don't forget to immobilize the flower in case it should sway in the wind.

Editorial note

A number of notes as regards component values may be noted:

All electrolytic capacitors must be of the 16 or 25 V type.

For T_2 a BC 140 may be used instead of a BFY 39. Furthermore, it is advisable to connect a resistor of 1 k in series with the base of T_2 .

In figure 4 transistor T_5 (2N2219) may be replaced by a BD 137 or BD 139. In many cases this transistor will also have to be cooled, certainly if the two relays draw considerable current (over 100 mA).

Finally it should be noted that in figure 4 '+V_B' is the output of the stabilized supply. So this point is the supply point ('⊙') in figures 5 and 7. The voltage is about 11 V. **M**

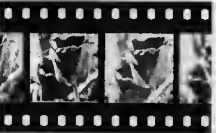

marine diesel

Apart from ship sirens and fog horns, builders of ship models are also interested in imitating marine engine noises. With only a few components the 'marine diesel' circuit lends realism to a model.

The noise produced by a diesel-driven ship is made by the thump of the engine and the regular puffing of gases escaping through the exhaust. The noise of these escaping gases is imitated by a small noise generator in the circuit. The thump effect is achieved by using an IC in a trapezium generator circuit, with the noise added on the leading and trailing edges. The figure shows the circuit. The base-emitter junction of T_1 is reverse biased to breakdown and the resulting noise signal is fed to the non-inverting input of the operational amplifier. The feedback network, formed by R_4 , R_5 , R_6 and C_3 then determines the form of the trapezium voltage. As long as the IC has not reached saturation, the output produces a voltage ramp with superimposed noise. The noise is suppressed as soon as the IC reaches saturation. An oscilloscope connected to the output of the circuit should show one of the waveforms drawn in the diagram, depending on whether the DC-connected or the AC-connected oscilloscope input is used.

If after completion of the circuit it is found that the sound produced by the model is too slow, certain modifications may be made. C_4 affects the noise; C_2 , R_6 and R_7 determine the repetition rate. The output of the circuit can be connected to the input of an amplifier. A resistor (value to be found by experiment, depending on amplifier sensitivity and input impedance) connected between the circuit and the amplifier prevents overdrive of the amplifier. **M**

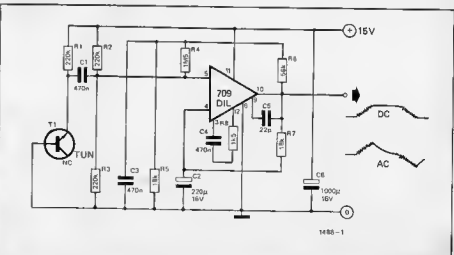

J. Jacobs

noise generator

Despite its simple design, this circuit is a universal noise generator which produces a very high noise amplitude. Transistor T_1 is connected as a zener diode and is connected to the base of the second transistor (T_2). The current through the zener transistor, and hence the amplitude of the noise, is adjusted by resistor R_1 . This noise voltage is then amplified by T_2 .

The supply voltage can be varied over a wide range and, depending on the required output voltage, can be chosen between 10 V and 30 V. At a number of

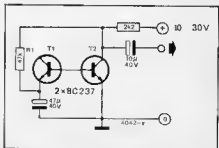

different supply voltages the following noise output voltages were measured:

$$+V_B = 12 \text{ V} - 5 \text{ V}_{pp}$$

$$+V_B = 15 \text{ V} - 8 \text{ V}_{pp}$$

$$+V_B = 20 \text{ V} - 10 \text{ V}_{pp}$$

$$+V_B = 25 \text{ V} - 15 \text{ V}_{pp}$$

If required, transistor T_1 serving as the zener diode can, of course, be replaced by a real zener of 6-8 V. **M**

part 2

minidrum

The Minidrum described in the previous issue may, by the addition of various extra circuits, be extended to a comprehensive manual drum kit. Some new instruments, a three channel ruffle system and an automatic bassdrum are described in this article.

The basic Minidrum contained only three instruments, a bassdrum, a snaredrum and a cymbal and so only three channels of the TAP were used. Since the TAP board has facilities for six channels the design example given here is based on six instruments. The number of instruments may, of course, be extended to suit individual taste by adding extra TAP boards, one for every six additional instruments.

A pulse generator is included in the design. This is intended to drive the automatic bassdrum, but may be used to drive other instruments either separately or simultaneously.

The ruffle system comprises three ruffle channels driven by a single oscillator. A pulse train appears at one of the outputs when a finger is placed on the appropriate touch contact. This may be used to drive any of the instruments to give drum rolls etc.

The first part of the Minidrum to be described is the TAP circuit which controls the instruments via touch contacts.

The Minidrum TAP

Figure 1 is the circuit diagram of the complete Minidrum TAP. It has six touch inputs and six outputs, corresponding to the six instruments used in the design.

As described in the previous issue each TAP channel consists of a COSMOS inverter (I₁-I₆) followed by a diode and an integrating network. Hum from the player's skin causes the output of the inverter to switch between logic 0 and 1, charging capacitor (C₁-C₆). This output voltage controls the relevant instrument. The 47 k resistors (R₇-R₁₂) limit the base current of the one-shot associated with each instrument.

Two types of RCA COSMOS IC may be used for the TAP, CD4009AE or CD4049AE. When using the former diode D₁ must be included in the circuit (see figure 1), if, however, the CD4049AE is used, D₁ may be replaced by a wire link on the p.c. board.

Due to the high noise immunity and wide supply voltage tolerance of COSMOS circuits a sophisticated power

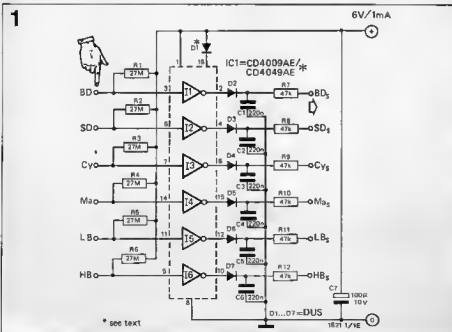

Table 1.

Components list
for figures 1 and 2.

Resistors:

R₁...R₆ = 27 M or 10 MR₇...R₁₂ = 47 k

Capacitors:

C₁...C₆ = 220 nC₇ = 100 μ/10 V

Semiconductors:

IC = CD 4009 AE or CD 4049 AE

D₁...D₇ = DUS

Table 2.

List of components common to all
gyrator instruments (figures 4 and 8-13).
Components for specific instruments
are listed in table 3.

Resistors:

R₁, R₂, R₅, R₆ = 10 kR₃, R₄, R₇, R₈ = 470 kR₁₂...R₂₁ = 6k8

Capacitors:

C₁₀ = 100 μ/10 V

Semiconductors:

C₁...C₅ = DUST₁...T₄ = TUNT₅, T₇, T₉ = BC 107, BC 108, BC 109T₆, T₈ = BC 179, BC 178, BC 177

2

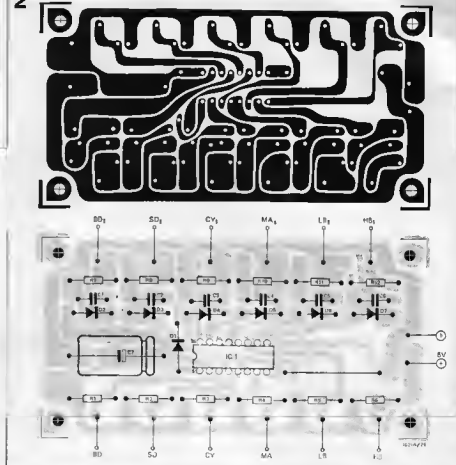

3

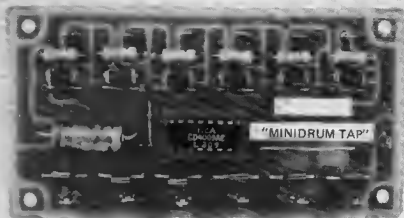

1621/3E

Figure 1. The circuit of the complete Mini-drum TAP.

Figure 2. The p.c. board and component layout for the complete TAP with six inputs.

Figure 3. Photograph of the completed TAP board.

Table 3.

Components for specific gyrator instruments.

	C ₁ /C ₂	C ₃	C ₄	C ₅	C ₆	C ₇	C ₈	C ₉	R ₉	R ₁₀	R ₁₁	R ₂₂	R ₂₃	D ₄
Basdrum	150n	10n	33n	27n	1 μ	330n	1 μ	100n	27k	4M7	4k7	27k	470k	-
Snaedrums	18n	x	10n	10n	56n	150n	100n	x	100k	4M7	100k	470k	470k	-
Low Conga	100n	68n	22n	15n	82n	82n	15n	100n	22k	4M7	33k	8k2	8k2	-
High Conga	47n	x	22n	2n7	27n	68n	22n	x	39k	4M7	10k	6k8	x	-
Rimshot	47n	1n8	5n6	4n7	10n	2n7	2n7	x	82k	4M7	22k	-	x	DUS
Wood Blocks	47n	1n	1n8	1n	8n2	10n	1n	x	39k	4M7	47k	-	x	DUS
Low Bongo	100n	x	x	22n	390n	33n	100n	27n	82k	4M7	-	100k	x	-
High Bongo	100n	x	x	22n	120n	27n	100n	27n	82k	4M7	-	100k	x	-

X = omit

- = wire link

supply is not required, although some form of simple stabilizer is desirable.

The Minidrum TAP p.c. board

Figure 2 is the p.c. board and component layout for the TAP circuit of figure 1. It is recommended that a socket be used for the IC to avoid the possibility of damage due to static or leakage from unearthed soldering irons. A photograph of the completed board is given in figure 3.

The instruments

All the percussion instruments use the gyrator board described in last month's issue, the circuit of which is given in figure 4, but with component values to suit the different types of instrument. Table 2 gives the component values which are common to all the gyrator boards, while table 3 gives the components which determine the characteristics of the individual instruments. The gyrator p.c. board and component layouts are given in figures 5-13.

Each percussion instrument has two inputs, input 1 and input 2. A monostable multivibrator (one-shot) is connected to each of these inputs and these one-shots drive the gyrator. The output from the TAP is used to drive input 1 while input 2 may be driven by the ruffle system if desired. If ruffle is not required on a particular instrument then the monostable on input 2 may be omitted, as in last month's article.

As described in last month's article, the snaredrum has filtered noise mixed in with the output of the gyrator. The cymbal, brushes and maracas are merely filtered noise, with no gyrator input. The p.c. board given in the previous issue is used for the noise generator and noise gating. If an instrument is to be used with the ruffle system (the snaredrum for example) then both gating inputs of the snaredrum noise board are used, one for the manual input and one for the ruffle input. In the case of the snaredrum these inputs are driven by the one-shots on the gyrator board and thus the one-shots on the noise board may be omitted (figure 15). In the case of purely noise instruments (cymbal, brushes and maracas) the manual TAP drives the noise board directly and the one-shot(s) must be used (figure 14).

If the ruffle system is not used then one noise board will do for two instruments, as was the case in last month's article where snaredrum and cymbal noise were produced by the same board. The board and component layouts are given in figures 16-20. The component values for the maracas and cymbal noise boards are given in tables 4 and 5, those of the snaredrum noise board in table 6. R_X is added in the circuit for the brushes. To mount this resistor on the p.c.b., the connection $R_{64} - C_{25}$ is left 'in the air', and R_X is connected between this junction and the original connection to T_{18} (see figure 19).

The automatic bassdrum

Figure 21 is the circuit of the pulse

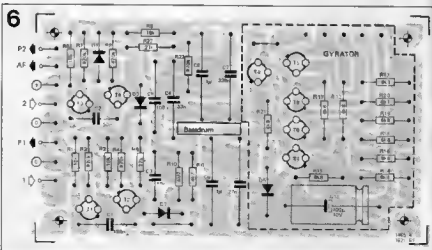
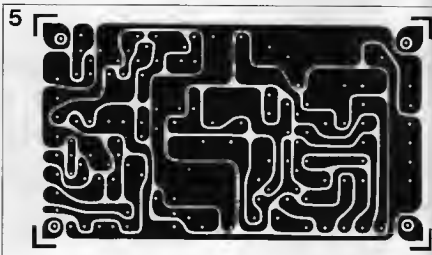
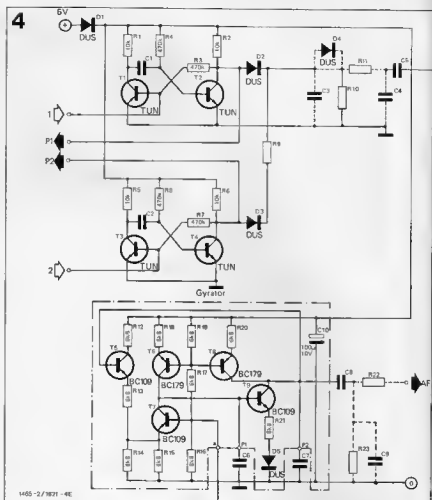

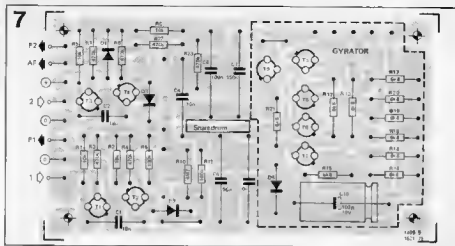
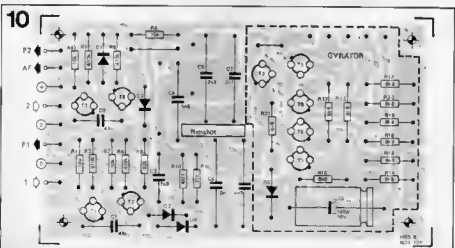
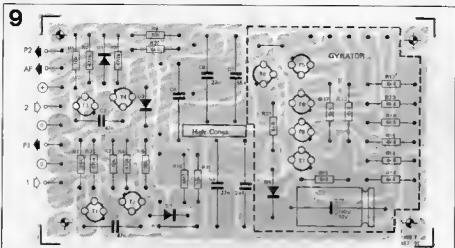
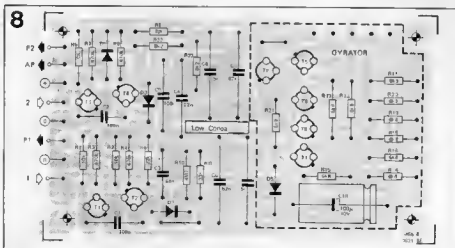

Figure 4. Circuit of the complete gyrator board with two input monostables. The component values are listed in table 3.

Figure 5. The gyrator p.c. board.

Figures 6-13. Component layouts for all the gyrator instruments listed in table 3.



generator for the automatic bassdrum. The circuit is designed around an RCA COSMOS IC, the CD4011AE, which is a quadruple two-input NAND gate.

Gates N_1 and N_3 form an astable multivibrator. Pulses from the output of N_1 are inverted and squared by T_1 . C_4 and R_5 differentiate these pulses and D_2 clamps the output so that only positive going pulses appear at the cathode of D_3 . These pulses may be used to trigger any of the instruments, but in the system described here they are used to drive only the bassdrum. The tempo of the bassdrum may be adjusted from about 40 to 240 beats per minute by means of P_1 .

In passing it may be noted that the circuit of figure 4 may be used on its own as a metronome, by reducing R_3 to 15 k, R_4 to 1 k and R_5 to 4k7. C_4 is increased to 100 n and D_3 is replaced by a 47 Ω resistor. The circuit will then drive a small loudspeaker directly, and may be used as a self-contained unit with a battery since power consumption is quite low.

Instead of a mechanical start/stop switch the automatic bassdrum of course uses a TAP. N_3 and N_4 are connected as a set-reset flip-flop; touching the start contact sets the flip-flop and touching the stop contact resets it. In the reset (stop) condition the output of N_3 holds the inputs of N_2 high via D_1 and the astable will not start. In the set (start) condition the output of N_3 is low and D_1 is reverse biased, so the astable runs. The circuit is so designed that as soon as the button is touched the circuit produces its first output pulse, even at low repetition rates. When the stop button is touched the circuit stops immediately.

Figures 22 and 23 give the p.c. board and component layout for the bassdrum pulse generator. Again it is recommended that a socket be used for the IC. Figure 24 shows a photograph of the completed board.

The ruffe system

The circuit of the complete ruffe

Figure 14. Noise circuitry for the Cymbal, Meracass and Brushes. See table 5 for the values of the unmarked components.

Figure 15. Snaredrum noise circuit. Note the absence of input monostables.

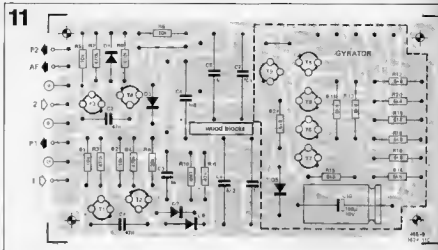

Table 4.

Components list for Cymbal, Meracass and Brushes, (figures 14 and 17-18) for components common to all boards. Where values differ see table 5.

Resistors:

R42, R53, R56, R60, R70, R75 = 10 k
 R44, R45, R49, R63, R65, R73 = 470 k
 R49, R66 = 6k8
 R50, R67 = 330 k
 R52, R69 = 5k6
 R55, R72 = 27 k
 R56, R76 = 100 k
 R74, R77 = 270 k
 R68 = 4k7
 P2 = 10 k preset

Capacitors:

C16 = 100 µ/10 V

Semiconductors:

T12, T13, T16, T17, T18,
 T21, T22, T23 = TUN
 T14, T15, T19 = TUP
 D7, D9, D10, D12,
 D13, D14 = DUS

Table 5.

Components list for Cymbal, Meracass and Brushes, for components unique to one particular instrument.

	Cymbal	Meracass	Brushes
R43, R61	10 k	10 k	2k7
R46	27 k	10 k	180 k
R47, R64	820 k	220 k	820 k
R50a, R67a	10 M	10 M	—
R51, R68	220 k	270 k	220 k
R54	100 k	8k2	10 k
R62	470 k	470 k	270 k
R71	100 k	8k2	100 k
Rx	—	—	180 k
C17	150 n	100 n	100 n
C18	66 n	720 n	39 n
C19, C26	12 n	100 p	47 n
C20, C27	100 n	12 n	x
C21	4n7	680 p	680 p
C22	68 n	470 p	390 p
C23	4n7	470 p	390 p
C24	150 n	100 n	1 µ
C25	68 n	120 n	180 n
C28	4n7	680 p	100 p
C29, C30	100 p	680 p	100 p
C31, C32	10 n	10 n	2n7
D8, D11	DUS	DUS	—

x = omit
 — = wire link

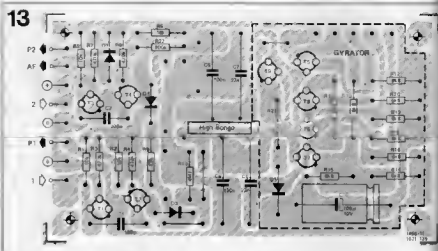
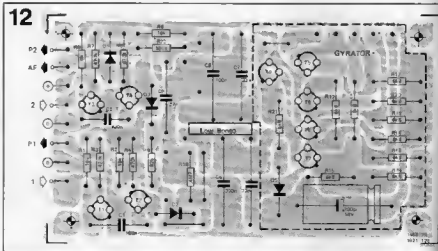

Table 6.

Components list for the snaredrum noise board (figures 15 and 20).

Resistors:

R78, R81 = 820 k
 R79, R92, R99 = 470 k
 R90, R93 = 6k8
 R81, R94 = 680 k
 R81a, R94a = 10 M
 R82, R95 = 100 k
 R93, R96 = 5k6
 R94, R88, R97, R101 = 10 k
 R85, R99 = 15 k
 R88 = 4k7
 R97, R102 = 100 k
 R99 = 4k7

R90 = 39 k

R100, R103 = 270 k

P3 = 10 k, preset

Capacitors:

C33 = 100 µ, 10 V
 C34, C39 = 8n2
 C35, C40 = 22 n
 C36, C37, C41, C42 = 2n7
 C38 = 1n2
 C43, C44 = 10 n

Semiconductors:

D15, D16, D17, D18, D19,
 D20, D21, D22 = DUS
 T24, T25, T27, T28 = TUP
 T26, T29, T30, T31 = TUN

14

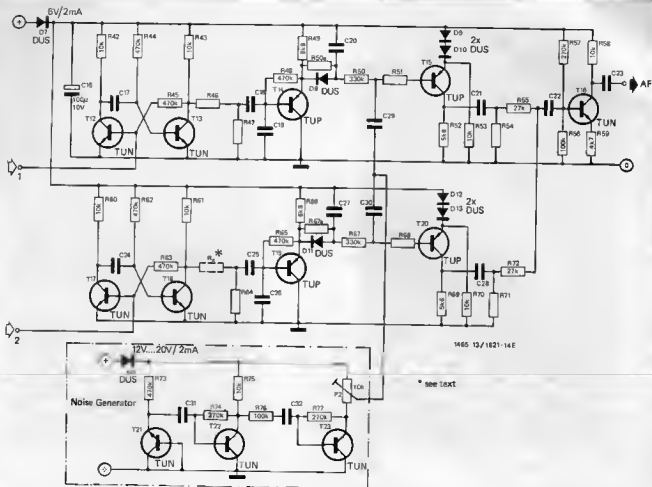

15

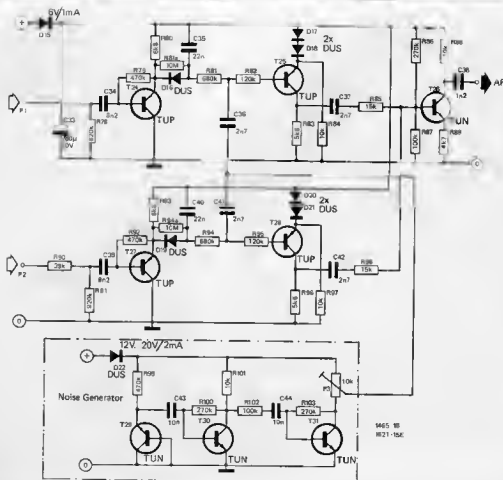

16

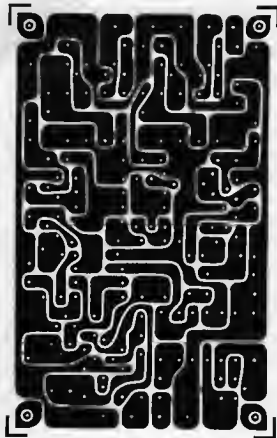

17

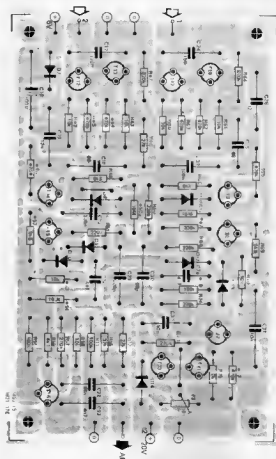

18

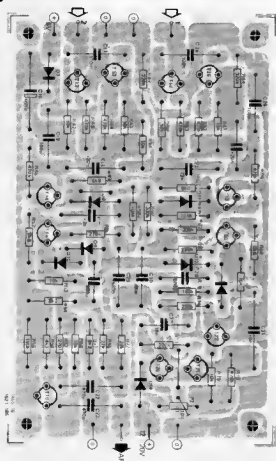

19

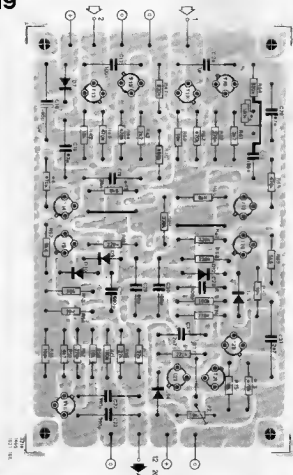

20

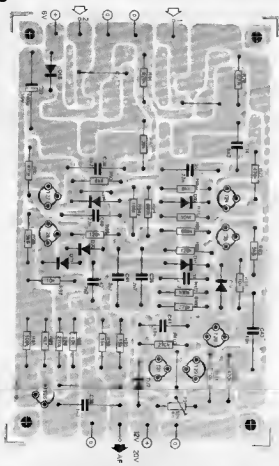

22

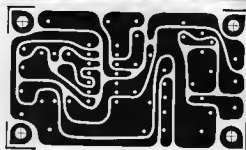

23

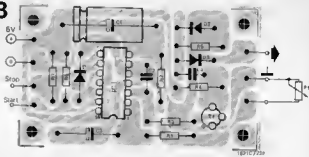

Table 7.

Components list
for figures 21 and 23.

Semiconductors:

IC = CD4011AE
T₁ = TUN
D₁ = BAY 61, BA 220
D₂, D₃ = DUS

Resistors:

R₁ = 100 k
R₂ = 10 M
R₃ = 47 k
R₄ = 4k7
R₅ = 27 k
R₆, R₇ = 27 M or 10 M
P₁ = 1 M, lin.

Capacitors:

C₁ = 100 μ, 10 V
C₂ = 27 n
C₃ = 2L2, 10 V
C₄ = 2n7

21

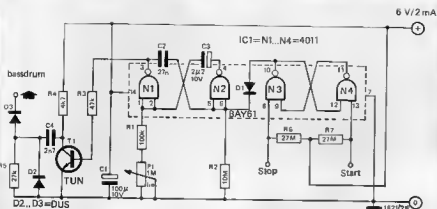

24

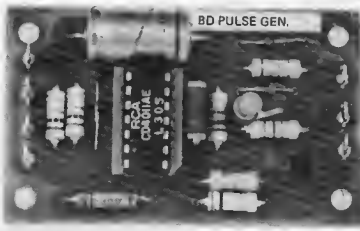

Figure 16. Noise p.c. board.

Figures 17-19. Component layouts for Cymbal, Maracas and Brushes respectively.

Figure 20. Component layout for snedrum noise board.

Figure 21. The automatic bassdrum pulse generator.

Figures 22 and 23. The board and component layout for the bassdrum pulse generator.

Figure 24. The completed bassdrum pulse generator board.

system is given in figure 25. The system is very similar in operation to the automatic bassdrum. I₁ and I₂ form an astable multivibrator and I₃ serves to buffer the output and improve the waveshape of the astable. I₄-I₆ form the TAP control for the ruffle system. As the three channels are identical only one will be described.

When the touch contact is not being touched the input of I₄ is held low via R₄. The output is therefore high. C₄ is charged via R₃ and current flows into the base of T₂ via D₂ and R₁₂. T₂ is driven into saturation so that the ruffle signal appearing via D₆ is blocked. When the contact is touched the output of I₄ switches at 50 Hz between '0' and '1'

25

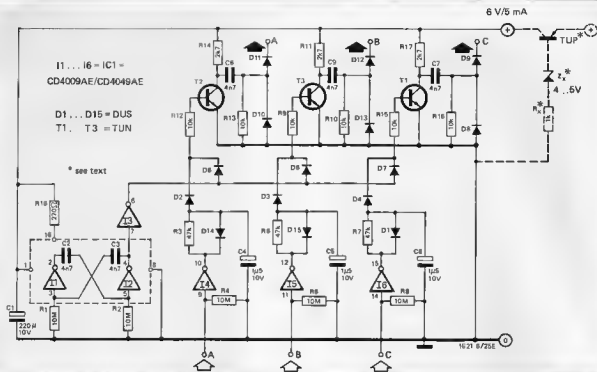

26

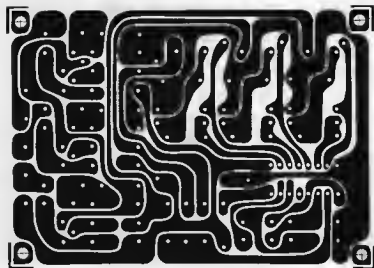

27

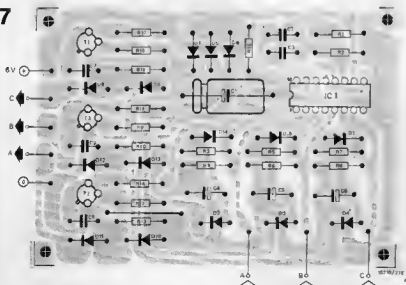

and C_4 discharges rapidly via D_{14} in the output stage of I_4 . T_2 may now be switched by the astable and the ruffe signal appears on the collector. This is differentiated and clamped by C_8 , R_{10} , D_{10} and D_{11} as in the bassdrum pulse generator.

A point to note with the ruffe system is that if a stabilized supply with a slow turn-on is used then the astable may fail to start due to insufficient coupling through C_2 and C_3 during this period. In that case the astable will be 'latched up' with both inverter inputs held high by R_1 and R_2 . This effect may be cured by placing the extra circuit, dotted in figure 25, in series with the supply to the board. The zener voltage should be approx. 4.5 V.

The printed circuit for the ruffe system is given in figure 26 and the associated component layout in figure 27. As can be seen from the diagram the inputs are located along the front edge of the board and the outputs and supply connections down the left-hand edge. Figure 28 is a photograph of the completed board.

Combinations of instruments

The combination of instruments used in the Minidrum is a question of personal taste and there are no hard and fast rules. There is plenty of room for experimentation. All the instruments described could be used, in which case two TAP boards would be required, the system might simply be extended to six instruments from last month's basic Minidrum. The example given in figure 31 uses 6 instruments, namely the bassdrum, snaredrum and cymbals of the basic Minidrum plus bongos and Maracas. A ruffe system is provided for the snaredrum and the automatic bassdrum is included. A list of

Table 8.

Components list
for figures 25 and 27.

Resistors:

$R_1, R_2, R_4, R_6, R_8 = 10 \text{ M}$
 $R_3, R_5, R_7 = 47 \text{ k}$
 $R_9, R_{10}, R_{12}, R_{13}, R_{15}, R_{16} = 10 \text{ k}$
 $R_{11}, R_{14}, R_{17} = 2 \text{ k}$
 $R_{18} = 270 \Omega$

Capacitors:

$C_1 = 220 \mu/10 \text{ V}$
 $C_2, C_3, C_7, C_8, C_9 = 4 \text{ nF}$
 $C_4, C_5, C_6 = 1 \mu 5/10 \text{ V } (2 \mu 2/10 \text{ V})$

Semiconductors:

IC = CD 4009 AE or CD 4049 AE
 $T_1 \dots T_3 = \text{TUN}$
 $D_1 \dots D_5 = \text{DUS}$
 $Z_x = \text{Z-Diode (see text)}$

Table 9.

Input resistors for mixer preamp
(figures 29 and 30).

bassdrum	: 27 k
snaredrum	: 470 k
low conga	: 100 k
high conga	: 100 k
low bongo	: 1M5
high bongo	: 1M5
rimshot	: 560 k
wood blocks	: 82 k
maracas	: 390 k
cymbal	: 1M2
brushes	: 470 k
snaredrum noise	: 270 k

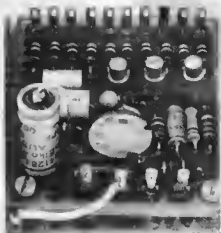

Figure 25. Circuit of the three-channel ruffe system.

Figures 26 and 27. The p.c. board and component layout for the ruffe system.

Figure 28. The completed ruffe board.

Figure 29. Circuit of the mixer-preamplifier.

Figure 30. Board and component layout for the mixer-preamplifier.

28



29

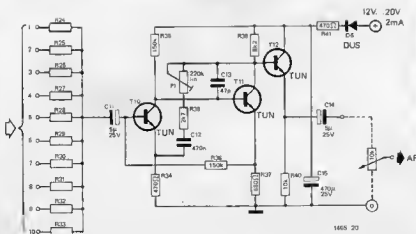

30

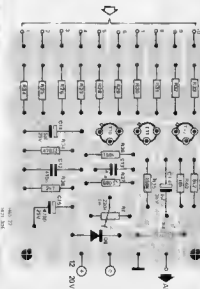
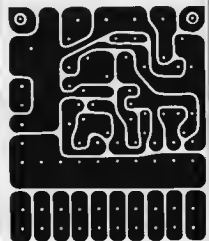

31

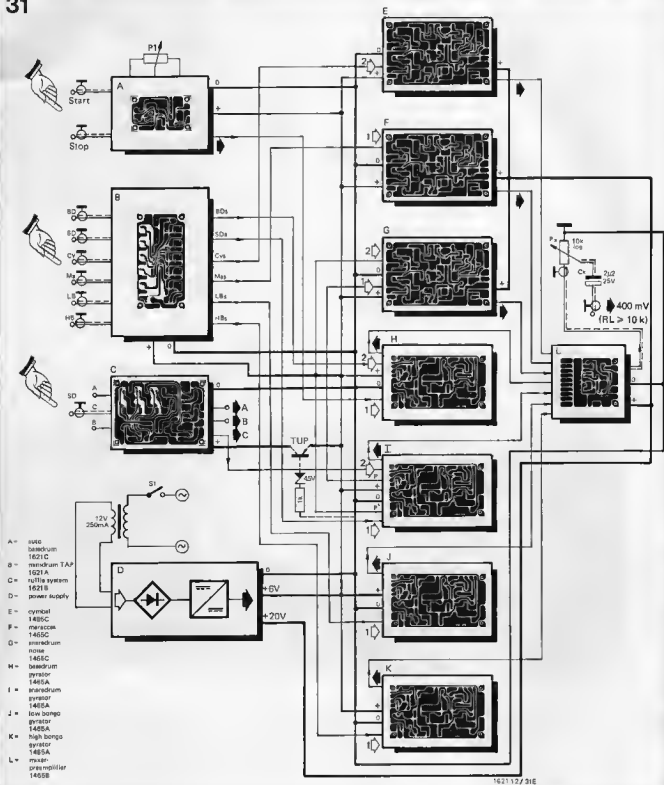

boards given in this example is given at the side of the figure.

It should be stressed again that this is only an example and that any combination of instruments may be used to suit personal taste. All that is required is a little common sense and application of a few simple rules. When choosing the combination of instruments the following points should be noted.

1. For each gyrotor instrument one gyrotor board is required.
2. For the noise instruments (maracas, brushes and cymbal) one board will do

for two instruments, unless ruffle is required, in which case one board is required per instrument. If ruffle is not used then the input monostables are included on the board and the instruments are driven direct from the TAP. If ruffle is used then the monostable on the input driven from the ruffle board is omitted.

3. In the case of the snaredrum, if ruffle is used then one noise board is required for this instrument, both input monostables being omitted and the inputs driven from the ruffle board

Figure 31. Example of a complete drumkit system with four gyrotor instruments and two noise instruments.

Figures 32 and 33. Photographs of a comprehensive manual drumkit using all instruments except brushes.

and the P' output of the snaredrum gyrotator board respectively. If ruffle is not used the snaredrum noise board will accommodate another noise instrument as in the basic Minidrum described last month.

Construction

The main constructional point to watch is that it is essential to ensure that all boards function before commencing final assembly. Readers' enquiries show that the most common cause of failure of a project is incorrect assembly of boards. Another point to remember is that supply and earth loops should be avoided in the wiring as these can give rise to hum.

A typical example of construction is given in figures 32 and 33. This instrument was built by Elektor laboratories for exhibition purposes and 9 of the instruments described were included. Brushes were the only instrument omitted. Of course for a practical Minidrum the case should be made of metal rather

Table 10.

Components list for figures 29 and 30.

Resistors:

R34, R41 = 470 Ω

R35, R36 = 150 k

R37 = 680 Ω

R38 = 2k7

R39 = 6k2

R40 = 10 k

P1 = 200 k, preset

R24... R33 see table 9

Capacitors:

C11, C14 = 5 μ /25 V

C12 = 470 n

C13 = 47 p

C15 = 470 μ /25 V

Semiconductors:

D6 = DUS

T10, T11, T12 = TUN

32

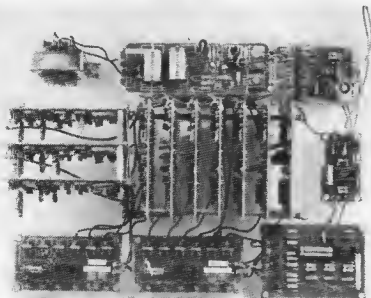

33

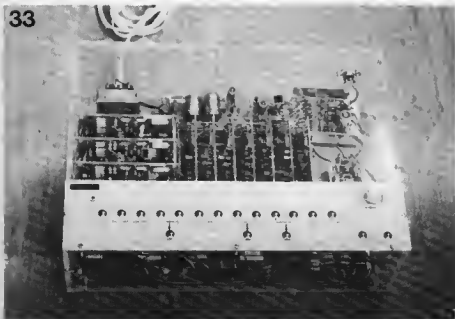

than clear Perspex as this will afford some electrical screening.

In figure 32 three noise boards for the cymbal, maracas and snaredrum are on the left. To the right of them are seven gyrotator boards and on the extreme right the auto bassdrum. Along the bottom of the photograph are the two TAP boards and the ruffle board. The mixer-preamplifier described in last month's article is at the top right-hand corner. The circuit and board layout are given in figures 29 and 30.

The mains transformer should be mounted well away from the TAP and ruffle boards and the mixer-preamplifier to avoid hum pick-up. Note that 9 channels of the TAP or 1½ boards are used in this example.

M

The Minidrum will be on display (and working) together with many other Elektor projects at the 1975 London Electronic Components Show at Olympia, May 13-16.



compressor

Compressors are now being used on an ever-increasing scale. They may be found in tape recorders, intercom systems and baby alarms, public address systems, discotheques and of course broadcast transmitters. A compressor supplements a manual volume control and allows a system to adjust itself to a wide range of input signals with little distortion.

The design described here should find a wide range of applications with the electronics enthusiast.

The aim of compression

Where signals with a wide dynamic range have to be processed it is desirable that as little distortion as possible should occur. The designer of, say, a public address system may have given much thought to achieving a good distortion figure, but this is of no avail if the system is overloaded by an enthusiastic speaker shouting into the microphone. It is of course possible to prevent a circuit from being overloaded by attenuating the input signal with a fixed or manually variable attenuator, but then in the example above the person who mumbles into his notes would certainly not be heard.

This is where a dynamic range compressor comes in. A compressor is basically an attenuator, or variable gain amplifier, which is controlled by the signal it is attenuating, either directly or by a control voltage derived from the signal. As the signal increases so does the degree of attenuation, so the compressor tries to keep the output signal

constant whatever the input. This cannot be achieved in practice, but it is possible to limit the output to a narrow range over a wide range of input signals. In a p.a. system (figure 1) a compressor could be included between the microphone preamp and the normal volume control. The compressor, like death, is a great leveller.

Compressor Transfer Functions

At first sight it would seem to be an admirable aim to control the output signal amplitude with the input signal as in figure 2. This system has an overall gain of $\frac{K}{V_i}$, where K is a constant and V_i is the input voltage (for an attenuator of course the gain is less than 1).

$$\text{So } V_o = \frac{V_i K}{V_i} = K.$$

The output voltage is therefore constant for all input voltages. This seems admirable until one considers what happens

Figure 1. Block diagram of a p.a. system including a compressor.

Figure 2. A first approach to a transfer function for a compressor. This is doomed to failure however.

Figure 3. Black-box representation of a square-law compressor.

Figure 4. a. Voltage-current curve of a filament lamp. The resistance increases with increased current.

b. Compressor using a lamp and a fixed resistor.

c. Transfer function of the compressor.

Figure 5. a. Voltage-current curve of a VOR. b. Compressor using a VOR and a fixed resistor. c. Transfer function of the compressor.

Figure 6. Dynamic characteristics of various types of compressor in response to a sudden burst of signal.

Figure 7. Block diagram of an active compressor using a peak detector to derive a control voltage which alters the attenuator.

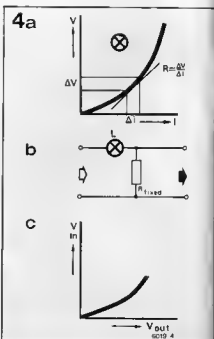
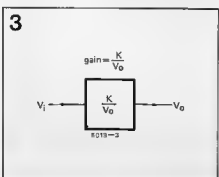
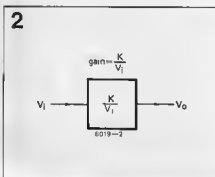
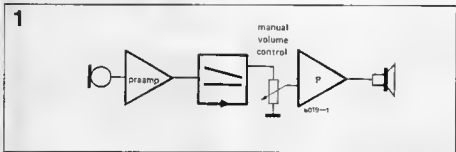

when v_i is zero. The gain then becomes infinite and this idea becomes unattractive.

A much better solution is to control the output signal with the output signal, which at first sight may seem odd. In figure 3 however it can be seen that the gain is $\frac{K}{V_o}$.

$$\text{Therefore } v_o = \frac{K v_i}{V_o}$$

or

$$V_o = K v_i$$

This is a square-law compressor function. Of course, other functions may be achieved, notably logarithmic, where $v_o = K \log v_i$.

Practical Compressor Circuits

There are many different kinds of compressor circuit. One of the oldest and simplest circuits makes use of the non-linear resistance of an incandescent lamp, whose resistance increases as the current through the filament increases. In figure 4 the resistance of the lamp, which forms the upper limb of the attenuator, is low at low signal levels so only a small portion of the signal voltage is dropped across it. At higher signal levels the resistance increases and a larger proportion of the signal voltage is dropped across the lamp. The output signal therefore does not increase as much as it would with a normal attenuator. The thermal inertia of the lamp filament means that this circuit cannot follow the actual signal waveform but only the envelope (provided the frequency is not too low) so distortion produced by the circuit is fairly small. The thermal inertia of the filament means, however, that the circuit cannot respond quickly to sudden increases in signal, so that associated circuitry may be overloaded whilst the lamp resistance is changing. Also the range of this type of compressor is limited.

An alternative solution would seem to be the use of a voltage-dependent

resistor (VDR) as in figure 5. This has a voltage versus current curve which is approximately the inverse of that of the lamp, so it is included in the lower limb of the attenuator. As the signal is increased the resistance of the VDR decreases so a smaller proportion of the signal appears across it. The response time of a VDR is quite fast so that it will follow sudden increases in signal amplitude, but unfortunately it can also follow the signal waveform so that instead of compressing the envelope amplitude whilst preserving the wave-shape it simply 'rounds off' the signal peaks thus introducing distortion. Nonetheless, in certain applications where distortion can be tolerated, such as amateur radio transmitters or intercoms, it does have its uses.

It thus appears that the compressor designer is caught between two stools. A slow-acting device will cause little

distortion on sustained large signals, but will not react sufficiently quickly to prevent momentary overloads of the equipment, whereas a fast-acting compressor will react in time to prevent overload, but will of itself introduce distortion. Here, however, an unusual aural phenomenon comes to the designer's aid. The ear is incapable of detecting even large amounts of distortion in transients, so that if a fast-acting compressor is applied to a sudden increase in signal it will prevent gross overloading of the system whilst the distortion it introduces will be unnoticed. Once the compressor has limited the signal, however, the ear can detect the distortion it introduces, so on sustained loud passages the slow response of the lamp-type compressor is required. In fact what is required is a compressor with a fast attack and slow decay characteristic.

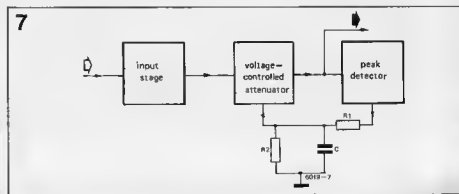
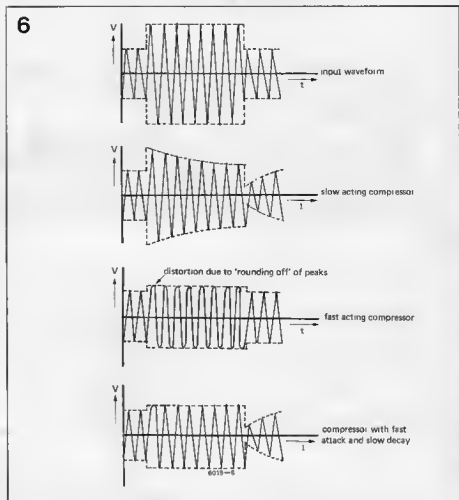
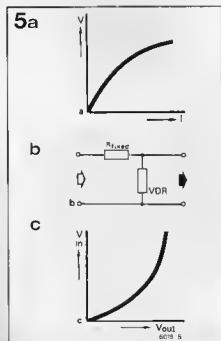

The characteristics of various types of compressor are given in figure 6. The triangular waveform was used to show how distortion is caused by a fast-acting compressor.

The discussion has so far been confined to passive devices that are controlled

directly by the signal on which they operate, but for a device with different attack and decay time constants it is necessary to turn to active circuits. In figure 7 the signal passes through the input stage and into a voltage-controlled attenuator. The output voltage is taken

Figure 6. An LDR in a voltage-controlled attenuator. This circuit suffers from slow response due to the inertia of the lamp and LDR.

Figure 9. An r.f. carrier type of compressor. The filter eliminates harmonic distortion of the carrier caused by the attenuator and also eliminates control-voltage noise.

Figure 10. Voltage-current curve of a diode and circuit of a simple diode attenuator.

Figure 11. Balanced type of diode attenuator eliminates control-voltage noise which appears in common mode.

Figure 12. The circuit of the final compressor design.

Figure 13. The printed circuit board and component layout of the compressor.

parts list:

resistors 1/4 Watt:

R₁, R₄, R₁₀, R₁₂ = 10 kR₂, R₉, R₂₁, R₂₂ = 220 kR₃ = 4k7R₅ = 220 ΩR₆, R₁₇, R₂₀, R₂₆ = 22 kR₇ = 1 kR₈, R₁₅, R₁₆ = 330 kR₁₁ = 270 kR₁₃, R₁₄, R₂₅ = 3k3R₂₄ = 47 kR₂₇ = 120 kP₁ = preset 22 k

transistors:

T₁, T₃ to T₉ = 6C 109CT₂ = 6C 179C

capacitors:

C₁ = 100 nC₂, C₁₁ = 1 μ, 10 VC₃ = 180 pC₄ = 100 μ, 16 VC₅, C₉, C₁₀ = 560 nC₆ = 100 μ, 4 VC₇, C₈ = 2.2 μ, 10 VC₁₂, C₁₃ = 47 μ, 10 VD₁ = zener diode 2,7 VD₂ to D₅ = germanium diode

matched pairs AA 119

D₆ to D₈ = silicon diode 1N914

or 1N4148

for V_b = 9 Volt: R₁₈, R₁₉ = 270 Ωand R₂₃ = 1k5for V_b = 12 Volt: R₁₈, R₁₉ = 330 Ωand R₂₃ = 1k5

8

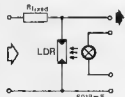

9

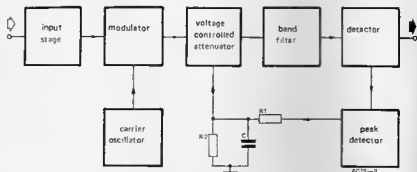

10

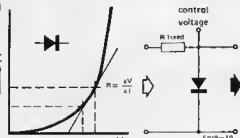

11

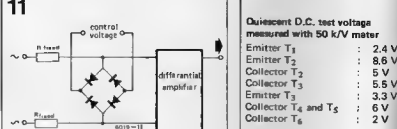

Quiescent D.C. test voltage
measured with 50 k/V meter

Emitter T ₁	: 2.4 V
Emitter T ₂	: 8.6 V
Collector T ₂	: 5 V
Collector T ₃	: 5.5 V
Emitter T ₃	: 3.3 V
Collector T ₄ and T ₅	: 6 V
Collector T ₆	: 2 V

12

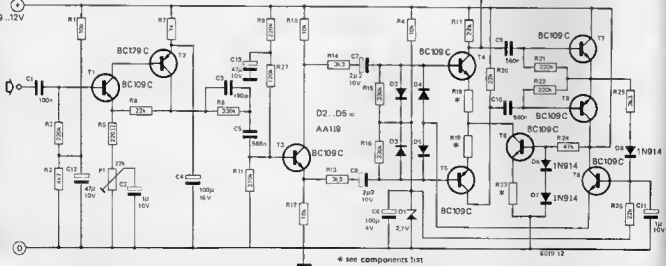

from the output of the attenuator and is also fed to a peak detector which rectifies the signal. The rectified voltage charges up the capacitor C via the potential divider consisting of R_1 and R_2 . The time constant is $\frac{(R_1 + R_2)C}{R_1 R_2}$.

The voltage on C increases the attenuation of the voltage-controlled attenuator as the signal increases. If R_1 is small C charges up quickly but since the discharge path for C is via R_2 only, the decay time constant can be made as large as desired so that the voltage on C will not follow the signal waveform.

The voltage-controlled attenuator

Whilst the derivation of a control voltage from the signal is a relatively simple matter the design of a suitable voltage-controlled attenuator is another matter. Ideally the attenuator should be electrically isolated from the control voltage

as otherwise the variations in control voltage with varying signal levels will appear as spurious noise at the output. One way of achieving this would be by using a light-dependent resistor (LDR) as the lower limb of the attenuator, as in figure 8. This would be controlled by a lamp driven from the control voltage.

Unfortunately problems arise due to the slow response of both the lamp and the LDR. Another rather elegant solution is to amplitude-modulate the signal onto a carrier and to vary the modulation depth by a voltage-controlled amplifier stage (figure 9). The compressed modulated signal is then filtered to remove control voltage noise and distortion (mainly second harmonic) and is then demodulated, resulting in a 'clean' compressed signal. Intermodulation distortion can still occur, but this can be minimised by proper circuit design. The design chosen for the final circuit

to be described was a diode attenuator. In its simplest form (figure 10) it suffers from two disadvantages.

1. The signal voltage will itself vary the attenuation as with a VDR thus causing distortion.
2. The control voltage will appear at the output superimposed on the signal thus producing spurious noise.

The first problem may be overcome by making the signal small compared with the control voltage so that it has little effect. The second may be prevented by using a balanced attenuator of four diodes as in figure 11. The signal appears differentially at the input of the differential amplifier and is therefore amplified. The control voltage, however, appears in common mode and is therefore rejected.

The Final Circuit

Figure 12 shows the circuit of a simple

13

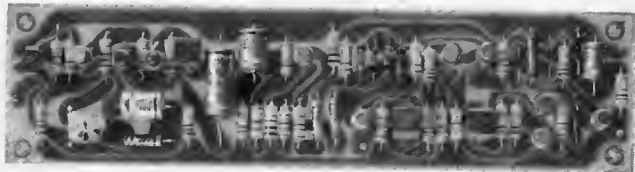
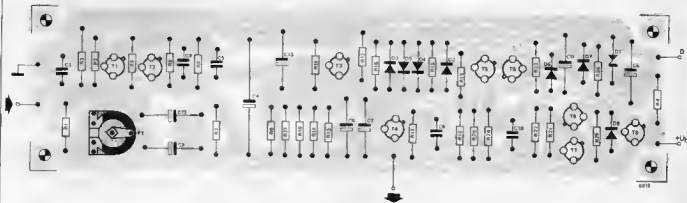

Compressor Specification

Input impedance	: 180 k
Output impedance	: 25 k (do not load with less than 100 k)
Gain with P_1 at minimum	: 60 (max. input voltage = 1 V)
Gain with P_1 at maximum	: 150 (max. input voltage = 30 mV)
Maximum (compressed) output voltage	: 500 mV
Maximum distortion (gain = 60)	
a. below compression threshold	: 0.4%
b. at maximum (1 V) input	: 5%
Maximum control current through diode bridge	: 350 μ A
Power consumption	: 10 mA at 9 V

compressor intended principally for speech applications. The circuit has an input stage with adjustable gain which is sensitive enough to be driven by a magnetic microphone. This is followed by a phase splitter which produces two antiphase signals to feed into the differential stage T_4 , T_5 . The compressed output is taken from the collector of T_4 which should not be loaded with anything less than 100 k as this would upset the circuit operation. A class B-type stage T_7 , T_8 drives the peak detector D_9 , C_{11} . The control voltage appearing on C_{11} is buffered by the emitter follower T_9 and is fed to the diode bridge D_2 ... D_5 . D_1 is a threshold control which determines the point at which compression starts. T_6 is simply a constant current source for the differential pair.

The board and component layout for the compressor are given in figure 13 and the performance figures in the table. At first sight it may seem that the distortion with the compressor operating is rather high but compared with the distortion when an amplifier is overloaded it is minimal.

Applications of the compressor

This compressor is sure to find a whole host of applications. It can be used to control the recording level in a tape recorder to prevent overloading of the tape. It can be used in amateur radio installations to achieve the largest possible modulation without over-modulating so that maximum range can be achieved. It can be used in a car radio so that quiet passages may be heard above the engine noise without loud passages being unbearable. The range of applications is limited only by the ingenuity of the constructor — remember, a compressor rules the waves (somewhat straighter than they were originally!).

To make optimum use of the possibilities for groove-modulation, gramophone records are cut with low audio frequencies attenuated and high audio frequencies boosted (with respect to 1 kHz). To simplify playback equalisation, a single weighting curve has been standardised throughout the world — the IEC disc-cutting characteristic. (This curve originated as the RIAA standard: Record Industry Association of America).

The disc-cutting engineer arranges for a '0 dB standard (reference) level' in the taped programme to produce a stylus tip-velocity about 14 dB below the 'safe' drive-level, to provide headroom for instantaneous signal peaks. 0 dB standard level (corresponding roughly to the average level in loud passages) is typically 39 mm/sec tip peak velocity at 1 kHz. Standard level on carrier-channel discs (CD4 and UD4) is lower, about 22 mm/s.

Experience indicates that wide-band cartridges suitable for carrier discs deliver 70 ... 140 μ V for each mm/sec of tip velocity. The usual 'hifi' cartridges deliver about 6 dB more. (Note that sensitivity specifications are usually given in RMS millivolts per peak centimetre per second). So the input to the preamplifier at standard level 1 kHz will be about 1 ... 10 mV peak.

What are the consequences of all this for the preamplifier?

Suppose it is the intention that the output voltage at standard level be about 100 mV RMS with the lowest-output cartridge. The closed-loop gain must therefore be 100 at 1 kHz. Now allow 20 dB of extra gain for IEC equalisation at the lowest frequencies, not including 20 dB of negative feedback (which should reasonably be maintained at the 'low end'). This tots up to an open-loop gain of at least 80 dB! Ten thousand times. That seems to eliminate the two-transistor configuration.

The SN 76131 integrated circuit, with the chosen lag compensation, has a typical open-loop response according to the upper dashed curve in figure 1. The

disc preamp

A preamplifier-equaliser for magnetic pickup cartridges has to meet quite exacting requirements.

Values for gain, noise level and maximum input voltage which will guarantee trouble-free operation under all conditions are not so easy to achieve. The well-known two-transistor configuration, operating from a 12 ... 18 V supply, invariably falls short on gain and overdrive-margin — unless it is designed for a low nominal output voltage (about 30 mV). An alternative approach is to make use of a good integrated amplifier. The design about to be described, which meets all the requirements, employs a SN 76131. An almost identical I.C. is the μ A 739.

Figure 1. The desired closed-loop gain curve follows the IEC (IRIAA) disc equalisation characteristic, with a mid-band gain (1 kHz) of 40 dB (heavy line). The open-loop gain must be at least 20 dB greater; the SN 76131, with the chosen lag compensation, provides this with a margin of about 10 dB (upper dashed curve).

Figure 2. The heavy line is an estimated contour for the highest voltage delivered to the preamplifier by a high-output dynamic cartridge. The preamplifier cannot be over-driven by the highest input voltage; the upper dashed line is the overdrive threshold for the disc-preamplifier with SN 76131. This clears the maximum-input contour by approximately 10 dB.

Figure 3. The maximum RMS output level produced by the preamp when used with a high-output cartridge follows the thick contour. The dashed line indicates the maximum output capability. The safety margin is here once again about 10 dB.

Bibliography:

- Electronic Engineering*, January 1973.
Radio Elektronika, January 1959.

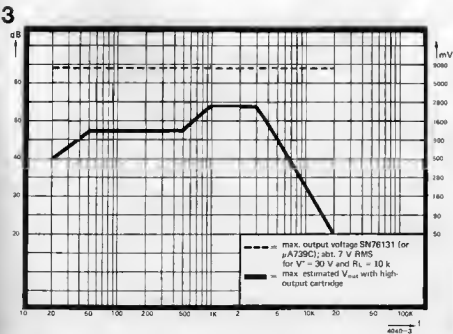
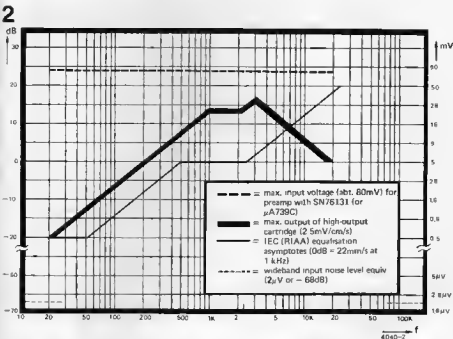
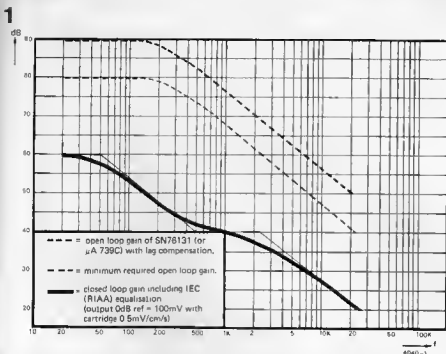

lower dashed curve indicates the minimum requirement (80 dB at the low end, reducing as the closed-loop gain - i.e. the bold line in figure 1 - falls according to the IEC curve). The conclusion is that there is about 10 dB of open-loop gain to spare at all frequencies, which will accommodate IC-tolerances etc.

Overdriving the input

To find the maximum input voltage which can occur, one must start with the highest-output cartridge. This will deliver, as shown earlier, about 5...10 mV peak at standard level.

The maximum level encountered on the disc is nominally +14 dB relative to standard level. This indicates a nominal maximum input voltage of 25...50 mV. (At 1 kHz of course). It is clearly advisable to regard this figure, with due respect, as nominal. One might encounter a cartridge with still higher output or some disc manufacturer may fully exploit tracing-compensation, to cut a clean signal at more than +14 dB... The absolute limit (set by 'slope-overload' at the inner radius of LP discs) is presently about 350 mm/s (+18 dB) - but a 33 disc also has outer grooves and they can be cut at a level 6 dB higher. This means that in theory the maximum output level for the highest output cartridge is about 200 mV! With the circuit arrangement given, the SN 76131 will accept 80 mV at the input (thick dashed line in figure 2).

The same figure can be used to estimate the effect of amplifier noise. The wideband noise level, referred to the SN 76131 input, is 2 μ V (RMS). This is -68 dB in the figure (0 dB = 5 mV RMS). For the least sensitive cartridge, this noise level is -54 dB relative to standard level for CD-4 or UD-4 discs. Assuming maximum signal level to be +14 dB the overall S/N ratio is (for this worst case) 68 dB. Manufacturers estimate that the S/N ratio possible with a first-rate LP pressing is about 70 dB. Conclusion: pass.

Figure 2 can be used once more to determine the hum-level requirements. The IEC bass-lift now aggravates matters: to achieve a hum level 60 dB below standard level, with a fairly high-output cartridge (5 mV RMS at 1 kHz), it becomes necessary to keep the hum voltage at the input below 1 μ V! This can be achieved, in general, by providing good screening for the input circuit and for the preamplifier itself (signal-return inside the cable-screen, the latter bonded to signal-earth at the amplifier end only), and by properly smoothing (preferably regulating) the DC supply. The sensitivity of the SN 76131 to interference on the DC supply rail is quoted - under operating conditions rather different to the above - as 50 μ V/V. (i.e. 50 μ V apparent input for each volt of supply disturbance). To achieve the 1 μ V hum level just mentioned means keeping supply ripple below 20 mV. A simple active circuit will readily meet this requirement;

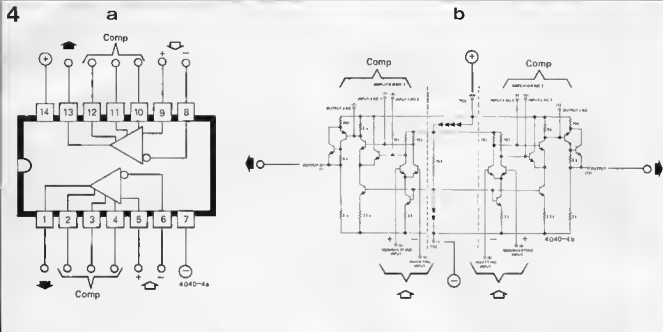

simple smoothing of a 'raw' DC supply would probably be inadequate or too expensive (or both!).

Clipping at the output

The requirement that the input circuit is not overdriven will not by itself guarantee that the amplifier as a whole operates within limits. The output circuit can still 'run out of' voltage or current swing.

Taking the combination of a sensitive cartridge and the maximum disc modulation likely to be encountered, one can estimate the highest level of output signal that the preamplifier will have to deliver. This can be done by combining the closed-loop gain characteristic (figure 1, thick line) with the maximum cartridge output contour (thick line in figure 2). The result is shown in figure 3 (thick line). The conclusion is that the

voltage swing at the output can be as high as 2.5 V RMS (7 V p-p).

The clipping level for the SN 76131 depends on the supply voltage and on the load impedance. The case of $V^+ = 30$ and $R_L = 10$ K, where the IC can deliver about 7 V RMS, is shown dashed in figure 3. This reserve should take care of all eventualities. If one considers a brink-of-disaster capability of 3 V RMS, then the combinations 18 V/5 K, 14 V/10 K and even $V^+ = 12$ (at $R_L = 50$ K) are in order. Even under these conditions, current clipping due to the load of the feedback network on the output (at the highest audio frequencies) and slow-rate limiting (due to the early open-loop rolloff) are not expected to occur.

Integrated circuit

The circuit was designed around the specified SN 76131 by Texas Instru-

Figure 4. The pinning of the IC: SN 76131, TBA 231, TCA 590C, μ A 739C and LM 1303 (figure 4a) is identical. The internal circuit diagram (figure 4b) however only applies to the SN 76131.

Figure 5. The circuit diagram of the equaliser-preamplifier. An integrated voltage regulator, when required, can be connected between the points A and B (see text).

Figure 6. PC board and component layout for the equaliser-preamplifier. All external connections are made to one edge of the PC board, so that it can be used as plug-in module in a complete control amplifier.

Figure 7. Illustration of the preamplifier board as plug-in module.

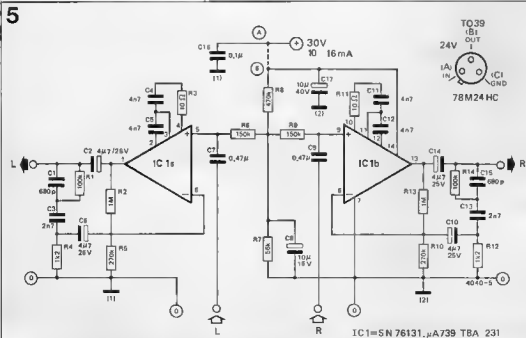

Parts list to figure 6.

Resistors:

$R_1, R_{14} = 100$ k
 $R_2, R_{13} = 1$ M
 $R_3, R_{11} = 10$ Ω
 $R_4, R_{12} = 1$ k2
 $R_5, R_{10} = 270$ k
 $R_6, R_9 = 150$ k
 $R_7 = 56$ k
 $R_8 = 470$ k

Capacitors:

$C_1, C_{15} = 680$ p
 $C_2, C_6, C_{10}, C_{14} = 4\mu$ F, 25 V
 $C_3, C_{13} = 2$ n7
 $C_4, C_5, C_{11}, C_{12} = 4$ n7
 $C_7, C_9 = 0.47$ μ
 $C_{16} = 0.1$ μ

Semiconductors:

IC1 = SN 76131, μ A 739C, TBA 231

IC1=SN 76131, μ A 739 TBA 231

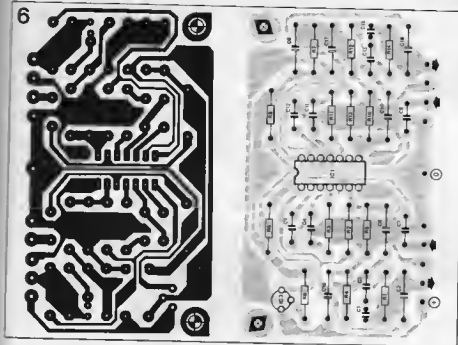

Table 1. The most important specifications of the SN 76131 and μ A 739C.

V^+ max.	36 V
V_{in} max.	± 5 V
P_{out} max.	500 mW
V_{out} swing	1...26 V*
Open loop gain typ	18000*
Open loop gain min	6500*
Z_{in} typ.	150 k Ω *
Z_{in} min.	37 k Ω *
Z_{out} (1 KHz)	5 k Ω *
Crosstalk (10 KHz)	-140 dB*

* These values apply for $V^+ = 30$ V;
 $R_L = 50$ k Ω

Table 2. Main specifications of the disc pre-amplifier described here.

Voltage gain, 1 KHz	40 dB
Equalisation IEC	± 1 dB
Max. input (RMS)	80 mV
Max. output (RMS)	7 V
Input noise level	2 μ V
S/N ratio	55...70 dB*
Crosstalk (1 KHz)	-80 dB
T.H.D.	$\leq 0.1\%$

* see text

ments. According to the maker's data sheets, the Fairchild μ A 739C and the SGS TBA 231 are almost identical and should perform well in the circuit. The three IC's are pin compatible (see figure 4a). Two other IC's with the same pinning are the Philips TCA 590 C and

the LM 1303 by National Semiconductors. This last device has lower specifications for gain, noise and drive level - it will probably work acceptably in the preamplifier, but we have not checked this.

The internal circuit of the SN 76131

(and the TBA 231) is given in figure 4b. Except for the output transistor, the μ A 739C is identical. Table 1 lists the most important characteristics of the device. The TCA 590C has an additional class B output stage, while the LM 1303 circuit dispenses with the stabilising diodes and with the current sinks for the second long-tail pairs.

The external circuit

Figure 5 gives the complete circuit diagram of the equaliser-preamplifier. The open-loop response is set up by $C_4/C_3/R_3$ and $C_{11}/C_{12}/R_{11}$; it follows the appropriate dashed curve in figure 1. The IEC correction networks are $R_1/R_2/R_4/C_1/C_3$ and $R_{12}/R_{13}/R_{14}/C_{13}/C_{15}$. R_5 and R_{10} take care of the DC biasing. With the values given, the correction obtained using 5% components is within 1 dB of the IEC (RIAA) standard.

The input blocking capacitors C_7 and C_9 should not be replaced by larger values or by electrolytics. This could lead to undesirable switch-on phenomena ('plop' or even momentary oscillation). The values given will not affect the bass response (which is 1 dB down at 20 Hz). It has already been pointed out that the supply ripple must be well filtered. A typical regulated supply will meet the requirements, but a 'raw' supply followed by resistor-electrolytic filter will usually cause too much hum. In this case one can use an IC voltage regulator which will deliver 24...30 V at 15 mA (or more), e.g. the Fairchild μ A 78M24HC. The printed circuit board (figure 6) has a position for this regulator. If such a device is not to be used, the points A and B should be bridged.

To simplify assembly, all external connections have been placed at one edge of the PC board, using standard grid-spacing. A control amplifier which will be published at a later date has a PC board designed to accommodate the disc preamplifier as a plug-in module (figure 7).

Table 2, in conclusion, summarises the most important specifications of the equaliser-preamplifier for disc records.

Lit.: Texas Instruments data sheets for SN 76131.

✻

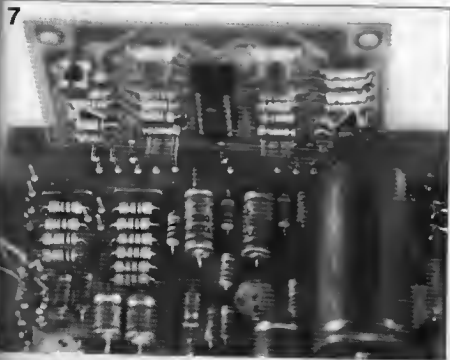

a/d converter

The necessity to convert a voltage to a frequency such that the frequency is accurately

proportional to the voltage is one which arises in many different electronic systems. Some digital voltmeters use this principle. The voltage to be measured is converted to a proportionate frequency, which is then measured by a conventional counter circuit, and the result

displayed digitally. In other cases, the requirement is to have a reading of a voltage existing some distance away. In this case the long cables, with their appreciable DC resistance, produce a voltage drop if any current is taken by the measuring instrument, and errors result. If however the information is carried over the cables as a frequency, although the amplitude may fall the frequency will not change. Increasing use of digital computers, digital logic IC's, digital displays, etc., produces many more applications.

A previous design for a converter circuit gave reasonable performance. However, further work produced several relatively minor changes which improved both linearity and temperature stability, resulting in the circuit described below.

It is relatively difficult to convert voltage to frequency in a direct manner, if good linearity is to be maintained. However, the reverse operation, frequency to voltage, is much easier. With this in mind, the method used here is firstly to convert voltage to frequency in a circuit which in isolation would not be very linear. The output frequency is however then converted back to voltage in another circuit

(which this time is highly linear) and the output voltage used in a negative feedback loop path so as to linearise the whole system. The overall linearity of the system will then approach that of the frequency-voltage converter, provided the feedback loop gain is high.

Figure 1 shows the block diagram. The high gain differential comparator (A) accepts the input voltage and compares

it with the feedback voltage. The voltage-frequency converter (B), which can be relatively non-linear, is driven from (A). Its output provides the system output, and also drives the highly linear frequency-voltage feedback stage (C).

The Basic Circuit

This circuit is shown in figure 2. An IC type 741 is used in conventional manner as the differential comparator. The system input voltage is applied to the non-inverting input pin 3, and the feedback voltage to pin 2. The output from pin 6 then regulates the frequency of the next stage in such a way that the two inputs remain almost identical. Capacitor C_1 provides AC negative feedback, to prevent appreciable AC signals appearing at pin 6.

The IC type 709, with the other components in the dotted line box (B) of figure 2, together form a square wave oscillator. Consider first the case when

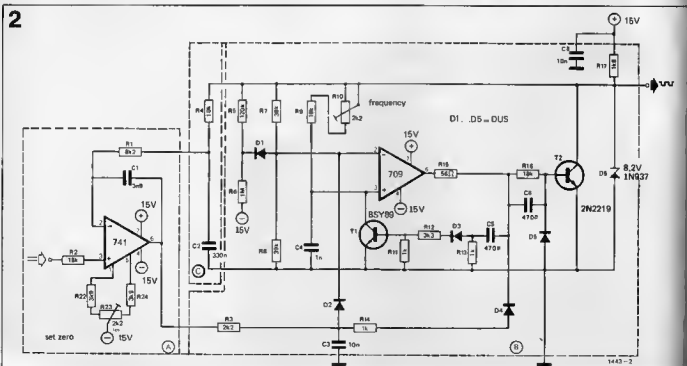
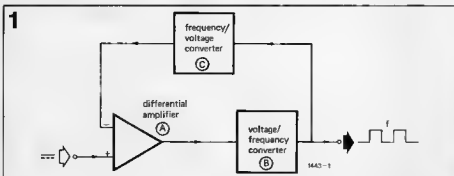
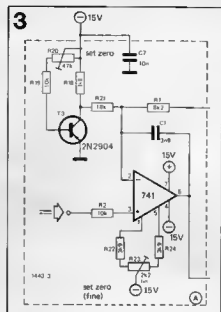

Figure 1. Block diagram of the complete system.

Figure 2. The basic circuit.

Figure 3. Showing extra transistor used to improve zero error.

Figure 4. The final circuit of the converter. The conversion factor is set by R_{10} .



positively via R_9 and R_{10} until pin 3 becomes more positive than pin 2, at which point the 709 output reverts, T_2 is once more turned on, and the cycle starts again with C_3 charging up. The result is a series of rectangular pulses at the output, whose width is t_1 and whose amplitude is constant (at the Zener voltage). Their PRF will however be determined by the time taken to charge C_3 , and hence by the 741 output voltage, so that overall the 741 input voltage controls frequency. D_3 is included to protect T_2 from excessive reverse voltage on its base. The circuit including T_1 , R_{11} , R_{12} , R_{13} , D_3 , and C_5 is put in to discharge C_4 to zero at the end of the period t_1 , and is driven by the positive-going step change from the 709 pin 6. The regenerative action, via T_2 , is speeded up by capacitor C_6 .

The frequency-voltage converter is surprisingly simple, comprising only R_4 and C_2 ! It merely smooths out the AC com-

ponent of the rectangular wave, leaving on C_2 the DC component, whose value is exactly proportional to the PRF, or frequency.

Improved Performance

It is a defect of the above system that the saturation voltage of T_2 (i.e. its collector-emitter voltage when turned hard on) is not exactly zero, but can be something around 40 mV. Worse still, this value varies with temperature. This has the effect of producing a zero error considered at the system input, so that with short circuit (i.e. zero) input the output frequency cannot always be set to zero by R_{23} .

This can be balanced out as shown in figure 3. An extra transistor T_3 is used, which is biased by R_{19} and R_{20} so that it is permanently in saturation. The degree of saturation is governed by R_{20} , and can be adjusted so that the saturation voltage equals that which occurs in T_2 . This voltage is applied to pin 2 of the 741, via R_{21} , and since the value of R_{21} almost equals the value of $(R_1 + R_4)$, the voltage at pin 2 is exactly zero when T_2 is saturated.

An extra spin-off from this arrangement is that temperature variations in the saturation voltages of T_2 and T_3 will approximately track each other, and so be balanced out.

This modification is shown in the revised circuit of figure 4, together with several other changes as follows:

- R_2 is reduced to 10 k.
- C_2 is increased to 1μ in order to improve accuracy for low input voltage levels, where frequency is of course low, and a longer time constant is desirable.
- C_4 is increased to 10 n, improving linearity at high input voltage levels.

there is a negative voltage on C_3 . Of the two differential inputs of the 709 (which is a differential amplifier), pin 2 will be more negative than pin 3, due to current in R_4 from the negative rail. The output at pin 6 will therefore be hard positive, holding T_2 in saturation. Provided the 741 output is sufficiently positive, C_3 will charge up via R_3 until it raises pin 2 of the 709 to slightly above pin 3. As soon as this happens, the 709 output pin 6 rapidly goes negative, thus cutting off T_2 and allowing the system output to rise to a voltage determined at about 8.2 V by D_6 . Immediately, the voltage pin 2 is drawn even more positive by current through R_7 . Thus the action is regenerative. This condition now remains for a time t_1 , which is determined by the values of R_7 , R_4 , R_3 , R_{10} , and C_4 . (The value of t_1 is not affected by the voltage on C_3 , because as soon as 709 pin 6 goes negative, C_3 is driven rapidly negative via R_{14} , D_4 , and R_{15} .) C_4 is charged

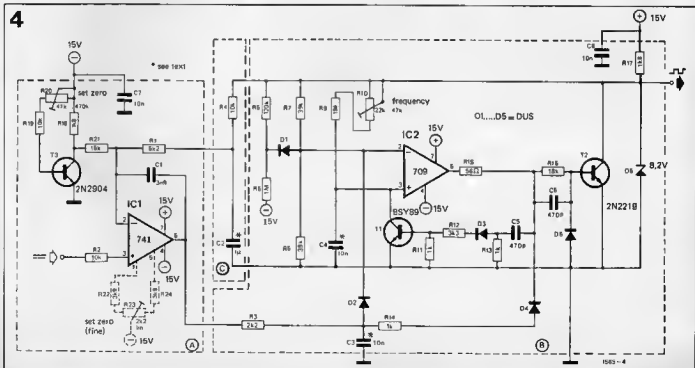

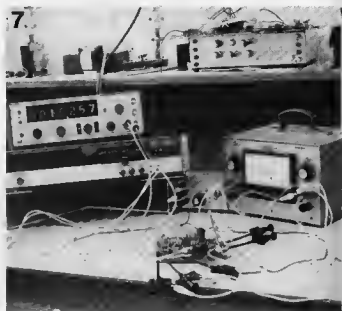
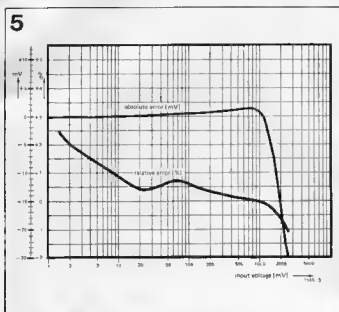
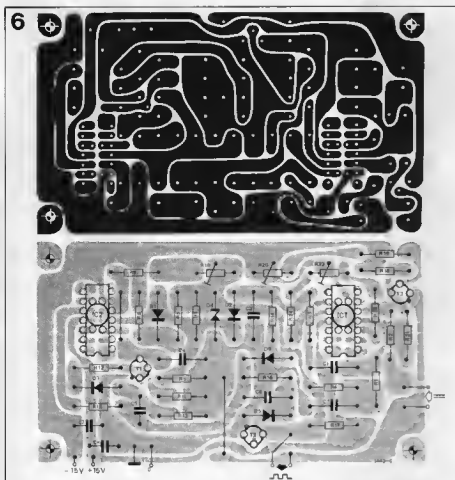

Figure 5. Test results.

Figure 6. PCB layout and component positions.



- (d) Trimmer R_{10} is increased to 22 k, so that despite the increased C_4 value, ratios of up to 10 KHz/V can still be set up.

Setting-up procedure

The sequence is as follows. The collectors of T_2 and T_3 , and also the voltage input, are temporarily shorted to earth. The zero offset pot R_{23} is then set to give zero volts at the 741 output. This adjustment is easier if a 100 k resistor is temporarily strapped across C_1 . The shorts across T_2 and T_3 , and the 100 k resistor can now be removed.

The pot R_{20} is set up for zero output voltage with zero input voltage. It should be remembered that since a negative frequency is meaningless (!) this setting should be approached by lowering the input voltage from positive towards zero, and observing the frequency to decrease and become zero simultaneously with input voltage. In some cases it may be necessary to alter the value of R_{19} , to compensate for unusual current gain values encountered in T_3 . In the same way, R_{20} can be increased to — say — 470 k.

The next stage is to set the voltage-frequency conversion factor. The short

Figure 7. Photograph of setting-up procedure. Here the DVM has accuracy better than 0.035%, and the frequency counter better than 0.01%.

circuit on the voltage input (obviously!) should be removed, and a source of exactly 1 V connected. To achieve the best accuracy of which the circuit is capable, this value should be set up with a digital voltmeter, or other instrument, having better than 0.1% accuracy. The output frequency can then be monitored on a counter and set up using the Pot R_{10} to the value desired. The design centre value for this circuit is 10 KHz/V, but of course other values can be set up if required.

Performance Details

Figure 5 gives graphs of the circuit performance after setting up as described above. The error in volts, over the whole input range 0.1 V to less than 1.5 mV. Further, the relative error over the range 7 mV to 2.5 V is less than 1% of reading. The circuit was also tested without R_{23} connected. With R_{20} it was set up with short circuit input to zero Hz, and then with R_{10} to give 10 KHz for 1 V input. It is to be expected in this case that both linearity and temperature stability would be worse. Despite this, the accuracy $\pm 1\%$ over the range 0.1-1 V was maintained.

Best temperature stability will be obtained by choosing C_2 , C_3 , and C_4 carefully, poly-carbonate types being recommended. (e.g. Siemens MKM). Linearity can be further improved by using a faster OP-AMP in place of the 709, or by replacing R_4 by a constant-current source. However, these sophistications are only worthwhile if really accurate test gear is available for setting up.

led displays

There are literally dozens of different seven-segment LED-displays currently available and it would be prohibitively expensive to specify and test every suitable alternative display for Elektor projects. This guide is intended to enable the

home constructor to choose such alternatives himself.

This guide is confined to displays with dual-in-line pin configuration and common-anode connection as this is the most popular format and these displays can be driven by the common 7447 TTL decoder driver or interfaced with MOS devices by single-transistor buffer stages. The guide is divided into three sections:

1. The chart proper.
2. Condensed data on the devices giving pin connections and important performance parameters.
3. Hints on choosing devices and calculating current limiting resistors etc.

In response to numerous requests from readers we publish this LED-display chart to enable constructors to find their way through the jungle of seven-segment display data and to choose alternative displays to those specified in Elektor projects.

The Display chart

This is used in a similar fashion to a mileage chart in a road atlas. The required device is first located in the diagonal list of type numbers (they run alphabetically by manufacturer, top left to bottom right). The proposed alternative is similarly located and if the box where the corresponding row and column cross contains a circle then the devices are direct replacements for each other. If the box contains a P they are pin compatible but the performance data should be checked to see if a substitution may be made. For instance, devices of different colours may be pin compatible.

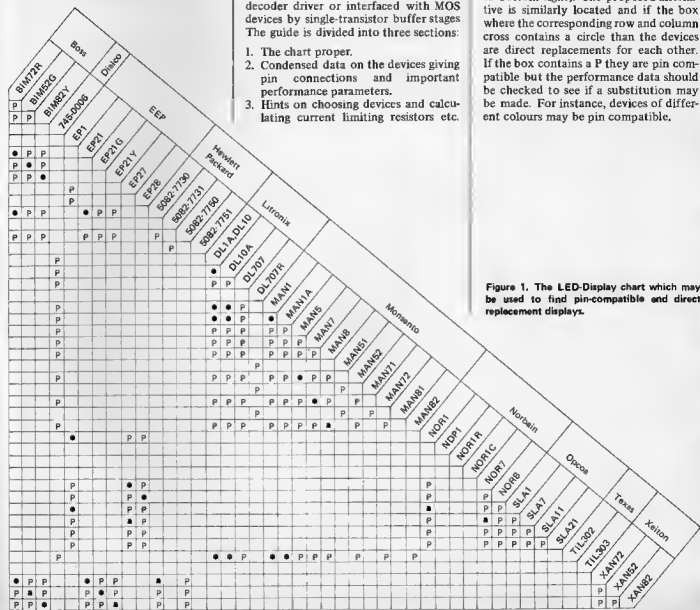

Figure 1. The LED-Display chart which may be used to find pin-compatible and direct replacement displays.

2
 Explanation of Symbols in figures 2.
 #g Segment cathodes.
 #g (see figure 3)
 L Left-hand decimal point cathode.
 R Right-hand decimal point cathode.
 f Upper decimal point (colon) cathode.
 A Anode.
 nc No connection.
 np No pin.
 λ_p Peak emission wavelength (nanometres).
 I_v Luminous intensity (millicandelas) at specified forward current.
 V_{fs} Segment forward voltage at specified current (milliamps).
 V_{fd} Decimal point forward voltage drop at specified current (volts).
 @If Specified forward current (milliamps).
 V_{rs} Max. segment reverse voltage (volts).
 V_{rd} Max. decimal point reverse voltage (volts).
 I_{W} Max. continuous forward current per segment (milliamps).
 Pot Max. total device dissipation (milliwatts).
 W Width (millimetres).
 H Height (millimetres).
 D Depth (millimetres).
 h Character height (millimetres).
 All the parameters listed are measured at 25°C. Values are typical, except for maximum ratings which must not be exceeded.

Manufacturer	Type number	Colour	Pin Function													Performance Data						Maximum Ratings			Dimensions								
			1	2	3	4	5	6	7	8	9	10	11	12	13	14	λ_p	I_v	V_{fs}	V_{fd}	@If	V_{rs}	V_{rd}	I_{W}	Pot	W	H	D	h				
Boss	BIM-72R	Red	e	f	A	np	nc	L	a	d	nc	c	g	np	b	A	697	0.25	1.9	1.9	10	5	5	25	400	10	19	4.5	7.7				
Boss	BIM-52G	Green	a	f	A	np	nc	L	a	d	nc	c	g	np	b	A	560	0.25	1.9	1.9	15	5	3	25	400	10	16	4.5	7.7				
Boss	BIM-82Y	Yellow	a	f	A	np	nc	L	a	d	nc	c	g	np	b	A	560	0.25	1.9	1.9	10	5	3	25	400	10	10	4.5	7.7				
Dialco	745-0006	Red	a	f	A	np	nc	L	a	d	nc	c	g	np	b	A	690	—	—	—	—	—	—	—	—	—	—	—	—	—			
EFP	EP1	Red	a	f	nc	nc	nc	L	a	d	nc	c	nc	c	A	650	1.0	2.1	2.1	16	—	—	—	—	—	—	—	—	—	—	—		
EFP	EP21	Red	a	f	A	np	nc	L	a	d	nc	c	g	np	b	A	697	0.25	1.9	1.9	15	3	3	25	400	10	19	4.5	7.7				
EFP	EP21G	Green	a	f	A	np	nc	L	a	d	nc	c	g	np	b	A	560	0.25	1.9	1.9	10	3	3	25	400	10	19	4.5	7.7				
EFP	EP21Y	Yellow	a	f	A	np	nc	L	a	d	nc	c	g	np	b	A	560	0.25	1.6	1.6	10	3	3	25	400	10	19	4.5	7.7				
EFP	EP27	Red	a	f	nc	nc	nc	L	a	d	nc	c	nc	c	A	630	—	—	—	—	—	—	—	—	—	—	—	—	—	—	—		
EFP	EP28	Red	a	f	nc	nc	nc	L	a	d	nc	c	nc	c	A	690	0.60	2.2	2.2	20	3	3	40	750	10	19	3.2	8.5					
Hewlett-Packard	5082-7730	Red	a	f	A	np	nc	L	a	d	nc	c	g	np	b	A	655	0.25	1.6	1.6	20	3	3	25	700	10	19	4.5	7.6				
Hewlett-Packard	5082-7731	Red	a	f	A	np	nc	L	a	d	nc	c	g	np	b	A	655	0.25	1.6	1.6	20	3	3	25	400	10	19	4.5	7.6				
Hewlett-Packard	5082-7750	Red	a	f	A	np	nc	L	a	d	nc	c	g	np	b	A	655	0.25	1.6	1.6	20	5	5	25	400	13	19	6.4	11.0				
Hewlett-Packard	5082-7751	Red	a	f	A	np	nc	L	a	d	nc	c	g	np	b	A	655	0.25	1.6	1.6	20	5	5	25	400	10	19	3.0	6.9				
Litronix	DLTA	Red	a	f	A	nc	L	a	d	A	c	g	nc	c	A	630	—	—	—	—	—	—	—	—	—	—	—	—	—	—	—		
Litronix	DL10	Red	a	f	A	nc	L	a	d	A	c	g	nc	c	A	630	—	—	—	—	—	—	—	—	—	—	—	—	—	—	—	—	
Litronix	DL10A	Red	a	f	A	nc	L	a	d	A	c	g	nc	c	A	630	—	—	—	—	—	—	—	—	—	—	—	—	—	—	—	—	
Litronix	DL707R	Red	a	f	A	nc	L	a	d	A	c	g	nc	c	A	630	1.4	1.7	1.7	20	3	3	30	500	11	20	7.4	7.6					
Litronix	DL707R	Red	a	f	A	nc	L	a	d	A	c	g	nc	c	A	630	1.4	1.7	1.7	20	3	3	30	500	11	20	7.4	7.6					
Monsanto	MAN1	Red	a	f	A	nc	L	a	d	A	c	g	nc	c	A	630	—	—	—	—	—	—	—	—	—	—	—	—	—	—	—	—	
Monsanto	MAN2	Red	a	f	A	nc	L	a	d	A	c	g	nc	c	A	630	—	—	—	—	—	—	—	—	—	—	—	—	—	—	—	—	—
Monsanto	MAN5	Green	a	f	A	np	nc	L	a	d	A	c	g	np	b	A	565	0.23	2.5	2.0	20	3	3	40	960	11	20	5.6	6.9				
Monsanto	MAN7	Red	a	f	A	nc	L	a	d	A	c	g	nc	c	A	630	0.7	2.5	2.0	20	3	3	30	750	10	19	3.0	6.9					
Monsanto	MAN7	Red	a	f	A	nc	L	a	d	A	c	g	nc	c	A	630	0.7	2.5	2.0	20	3	3	30	750	10	19	3.0	6.9					
Monsanto	MAN7	Yellow	a	f	A	np	nc	L	a	d	A	c	g	np	b	A	589	0.25	2.5	2.6	20	6	6	40	960	11	20	5.6	6.9				
Monsanto	MAN7	Yellow	a	f	A	np	nc	L	a	d	A	c	g	np	b	A	589	0.25	2.5	2.6	20	6	6	40	960	11	20	5.6	6.9				
Monsanto	MAN51	Green	a	f	A	np	nc	L	a	d	A	c	g	np	b	A	565	0.32	2.5	2.6	20	3	3	30	700	10	20	5.0	7.6				
Monsanto	MAN52	Green	a	f	A	np	nc	L	a	d	A	c	g	np	b	A	565	0.32	2.5	2.6	20	3	3	30	700	10	20	5.0	7.6				
Monsanto	MAN71	Red	a	f	A	np	nc	L	a	d	A	c	g	np	b	A	650	0.30	1.6	1.6	20	3	3	30	700	10	20	5.0	7.6				
Monsanto	MAN72	Red	a	f	A	np	nc	L	a	d	A	c	g	np	b	A	650	0.30	1.6	1.6	20	3	3	30	700	10	20	5.0	7.6				
Monsanto	MAN81	Yellow	a	f	A	np	nc	L	a	d	A	c	g	np	b	A	650	0.34	2.5	2.5	20	3	3	30	700	10	20	5.0	7.6				
Monsanto	MAN82	Yellow	a	f	A	np	nc	L	a	d	A	c	g	np	b	A	650	0.34	2.5	2.5	20	3	3	30	700	10	20	5.0	7.6				
Monsanto	MAN3610	Orange	a	f	A	np	nc	L	a	d	A	c	g	np	b	A	650	1.2	2.6	2.0	10	3	3	20	700	10	20	5.0	7.6				
Monsanto	MAN3620	Orange	a	f	A	np	nc	L	a	d	A	c	g	np	b	A	650	1.2	2.6	2.0	10	3	3	20	700	10	20	5.0	7.6				
Norbair	NOR1	Red	a	f	nc	nc	L	a	d	A	c	g	nc	c	A	690	1.0	2.1	2.1	15	5.5	5.5	40	780	10	19	3.1	8.4					
Norbair	NOR1	Red	a	f	nc	nc	L	a	d	A	c	g	nc	c	A	690	1.0	2.1	2.1	15	5.5	5.5	40	780	10	19	3.1	8.4					
Norbair	NOR1R	Red	a	f	A	nc	L	a	d	A	c	nc	nc	c	A	690	1.0	2.1	2.1	15	5.5	5.5	40	780	10	19	3.1	8.4					
Norbair	NOR1C	Red	a	f	nc	nc	L	a	d	A	c	nc	nc	c	A	690	1.0	2.1	2.1	15	5.5	5.5	40	780	10	19	3.1	8.4					
Norbair	NOR7	Red	a	f	nc	nc	L	a	d	A	c	g	nc	c	A	690	0.3	2.2	2.2	20	3	3	40	750	10	19	3.1	8.4					
Norbair	NOR7	Red	a	f	nc	nc	L	a	d	A	c	g	nc	c	A	690	0.3	2.2	2.2	20	3	3	40	750	10	19	3.1	8.4					
Norbair	NOR7	Red	a	f	nc	nc	L	a	d	A	c	g	nc	c	A	690	0.6	2.2	2.2	20	3	3	40	750	10	19	3.1	8.4					
Opoco	SLA1	Red	a	f	nc	nc	L	a	d	A	c	g	nc	c	A	690	1.0	2.1	2.1	15	5.5	5.5	40	750	10	19	3.2	8.4					
Opoco	SLA7	Red	a	f	nc	nc	L	a	d	A	c	g	nc	c	A	690	1.0	2.1	2.1	15	5.5	5.5	40	750	10	19	3.2	8.4					
Opoco	SLA11	Green	a	f	nc	nc	L	a	d	A	c	g	nc	c	A	690	0.3	2.1	2.0	3	3	3	40	750	10	19	3.2	8.4					
Opoco	SLA21	Yellow	a	f	nc	nc	L	a	d	A	c	g	nc	c	A	560	0.7	2.6	2.6	40	5.5	5.5	50	1480	10	19	3.2	8.4					
Opoco	SLA21	Yellow	a	f	nc	nc	L	a	d	A	c	g	nc	c	A	560	0.7	2.6	2.6	40	5.5	5.5	50	1480	10	19	3.2	8.4					
Opoco	TIL302	Red	a	f	A	np	nc	L	a	d	A	c	g	np	b	A	690	0.28	3.4	1.5	20	6	3	30	800	10	19	3.0	6.5				
Opoco	TIL303	Red	a	f	A	np	nc	L	a	d	A	c	g	np	b	A	690	0.28	3.4	1.5	20	6	3	30	800	10	19	3.0	6.5				
Xelton	XAN72	Red	a	f	A	np	nc	L	a	d	A	c	g	np	b	A	697	0.25	1.9	1.8	10	5	5	25	400	10	19	4.6	7.7				
Xelton	XAN52	Green	a	f	A	np	nc	L	a	d	A	c	g	np	b	A	560	0.25	1.9	1.8	10	5	5	25	400	10	19	4.6	7.7				
Xelton	XAN82	Yellow	a	f	A	np	nc	L	a	d	A	c	g	np	b	A	560	0.25	1.9	1.8	10	5	5	25	400	10	19	4.6	7.7				

Th
 The
 rel
 nat
 Wh
 fair
 par
 uni
 in
 fac
 mil
 brig
 Wh
 live
 phy
 dev
 pin
 sev
 acc
 bo
 the
 Ch
 Wh
 the
 fol
 1.
 com
 con
 and
 que
 is p
 In
 me
 are
 the
 onl
 cor
 ma
 sec
 sup
 pro
 dec
 seg
 one
 Wh
 acc
 asc
 wit
 nec
 pas
 to
 and
 wh
 pre
 pos
 bol
 can
 i
 why
 pos
 the
 of a
 r 3.

The Data

The data has been extracted from the relevant manufacturers' data sheets and presented in tabular form. An explanation of the symbols used is also given. Where a particular box in the table contains a dash this means either that the parameter is not specified or that the units are not the same as the units used in the table. For example, some manufacturers specify luminous intensity in millicandelas whereas others specify brightness in foot-lamberts.

When using the data to choose alternative devices it is important to check the physical dimensions of the device. Many devices have bodies that overhang the pins, so when using a p.c. board on which several devices are stacked close together check that there is sufficient space to accommodate the width of the device you propose to use. Some devices have bodies which are not symmetrical about the pins but are offset to one side and these have been excluded from this guide.

Choosing Seven-Segment Displays

When choosing alternative devices to those specified in a project, note the following points:

1. Devices that are not directly pin-compatible may often be used with slight modification. Many devices have similar connections for the segment cathodes and vary only in the connections to anode or decimal point. The most frequent connection for the common anode is pin 14. Some devices have additional anode connections, notably pins 3 and 9. In some cases the various anode pins are interconnected inside the package and are therefore redundant, in other cases the different anode pins are connected only to certain segments and must be connected externally. It is a simple matter to check which is the case. Connect one of the anode pins to a +5 V supply via a suitable limiting resistor and ground each of the segment pins and the decimal point pin in turn. If all the segments and the decimal point light then the anode pins are redundant and only one of them need be used.

When using a device with redundant anodes in a circuit board with a single anode connection simply cut off the unused anode pins. When using a device with multiple non-redundant anode connections it is necessary to bend the extra pins inwards and link them to the pin used for the common anode connection to the circuit board. Devices with fewer anode connections than the device for which a board was originally intended present no problems, provided that the pins which will go into anode connection holes on the board are NC or may be cut off.

2. Some devices are available in versions with left- or right-hand decimal point and are identical but for the decimal point connection. In applications where the decimal point is not required (for example clocks) the pin may be cut off if necessary.

3. Having established that a device is, or

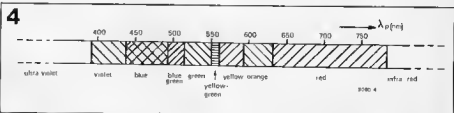
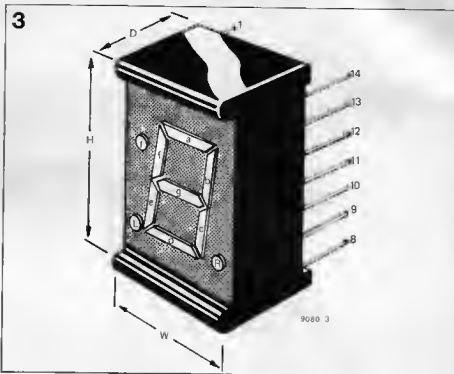

Figure 2. Table of pin connections and performance data for LED-Displays.

Figure 3. General appearance of a seven-segment LED-Display showing letter designation of segments and decimal points.

Figure 4. Relationship between light wavelength and perceived colour.

can be made, compatible with the board, the next thing to determine is whether the opto-electronic characteristics of the device are suitable. One of the most frequent of readers' queries concerns the substitution of displays of different colours to the ones originally specified. Provided the electrical characteristics are suitable this is perfectly acceptable but it must be remembered that yellow and green devices are often less efficient than red ones. This is particularly true of older designs of device which are often available on the amateur market. Yellow devices are the least efficient of all. This effect is fortunately offset to some extent by the fact that the eye is more sensitive to yellow and green than it is to red light, so although yellow and green displays are often less bright than red displays operated at the same current the apparent brightness is not much less. Nevertheless the difference is often noticeable.

4. To ensure long device life it is advisable to operate displays at or below the current specified in the I_f column. As this may involve recalculation of the cathode series resistors the formula is given below

$$R_k = \frac{V_b - V_{fs}}{I_f}$$

(V_b is the supply voltage; V_{fs} and I_f can be found from the table).

A similar calculation may be performed for the decimal point cathode resistor by substituting V_{fd} for V_{fs} .

When displays are used in a multiplexed (strobed) mode then they are only on for one n th of the time, where n is the number of displays being multiplexed. Consequently, to maintain the same brightness as if they were being driven continuously they will need to be supplied with n times the current for the time they are on. Most displays can be strobed at several times the continuous forward current I_{fw} . The formula for calculating the segment cathode resistors then becomes:

$$R_k = \frac{V_b - V_{fs}}{nI_f}$$

When operating with low supply voltages (e.g. TTL 5 V) it is advisable to subtract the saturation voltages of any transistors used in the multiplex drive circuitry from the supply voltage when calculating R_k .

Of course, where it is desired to increase the current when using an alternative display it is necessary to ensure that the circuit can supply the extra current.

modulation systems

As already announced in Part 1, this instalment deals with Carrier Position Modulation (CPM), as

well as with frequency and phase modulation. Frequency modulation has proved to be the best system for VHF broadcasting, while CPM is most suitable for speech transmission.

Carrier Position Modulation (CPM)

When a speech clipper is used, two questions arise:

1. What can be gained by using this system?
2. To what extent is intelligibility affected?

Experiments with HF clipping on SSB signals have demonstrated that intelligibility remains good even with infinite limiting, while the average power is increased by about 10 dB. If pre-emphasis is provided ahead of the LF chain, a further improvement in intelligibility results.

Even with infinite limiting of an SSB signal there are still some variations in its amplitude, since the rapid phase jumps of SSB signals give rise to frequency components outside the transmitted frequency band. Since these components are filtered out of the (constant) RF signal, the resultant transmitted signal must contain amplitude modulation.

If an SSB signal is to be purged of all amplitude variation, further signal processing is needed, and a PLL circuit happens to be suitable for this. Figure 16 shows the block diagram of an arrangement for producing CPM signals. An SSB signal is produced from a pre-emphasised LF input, and after this signal has been limited it is fed to a PLL circuit. The VCO in this circuit will oscillate at the same frequency as the SSB carrier, but without any amplitude variations. Component values in the

PLL are chosen to make it unable to follow rapid phase jumps in the SSB signal, so that the bandwidth of the CPM signal is not much greater than that of the original SSB-signal. Always provided that care is taken to maintain intelligibility, remarkably high efficiency can be achieved with CPM.

Figure 17 shows the relationship between intelligibility and receiver input voltage for different modulation systems. These are based on tests with sequences of unrelated words, and on the use of an IF section of the most suitable form for each system. For the same degree of intelligibility, the necessary input voltage with CPM is less than a third of what is needed with AM. This means that a CPM signal needs only one-tenth of the power needed for a 100%-modulated AM-signal, to cover the same distance. CPM thus offers higher efficiency for a given transmitter power.

CPM has only been known for a comparatively short time, and amateurs have experimented very successfully in this field. Arrangements based on the principle outlined in figure 16 are generally used, but this unfortunately has some disadvantages. The input signal to the balanced modulator exhibits amplitude variations depending, among other things, on the speaker and the speaker's distance from the microphone. The SSB signal must have greater amplitude than the carrier injected through P_1 , the purpose of which is to suppress noise

originating from the limiter when there is no modulation. In producing CPM, the LF signal must be suitably processed to avoid these subjective effects, and as already indicated, this cannot be done with clipping alone.

The results obtainable with rapid compression are almost the same as those which can be achieved with logarithmic amplification, so the latter method is preferable because of its simplicity.

The block diagram of a CPM transmitter with LF-signal processing is given in figure 18. A frequency band of 400 Hz to 3400 Hz from the microphone is amplified logarithmically and fed to the balanced modulator. The LF signal now has only a small degree of amplitude variation, and it is therefore possible to inject a higher level of carrier than would be acceptable without logarithmic amplification. This results in a better signal-to-noise ratio for the transmitted signal.

There is in addition another advantage to be gained from this configuration, namely that it can be used for phase modulation provided the level of carrier injection is sufficiently high. It can be shown that the PLL produces a phase-modulated signal if the balanced-modulator signal emerging from the filter is smaller than the injected carrier. The modulation index is a function of the quotient of these two voltages.

After the VCO signal has been directly transposed to the desired transmission frequency, it can be brought up to the power required by a Class-C amplifier. CPM can be received in the same way as SSB, but as an unmodulated carrier component is available for part of the time, a PLL can be used. Since a CPM signal contains no amplitude information, amplitude limitation in the receiver raises no problems, and this offers a simple means of combating AM interference in mobile applications. By way of verification of the advantages of CPM, experiments were carried out with an Ultra Low Power transmitter using the principles of figure 18. A frequency of 27 MHz was used, and the

Table 1.

System	Present application	Efficiency	Future applications
AM	Long-, medium- and shortwave broadcasting	very low	none
DSSC	communications networks	high	present applications continuing
SSB		very high	
CPM		exceptionally high	
FM	high-quality broadcasting	high	present applications continuing
NB-FM	communications networks	high	Long-, medium- and shortwave broadcasting
PM	usually changed to FM with integrating networks	moderate	current applications continuing

Figure 16. CPM (Carrier Position Modulation) is effected by processing an infinitely-clipped SSB signal using a PLL.

Figure 17. Relationship between intelligibility and receiver input-signal voltage (50% intelligibility is considered inadequate). Note that the order of merit gives first place to narrow-band FM (NB - FM), and not SSB.

Figure 18. Intelligibility can be considerably improved and lining-up simplified by the use of low-frequency signal processing.

Figure 19. The spectral distribution of an FM signal can be expressed with Bessel functions.

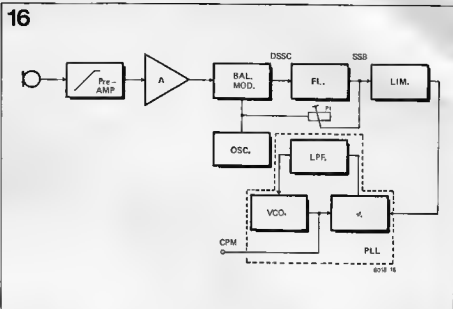

transmitter power was approx. 20 mW. In order to compensate, to some extent, for the unfavourable topographical conditions for VHF propagation - hilly country - the transmitter and its aerial were located on a floor of a block of flats 50 metres up. A loaded aerial rod was used, and the calculated efficiency of this combination was 30%, so that the ERP barely amounted to 6 mW. The receiver used for this experiment has a sensitivity of 0.1 μ V with a bandwidth

of 3 kHz and was equipped with a PLL of the type shown in figure 10 (see Elektor no. 2).

In spite of the transmitting aerial height, the optical horizon radius was a bare 7 km. Although reception within this area was subject to wide fluctuation, it was observed that the received signal did not drop below 0.2 μ V.

The limit of receiver sensitivity was reached at a range of 10 km, that is 3 km beyond the optical horizon.

When the transmitter was switched over to phase modulation, reception at the optical horizon was observed to have already become insufficient for reliable communication.

Frequency Modulation and Phase Modulation (FM and PM)

When the frequency or the phase of a carrier is made to vary in accordance with information, this is known as fre-

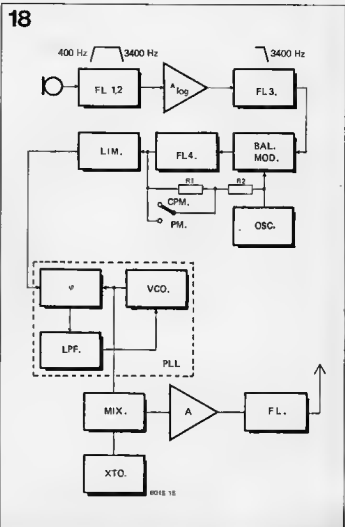
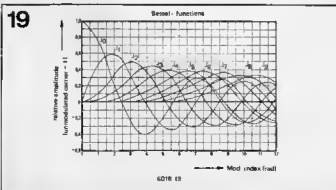
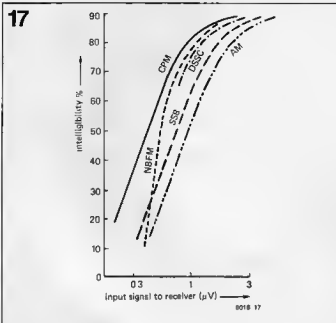

20

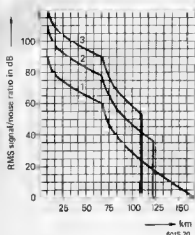

quency modulation or phase modulation respectively.

Both satisfy the relationship:

$$V = V_0 \sin(\omega_{hf} t + m \sin \omega_{mf} t) \quad (4)$$

in the case of sinusoidal modulation. The difference between FM and PM lies in the modulation index m , which is defined for FM as:

$$m = \frac{\text{frequency deviation of the RF carrier with respect to the centre frequency}}{\text{modulation frequency}} \quad (5)$$

and with phase modulation m is constant. The expression in (4) can be expanded to:

$$\begin{aligned} V = V_0 J_0 m \sin \omega_{hf} t + \\ J_1 m [\sin(\omega_{hf} t + \omega_{mf} t) + \\ \sin(\omega_{hf} t - \omega_{mf} t)] + \\ J_2 m [\sin(\omega_{hf} t + 2\omega_{mf} t) + \\ \sin(\omega_{hf} t - 2\omega_{mf} t)] + \\ J_3 m [\sin(\omega_{hf} t + 3\omega_{mf} t) - \\ \sin(\omega_{hf} t - 3\omega_{mf} t)] + \dots \end{aligned}$$

It can be seen from this that FM and PM generate a spectrum with infinite bandwidth. The term J_n indicates a Bessel function of the n th order, whose magnitude decreases substantially as n increases. In practice both FM and PM can therefore be considered to have a finite bandwidth. Figure 19 shows the amplitudes of sideband components as a function of m .

For FM broadcasting, a maximum fre-

21

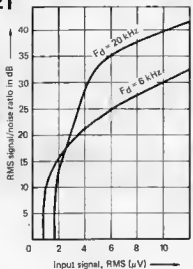

quency deviation of 75 kHz and a maximum modulation frequency of 15 kHz were standardised at the outset. It follows from (5) that $m = 5$, and it can be read off from figure 19 that, with this modulation index, the relative amplitude of the seventh-order sideband is only 0.05. This can be neglected in most cases because maximum modulation does not occur at 15 kHz in practice. A rule-of-thumb formula, valid when m is unity or greater, is: $B_w = 2(m + 1)f_{mf}$ max, in which B_w represents the -3 dB bandwidth, m is the modulation index at the maximum modulation frequency and f_{mf} max is the maximum modulation frequency.

The minimum bandwidth needed for mono FM then works out as: $B_w = 180$ kHz. For stereo FM the modulation index has been chosen, on compatibility grounds, to enable the mono bandwidth to be used at the highest modulation frequency (53 kHz). The modulation index for the sub-carrier signal conveying the stereo information can be shown to be 0.6 (as this is less than unity, the rule-of-thumb formula does not apply) which results in a 20 dB deterioration in signal-to-noise ratio. It can be derived from figure 19 that, with this low modulation index, the second-order sideband can be neglected in practice, as its relative amplitude is less than 0.05. The bandwidth required is then no greater than is needed for an AM system ($2 \cdot f_{mf}$ max).

24

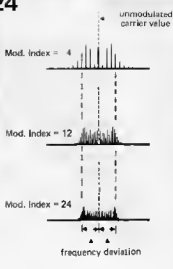

Figure 20. Relationship between distance covered and signal-to-noise ratio for AM (1), FM with 20 kHz deviation (2) and FM with 75 kHz deviation (3).

Figure 21. With reduced deviation, the maximum available signal-to-noise ratio also decreases.

Figure 22. With low deviations, there is considerable improvement in intelligibility at low input-signal levels.

Figure 23. These curves clearly show the superiority of narrow-band FM over AM of the same bandwidth.

Figure 24. Spectra showing that bandwidth can be fully utilised by increasing the modulation index for lower frequencies. This is the case for FM, since the deviation is determined by the amplitude of the modulating signal.

Figure 25. FM signals can be produced by modulating an LC oscillator with a varicap.

Figure 26. Varicap modulation of a crystal oscillator produces a combination of FM and PM.

22

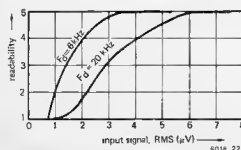

23

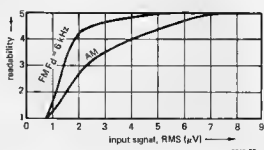

25

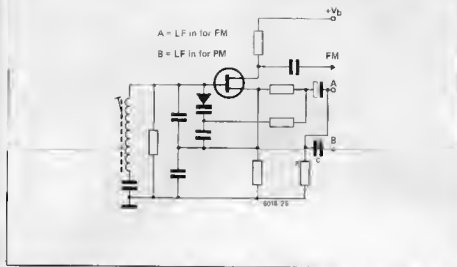

Associated with this lower value of m is a drop in the maximum signal-to-noise ratio obtainable, and therefore in the suppression of both impulsive and adjacent-channel interference.

One characteristic feature of FM is the threshold response: this means that the FM input signal strength must be above a certain value if it is to be usable. The threshold value goes down when a lower modulation index is used. This knowledge is based on research first carried out in the U.S.A. in the 'thirties to determine whether AM or FM would be best for a reliable police radio network. Some of the results of these very extensive researches are reproduced in figures 20, 21, 22 and 23.

The result of a terrain test is shown graphically in figure 20. In this case the transmitter location was fixed, while the receiver was mobile. Curve 1 is for AM, Curve 2 for FM with 20 kHz deviation and Curve 3 for FM with 75 kHz deviation. These curves show that a higher deviation is needed to give the high signal-to-noise ratio which hi-fi demands, but that a price has to be paid for this in terms of the maximum workable range.

Bearing in mind the 20-dB deterioration in signal-to-noise ratio with the present stereo system, it is of interest that stereo broadcasting using two separate transmission links, each with a deviation of only 20 kHz, would not only give a better signal-to-noise ratio, but would also offer a saving in overall bandwidth. For communication systems, used exclusively for speech transmission, a maximum modulation frequency of 3 kHz is adequate. Higher values, up to 5 kHz or 6 kHz, are used only when it is essential to transmit speech of very high intelligibility.

Figure 21 shows a comparison between a system with 20 kHz deviation and one with 6 kHz deviation. It will be seen that the ultimate sensitivity of the narrow-band system is better by a factor of 2. In communications networks, a signal-to-noise ratio of approximately 12 dB is regarded as just usable.

The amateur transmitters' readability gradings are also often quoted in intelligibility tests. In figure 22 the amateurs' intelligibility gradings are plotted against input signal for different values of deviation. The narrow-band system is quite usable with an input of 2 μ V, while the system with a 20 kHz deviation is unreadable with this input.

Although limiting sensitivity is considerably better nowadays because of improved reception techniques, this has no effect on the relationships between limiting sensitivities with the various systems.

A comparison between a narrow-band FM-system and an AM system with the same bandwidth is given in figure 23. The curves show the marked superiority of the FM system; this applies not only to intelligibility, but also to interference suppression. This points to a possible alternative for medium waves which would at least reduce the chaos prevailing in this band. By re-engineering the present AM channels for narrow-band FM with a deviation of 4.5 kHz, a substantial improvement would be achieved.

Anyone possessing a short-wave communications receiver equipped for narrow-band FM reception will find that, among others, a number of East European countries are radiating experimental narrow-band FM transmissions, particularly in the 25-m and 41-m broadcasting bands. These transmissions should be of particular service in shedding light on the effect of distortion caused by selective fading. This distortion seems to be considerably less with narrow-band FM than with AM and an envelope detector. As narrow-band FM is more compatible with AM than is SSB with a carrier, the change-over to narrow-band FM could take place gradually. This move is also advocated by the fact that, for the same signal-to-noise ratio, narrow-band FM would give a 70% saving in transmitter power. Particularly for narrow-band systems, there is a great difference between

26

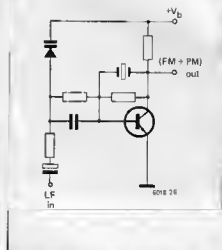

phase- and frequency modulation. Suppose, for example, that the deviation with FM is 4.5 kHz and the modulation frequency is 450 Hz, giving a value of 10 for m . This will result in a large number of sidebands whose main energy content (J_n in figure 19) is in the region of 9 kHz.

With phase modulation m is constant so that, in the case of narrow-band PM, as a first approximation two sidebands will be produced, depending on the modulation frequency. The sidebands of AM and narrow-band PM are thus identical, and this makes it possible to receive PM with an SSB receiver.

The efficiency of a communication system is highest when the available bandwidth is completely filled with information, and for this reason PM has a poorer signal-to-noise ratio than FM. This is illustrated in figure 24, where a higher modulation index is associated with lower modulation frequencies.

Figure 25 shows a simple arrangement for producing a frequency-modulated oscillation by introducing a varicap into the LC circuit of a stable oscillator, so that the oscillator frequency will vary with modulation. This circuit can be changed over from FM to PM simply by feeding the modulation through an RC section whose cut off frequency is equal to the highest modulation frequency. As the building of an oscillator which satisfies Post Office stability requirements is not exactly a simple business, crystal-controlled oscillators are preferable. With these, however, direct modulation of the oscillator frequency is not possible, as the maximum deviation cannot be more than 200 parts per million. However a crystal oscillator giving phase and frequency modulation simultaneously may be used, and this can have the same overall effect for communications purposes. An example of such a circuit is given in figure 26. In many instances, however, the deviation obtained with this circuit will be too small, and the required deviation can then be obtained with a frequency-multiplier circuit. One of many possible

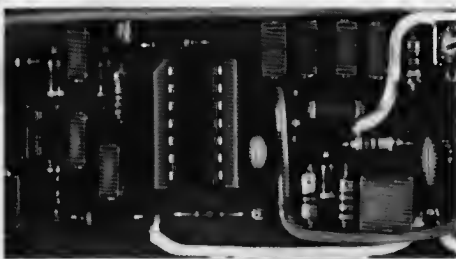

variants of this circuit is shown in figure 27, and calls for a minimum number of stages. Crystal-controlled oscillators XTO_1 and XTO_2 oscillate at frequencies f_1 and f_2 . These frequencies are multiplied by n and $(n+1)$ respectively and then fed to a mixer stage, the output of which is tuned to:

$$f_{out} = (n+1)f_2 - nf_1.$$

The two oscillators are modulated with opposite polarities, via a phase splitter, giving deviations of Δf_1 and Δf_2 respectively, so that the mixer output becomes:

$$f_{out} + f_h = (n+1)(f_2 + \Delta f_2) - n(f_1 - \Delta f_1).$$

This can be rearranged to give the value of the deviation f_h , i.e.:

$$f_h = (n+1)\Delta f_2 + n\Delta f_1.$$

In the case where $f_1 = f_2$ and $\Delta f_1 = \Delta f_2$, this gives:

$$f_h = (2n+1)\Delta f_1,$$

with a centre frequency:

$$f_{out} = f_1.$$

A practical value for n is three, as this can be effected with one stage of multiplication. This gives a seven-fold multiplication of the deviation, with an output frequency equal to that of the crystal oscillators.

When FM signals are detected, imperfect demodulation causes divergences from theoretical values (e.g. for interference suppression), and these divergences increase as the bandwidth of the system is reduced. For this reason, special care should be devoted to the instrumentation of narrow-band FM systems, but unfortunately the opposite has been true in the past.

Conclusion

It has been shown that there are only two modulation systems offering high efficiency, namely FM and CPM. However, since CPM conveys no information on amplitude, this system is only suitable for speech transmission. AM is in every respect the worst system. Although it appears at first sight to offer economic advantages, closer study shows up the disadvantages of AM such as energy wastage, wavelength clutter and its contribution to the warming up of the ionosphere.

FM has rightly been chosen for high-quality broadcasting, but even FM is marred by distortion and noise when new systems, which reduce the modulation index severely, are introduced. Stereo broadcasting with its information bandwidth of 53 kHz is a striking example of this, but it would seem that yet another step in the wrong direction is about to be taken with the introduction of quadraphonic broadcasting. For a number of quadro systems now being discussed, a bandwidth of 'only' 76 kHz is needed. In view of the widespread operation of FM transmitter networks with a channel spacing of 100 kHz, it would be preferable to look for techniques which do not call for any increase in the present bandwidth.

Figure 27. With this arrangement, deviation can be increased without the increase in output frequency which occurs with direct multiplication.

27

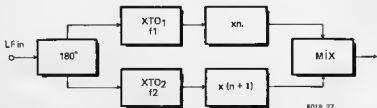

8018 27

THE MISSING LINK

Modifications to
Additions to
Improvements on
Corrections in
Circuits published in Elektor

Steam whistle

In the p.c.b. layout for the steam whistle (Elektor 1, p. 58), the electrolytic capacitors C_4 , C_7 and C_9 are shown with the wrong polarity. The negative connections of C_4 and C_7 should be connected to the negative supply line near the emitter of T_2 ; the positive connection of C_9 should be connected to the cathode of D_1 . The circuit diagram (figure 2) is correct.

COMING SOON IN ELEKTOR

feedback
PLL receiver

TUP/TUN tester

quadro in practice

car electronics

H/L logic probe

TUP TUN DUG DUS

Wherever possible in Elektor circuits, transistors and diodes are simply marked 'TUP' (Transistor, Universal PNP), 'TUN' (Transistor, Universal NPN), 'DUG' (Diode, Universal Germanium) or 'DUS' (Diode, Universal Silicon). This indicates that a large group of similar devices can be used, provided they meet the minimum specifications listed above.

For further information, see the article 'TUP-TUN-DUG-DUS' in Elektor 1, p. 9.

	type	U_{ce0} max	I_c max	h_{fe} min	P_{tot} max	f_T min
TUN	NPN	20 V	100 mA	100	100 mW	100 MHz
TUP	PNP	20 V	100 mA	100	100 mW	100 MHz

Table 1a. Minimum specifications for TUP and TUN.

Table 1b. Minimum specifications for DUS and DUG.

	type	U_R max	I_F max	I_R max	P_{tot} max	C_D max
DUS	Si	25 V	100 mA	1 μ A	250 mW	5 pF
DUG	Ge	20 V	35 mA	100 μ A	250 mW	10 pF

Table 2. Various transistor types that meet the TUN specifications.

TUN		
BC 107	BC 208	BC 384
BC 108	BC 209	BC 407
BC 109	BC 237	BC 408
BC 147	BC 238	BC 409
BC 148	BC 239	BC 413
BC 149	BC 317	BC 414
BC 171	BC 318	BC 547
BC 172	BC 319	BC 548
BC 173	BC 347	BC 549
BC 182	BC 348	BC 582
BC 183	BC 349	BC 583
BC 184	BC 382	BC 584
BC 207	BC 383	

Table 3. Various transistor types that meet the TUP specifications.

TUP		
BC 157	BC 253	BC 352
BC 158	BC 261	BC 415
BC 177	BC 262	BC 416
BC 178	BC 263	BC 417
BC 204	BC 307	BC 418
BC 205	BC 308	BC 419
BC 206	BC 309	BC 512
BC 212	BC 320	BC 513
BC 213	BC 321	BC 514
BC 214	BC 322	BC 557
BC 251	BC 350	BC 558
BC 252	BC 351	BC 559

Table 4. Various diodes that meet the DUS or DUG specifications.

DUS	DUG
BA 127	OA 85
BA 217	BAX 13
BA 218	OA 91
BA 221	1N914
BA 222	1N4148
BA 317	AA 116

Table 5. Minimum specifications for the BC107, -108, -109 and BC177, -178, -179 families (according to the Pro-Electron standard). Note that the BC179 does not necessarily meet the TUP specification ($I_{c,max} = 50$ mA).

	NPN	PNP
	BC 107 BC 108 BC 109	BC 177 BC 178 BC 179
V_{ce0} max	45 V 20 V 20 V	45 V 25 V 20 V
V_{eb0} max	6 V 5 V 5 V	5 V 5 V 5 V
I_c max	100 mA 100 mA 100 mA	100 mA 100 mA 50 mA
P_{tot} max	300 mW 300 mW 300 mW	300 mW 300 mW 300 mW
f_T min	150 MHz 150 MHz 150 MHz	130 MHz 130 MHz 130 MHz
F max	10 dB 10 dB 4 dB	10 dB 10 dB 4 dB

The letters after the type number denote the current gain:

- A: α^f (β , h_{fe}) = 125-260
 B: α^f = 240-500
 C: α^f = 450-900.

Table 6. Various equivalents for the BC107, -108, ... families. The data are those given by the Pro-Electron standard; individual manufacturers will sometimes give better specifications for their own products.

NPN	PNP	Case	Remarks
BC 107	BC 177		
BC 108	BC 178		
BC 109	BC 179		
BC 147	BC 157		$P_{max} = 250$ mW
BC 148	BC 158		
BC 149	BC 159		
BC 207	BC 204		
BC 208	BC 205		
BC 209	BC 206		
BC 237	BC 307		
BC 238	BC 308		
BC 239	BC 309		
BC 317	BC 320		$I_{cmax} = 150$ mA
BC 318	BC 321		
BC 319	BC 322		
BC 347	BC 350		
BC 348	BC 351		
BC 349	BC 352		
BC 407	BC 417		$P_{max} = 250$ mW
BC 408	BC 418		
BC 409	BC 419		
BC 547	BC 557		$P_{max} = 500$ mW
BC 548	BC 558		
BC 549	BC 559		
BC 167	BC 257		169/259
BC 168	BC 258		$I_{cmax} = 50$ mA
BC 169	BC 259		
BC 171	BC 251		251... 253
BC 172	BC 252		low noise
BC 173	BC 253		
BC 182	BC 212		$I_{cmax} = 200$ mA
BC 183	BC 213		
BC 184	BC 214		
BC 582	BC 512		$I_{cmax} = 200$ mA
BC 583	BC 513		
BC 584	BC 514		
BC 414	BC 416		low noise
BC 414	BC 418		
BC 414	BC 416		
BC 413	BC 415		low noise
BC 413	BC 415		
BC 382			
BC 383			
BC 384			
BC 437			$P_{max} = 220$ mW
BC 438			
BC 439			
BC 467			$P_{max} = 220$ mW
BC 468			
BC 469			
	BC 261		low noise
	BC 262		
	BC 263		

TUP TUN DUG DUS

A. Deley

led-level

In general, analogue pointer instruments are used for level indicators. Another method of

indicating amplitudes and power is to use LED's. The advantages of this system include higher resistance to shock, better legibility from greater distances and the fact that the response time is unaffected by the mechanical time-constant of a conventional meter.

Apart from a practical level meter additional circuits are discussed. The most important of these is a simple overload indicator.

Figure 1 gives a simple circuit with which the voltage amplitude on the loudspeaker output of an amplifier can be converted into light intensity of lamp L_1 . The limiting resistor R_1 is necessary only if the lamp can be overdriven by the amplifier. Of course with a single supply rail amplifier the circuit of figure 1 must be connected after the loudspeaker output capacitor. Otherwise the lamp would be constantly fed from the d.c. mid-point voltage of the amplifier output stage.

Lamp L_1 must burn brightest at maximum output power. This power is normally limited by the supply voltage of the output amplifier. In most cases it can be said that the maximum output is obtained if the amplitude of the output voltage is about 2 volts less than the supply voltage (also in connection with increasing distortion). If, for example, the supply voltage of the amplifier is 24 volts, the maximum swing of the output voltage will then be about 22 volts peak-to-peak.

The maximum RMS output voltage of the output stage (from the example) is half the peak-to-peak voltage divided by $\sqrt{2}$. This is about 7.8 volts. The maximum voltage of the lamp is 6 volts, so the surplus of 1.8 volts must drop across R_1 . The resistance value of R_1 can now be calculated by dividing the residual voltage (1.8 volts) by the 50mA which is the maximum current for the lamp.

The level indicator

Such a simple system can, at best, give only an approximate indication of output and its effectiveness depends on many factors such as ambient lighting

and the eyesight of the individual user. A much better arrangement is to have a number of lamps or LEDs which light in sequence as the voltage is increased. This is the system used in the LED level indicator.

The circuit is shown in figure 2. The input of the circuit is formed by potentiometer

meter P_1 with which the sensitivity is adjusted. The potentiometer is connected to the loudspeaker output of the amplifier. If the amplifier is fed asymmetrically (one supply voltage), potentiometer P_1 must be connected after the loudspeaker output capacitor.

The circuit operates as follows:

2

Parts list with figure 2

Resistors:

$R_1 \dots R_{10} = 1k$
 $R_{11} \dots R_{20} = 200\Omega$ (see text)
 $P_1 = 1k$, preset potentiometer
 $P_2 = 470\Omega$, preset potentiometer

Capacitor:

$C_1 = 22\mu/16V$

Semiconductors:

$T_1 = 2N1613$
 $T_2 \dots T_{11} = TUN$
 $O_1 \dots O_{10}$ and $O_{21} = OUS$
 $O_{11} \dots O_{20} = LED$ (for example
 Hewlett-Packard type 5082-4480,
 Texas TIL209)

$T_2 \quad T_{11} = TUN$
 $D_1 \quad D_{10} = DUS$
 $D_{11} \quad D_{20} = LED$
 e.g. HP
 type 5082-4480

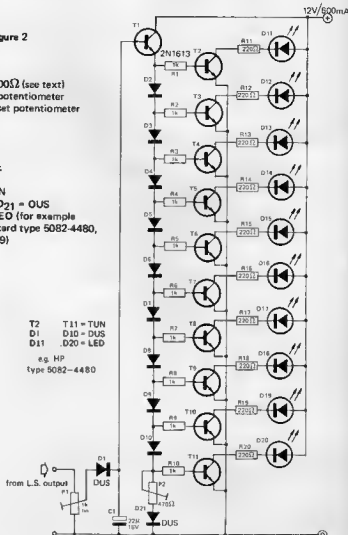

1

LS output



1532 1

1532 2

Parts list with figure 4

Resistors:

$R_1 = 1\text{ M}$
 $R_2 = 330\text{ k}$
 $R_3, R_4 = 10\text{ k}$
 $R_5 = 270\Omega$
 $R_6 = 1\text{ k}$
 $R_7, R_8 = 475\Omega$
 $P_1 = 1\text{ M, preset potentiometer}$

Capacitors:

$C_1 = 0.47\mu\text{M}$
 $C_2 = 100\mu\text{M}/10\text{ V}$ (see text)
 $C_3 = 100\mu\text{M}/35\text{ V}$

Semiconductors:

$T_1, T_2, T_3 = \text{TUN}$ (above $U_b = 20\text{ V: BC107a}$)
 $T_4 = 2\text{N1613}$
 $T_5 = 2\text{N2905}$
 $D_1, D_2 = \text{DUS}$

The output voltage of the amplifier arrives on diode D_1 via potentiometer P_1 . This diode rectifies the signal positively. Via D_1 capacitor C_1 is charged. If the voltage across C_1 increases, there will come a point where T_1 conducts. If the voltage on C_1 rises further, transistor T_2 will be driven into conduction via resistor R_1 .

A resistor and LED are included in the collector of T_2 . When T_2 conducts, the LED lights. If the voltage on C_1 rises still further, transistor T_3 conducts because its base is driven via diode D_2 and resistor R_2 . Now LED D_{12} will also light. As long as the voltage on capacitor C_1 keeps rising, another diode in the chain $D_2 \dots D_{21}$ conducts. Each of the corresponding transistors ($T_2 \dots T_{11}$) and LEDs ($D_{11} \dots D_{20}$) also conducts. When the emitter potential of T_1 is about 7 volts, all ten LEDs will be lit.

If the LEDs are placed in line horizontally or vertically the result is a light track whose length is proportional to the output amplitude of the amplifier. Potentiometer P_2 in the emitter circuit of T_1 serves to adjust and limit the current. The indicator responds rapidly to an increase of the output voltage of the amplifier. The decay time of the meter (light track) depends on the value of capacitor C_1 .

At a greater capacitor value the decay time becomes longer. At the indicated value for C_1 the decay time is about 0.3 seconds.

The circuit may also be fed from higher voltages. But then the values of R_{11} up to and including R_{20} must be adapted. The proper values can be calculated if we assume that the supply voltage drops at least 1.5 volts across a LED and that the current through the resistors is about

Figure 1. The simplest form of level indicator can be made with a lamp and a resistor. As the output voltage increases, the lamp will produce more light. The indication of such a system is not accurate, and for small voltages the lamp does not light.

Figure 2. The LED level indicator fitted with ten LEDs. Each time the output voltage increases by about 0.7 V an additional LED will light up. If the LEDs are mounted in line horizontally or vertically the result is a "thermometer" type indication. The length of the track is an indication of the amplitude of the output. It is possible to use lamps instead of LEDs. Depending on the type of lamp used, the load resistors R_{11} up to and including R_{20} may be omitted.

Figure 3. To obtain an indication at low output voltages the anode of diode D_1 of figure 2 must receive a bias voltage. This is done by means of an additional adjustment potentiometer (P_v), resistor (R_v) and diode (D_v).

Figure 4. If the level indicator must be driven from a high-output-impedance or low-voltage source a preamplifier circuit can be used. Its voltage amplification is 100 or more, depending on the gain of T_3 .

Figure 4a. This voltage doubler can replace diode D_1 (figure 2) if the indicator fails to give full deflection. The voltage doubler consists of two diodes (D_2 and D_v) and two capacitors (C_2 and C_v). The doubler can only be used if the meter has an independent supply. As appears from the diagram, the loudspeaker zero and level meter zero (minus terminal of C_1) are not D.C. connected.

3

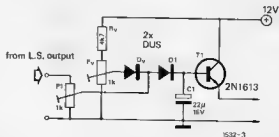

4a

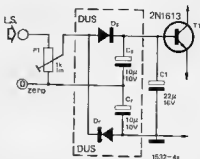

4

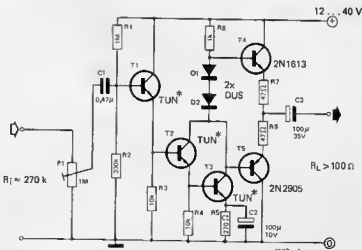

* see list of components

40mA. (Ensure that the LED's used will stand this current).

If the supply voltage is more than 20 volts it is not possible to use a TUN. Up to a supply voltage of 40 volts the TUN's can be replaced by BC107a or BC107b.

Instead of LED's ordinary incandescent lamps can be used. Their operating

voltage can best be chosen to equal the supply voltage. In that case a load resistor (R_{11} up to and including R_{20}) is not needed.

A drawback of the circuit of figure 2 is that the first LED begins to conduct only after a bias has been built up. If this is unacceptable, the circuit can be pre-biased with a resistor, potentiometer, and diode. Figure 3 gives a detailed drawing of the input circuit of figure 2 with the additional components. The bias is adjusted with potentiometer P_V . Diode D_V serves only to avoid extra loading of the positive-going loudspeaker signal.

Level preamplifier

If the level indicator must be connected to a point in the amplifier where there is not sufficient voltage (and power) to drive it, the circuit of figure 4 may be used. This circuit is inserted between the

connecting point in the amplifier and potentiometer P_1 of figure 2.

The input impedance of the circuit of figure 4 is about 270 k. The voltage amplification with P_1 at maximum is 100 X or more. This depends on the gain of transistor T_3 . The circuit of figure 4 may be connected to supply voltages between 12 volts and 40 volts. For supplies higher than 20 volts the TUN's must be replaced by transistors which can withstand this voltage (for example BC107). Furthermore, the operating voltage of capacitor C_3 should be at least equal to the supply voltage.

If the supply voltage for the circuit of figure 4 is less than 20 volts, the level meter cannot be fully driven under normal conditions. To achieve this, diode D_1 (from figure 2) must be replaced by a voltage doubler, so that capacitor C_1 (of figure 2) receives about twice the voltage (see figure 4a).

Overload indicator

It can be quite handy if a power amplifier is provided with a device that indicates when the amplifier is overdriven: an overload indicator. Figure 5 gives a practical example. The input is connected to the output of the amplifier. Since we are now concerned with overdrive, the input must be connected before the loudspeaker elco.

The threshold level of the overload indicator may be adjusted by potentiometer P_1 . This adjustment must be such that if a certain level is exceeded, the μA 741 switches, and produces a positive voltage. This voltage drives transistor T_1 . The emitter circuit of T_1 includes an incandescent lamp or LED which then lights.

The overload indicator of figure 5 can also be used for higher voltages (up to 37 volts). The value of resistor R_3 must be increased in proportion with the higher supply voltage. To ensure the survival of the IC, the input voltage should not be more than the supply voltage. For this reason an extra resistor (R_x) of 10 ... 22k in the input lead may be needed.

Physiological correction

If the level indicator must give an audio-physiologically corrected indication, the network of figure 6 can be connected between the meter and the loudspeaker output. This network gives an attenuation of about 4 X. If the input voltage is then insufficient to drive the meter to maximum indication, there are two possible solutions. The voltage doubler of figure 4a can be used, or alternatively the circuit of figure 4 can be connected between the correction network output and the input of the level indicator. In that case potentiometer P_1 and the capacitors C_1 and C_2 can be omitted from the circuit of figure 4.

With the audio-physiologically corrected level meter it is necessary to use an overload indicator, because it is impossible to see when the amplifier is giving its peak power.

Figure 5. This overload indicator can be used universally. The input must be connected to the output of the amplifier before the output capacitor.

Figure 6. If the level indicator must give an audiophysically corrected indication, this network may be connected between the loudspeaker output and the input of the meter.

5

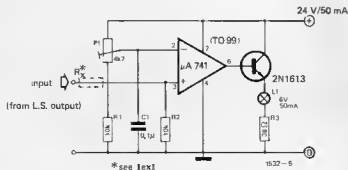

* see 1ex1

Parts list with figure 5

Resistors:

$R_1, R_2 = 10k$
 $R_3 = 395\Omega$ (see text)
 $P_1 = 4k7$, preset potentiometer

Capacitor:

$C_1 = 0.1\mu$

Semiconductors:

$T_1 = 2N1613$
 $IC_1 = \mu A 741$

Lamp:

$L_1 = 6 V, 50mA$ (see text)

Parts list with figure 6

Resistors:

$R_1 = 1k2$
 $R_2, R_3, R_4 = 10k$
 $R_5 = 3k3$
 $R_6, R_7 = 470k$
 $R_8 = 4k7$

Capacitors:

$C_1 = 39n$
 $C_2 = 47n$
 $C_3 = 0.22\mu$
 $C_4 = 33n$
 $C_5 = 0.27\mu$
 $C_6 = 15n$
 $C_7 = 0.33\mu$
 $C_8 = 100\mu/35 V$

Semiconductors:

$T_1, T_2 = BC107a$

6

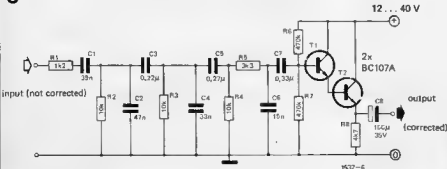

MARKET

Quadrophonic cartridge from Elac

A new range of pickup cartridges manufactured by Electro-acoustic GmbH of West Germany is now available in Great Britain.

Illustrated is the ELAC STS 655-D4 cartridge, which is designed for playing quadrophonic carrier discs. It is fitted with a parabolically ground Shibata diamond stylus and will track at up to 50 kHz. The cartridge may also be used with normal stereo or matrix quadrophonic discs. Elac cartridges range in price from £10-£49.



up to three decades, with sweep rates from 1 mS to 10 S. A separate TTL compatible square-wave output is provided. Size is 187 x 73 x 216 mm (7.5 x 2.9 x 8.6 inches) and it weighs less than 1 kg. Price is £195.

Logic Probe

A new TTL/DTL logic probe is available from Intercontinental Components Ltd. Readout is by four LED's. H and L to indicate high or low logic states at the input and Q and \bar{Q} , to indicate the state of a storage latch, which toggles on a positive transition at the input. The probe derives its 45 mA supply current from the circuit under test and is reverse polarity protected. Probe input current is 2.4 mA max. and response time is 50 ns. The one-off price is £11.50.



New family of low-power TTL devices

National Semiconductor have announced the start of volume production of a new range of low-power TTL devices known as 54 LS/74 LS Low-Power Schottky or LPS. The first nine types, 74 LS00, 01, 03, 04, 10, 12, 20, 22, and 30 are now available in quantity. Suggested resale unit prices in lots of 100's are £0.20 for all gates, except the 74LS04 which is priced at £0.22. It is anticipated that, by mid-1976, all of the popular circuits that are now in the standard 54/74 family will have been duplicated. The 54LS/74LS devices are claimed to have the best speed-to-power ratio of any high-speed logic family on the market. Compared with standard TTL devices, low-power

Schottky logic dissipates only one-fifth the amount of power (2 mW per gate) while making no sacrifice in operating speed. Low-power Schottky will replace most high-speed TTL logic, and can be used in some Schottky TTL applications, as well as standard TTL, since the LS series has dynamic characteristics that closely approximate those of the standard 54/74 TTL. It is possible to remove a 7400 device and insert a 74 LS 00 device in its place and obtain the same speed with lower power consumption.

Compact digital multimeter

The 'Danameter' is an almost pocket-sized digital multimeter from Dana Electronics Ltd. The instrument is powered by a single 9 V transistor radio battery, which should last for up to a year of normal use, and has a 3½ digit liquid crystal display that adjusts itself to ambient light levels. Sixteen ranges are selectable by means of a single, 18-position switch, with two positions for 'off' and battery test. The case is moulded in high-impact a.b.s. plastic and the manufacturers claim that the meter will survive bench-high drops and drastic electrical overloads such as 250 V on the ohms ranges. Ranges are 2, 20, 200 and 1000 Ω, C. and A.C. 20 μA, 2 mA, 200 mA and 2A O.C. 200 ohms, 20 k and 2 M. Dimension are 102 x 184 x 57 mm. (4 x 7.25 x 2.25 inches) and the weight is 0.45 kg (1 lb.). Price of the basic Danameter is £99.50.



Versatile Multimeter

A new multimeter is available from Metrawatt U.K. Ltd. The Unigor A42 Multimeter has a total of 30 measuring ranges for A.C./D.C. current and voltage, and resistance.

Ranges are: D.C. volts, 60 mV-12 kV, accuracy ± 1% F.S.O.
A.C. volts, 6 V-12 kV, accuracy ± 1% F.S.D.



D.C. amps, 60 μA-30 A, accuracy ± 1% F.S.O.
A.C. amps, 0.6 mA-30 A, accuracy ± 1.5% F.S.D.
ohms, 0-1 M, accuracy ± 1.5% full scale,
± 6% true value at mid-scale.

The instrument is shock-proof and overload protected, measures 212 x 110 x 82 mm (8.5 x 4.4 x 3.3 inches) and weighs 1 kg (2.2 lb.). A range of accessories is available. One-off price is £55.

New Varactor Diodes

The ITT Components Group is introducing a number of new types of varactor diode. This VUE series consists of an improved range of step-recovery mesa diodes with a screened epitaxial structure. These components can be used in frequency multipliers with output frequencies from 4-8 GHz to 10-14 GHz.

The VUE series comprises the tuning diodes VSA413H, VSA417H, VYA413H and VYA417H, all of which are suitable for the VHF and UHF bands as well as for microwave frequencies. The minimum quality factor at 50 MHz is 1000 for the 413H types and 800 for the 417H types.



Camouflaged Speakers

For those who wish their Hi-Fi to be unobtrusive, the ECHONICA speakers from Japan may be the answer. Having the appearance of a picture in a frame only 1½ inches deep, these speakers are designed for wall mounting. The 'canvas' of the picture is the loudspeaker diaphragm and a range of 60 pictures is available. The price is £47.00 a pair plus V.A.T.



Low-cost 50-ohm Sweep/Function Generator

A new sweep/function generator is available from Dana Electronics Ltd. The model 196A offers sine, triangle, square, pulse, ramp and sweep waveforms over the range 0.1 Hz to 1 MHz, in seven ranges. The generator will provide 10 V open-circuit or 20 V into a 50 ohm load. Attenuation up to 70 dB is provided in two 20 dB fixed steps and a 30 dB variable. An internal sweep generator will sweep the output frequency over

ELECTROVALUE



Catalogue 7 issue no 3

- UP-DATED PRODUCT & PRICE INFORMATION
- REFUND VOUCHER

We have made it just about as comprehensive and up-to-the-minute as possible 112 pages plus cover. Thousands of items from vast ranges of semi-conductors including I.C.s to components, tools, accessories, technical information and diagrams are included as well as a refund voucher worth 25p for spending on orders list value £5 or more **SEND NOW FOR YOUR COPY BY RETURN.**

30 p.p.p.

• E.V. PRICE STABILIZATION POLICY

Prices shown in catalogue no. 7, issue 3 will be reviewed on 1st April 1976 and held for 3 months before further review (except in cases of severe market fluctuations).

• E.V. DISCOUNT PLAN

Applies to all items except the few where prices are shown NETT, 5% on orders from £5 to £14.99; 10% on orders value £15 or more (list value).

• FREE POST & PACKING

In UK for pre-paid mail orders over £2 (except Box-and-all cabinets). If under £2 there is an additional handling charge of 10p.

• QUALITY GUARANTEE

All goods are sold on the understanding that they conform to makers specifications. No

ELECTROVALUE LTD

All communications to Section 84.3.
28 ST. JAMES ROAD, ENGLEFIELD GREEN, EGHAM, SURREY TW20 0NH.
Telephone Egham 383.3. Telex 264475. Shop hours: 9-5.30 daily 8-1 p.m. Sat.
NORTHERN BRANCH: 690 Barnage Lane, Barnage, Manchester M19 1NA.
Telephone 0511 432 6945. Shop hours: Daily 9-5.30 p.m. 8-1 Sat.
U.S.A. CUSTOMERS are invited to contact ELECTROVALUE AMERICA,
P.O. Box 27, Swarthmore PA 18615.

Hannover Messe '75

16.-24. April



Wir stellen aus:

Halle 12
Stand 1000



Wir freuen uns
über Ihren Besuch.



ELEKTOR VERLAG GMBH
D-5133 Gangelt 1, W-Germany Tel. (W. Germany) 02454-5055

MACK'S ELECTRONICS



Elektor MOS Clock boards and components in stock

We specialise in high-quality components at unbeatable prices.

Full range of Elektor boards ex-stock.

MOS Clock (two boards)	£ 1-90
TV Sound	£ 1-30
High quality Disc Preamp	£ 0-85
Aerial Amplifier	£ 0-85

MACK'S ELECTRONICS

283 Edgware Road, London W2.

Tel. 01-262 8614

Hours of business 9.30 - 6.00
Monday to Saturday

Now you can change record-speeds without changing record-speeds.



We've done away with the old turntable speed-control, on this very advanced Philips GA209 record deck.

Simply by placing a record on the turntable the correct speed is electronically chosen and the pick-up lowered gently into the run-in groove.

At the end of the record the turntable stops and the arm returns to the rest.

This facility ensures that both the record and stylus are fully protected.

In manual operation, the pick-up can be positioned over the grooves and lowered by means of a touch control.

The mechanism permits very accurate positioning. Controlled by a servo motor via electronic touch controls, it can be operated whether the deck is used manually or as a fully automatic deck.

Electronic control makes sure that the turntable speed is kept constant.

Separate fine speed controls for 33 1/2 and 45 rpm. allow the record to be tuned to the pitch of any musical instrument.

The photo-electric stop switch is completely soundless and frictionless.

High stability and insulation against shocks and vibration are ensured by the floating suspension of the

turntable and pick-up arm.

The tracking error of the practically frictionless pick-up arm is very small.

Side thrust compensation is adjustable for all playing weights for both spherical and elliptical styli.

The top cartridge from the Super M range, the GP412, is supplied as standard.

Shown in manual position to illustrate control panel.



PHILIPS
Simply years ahead