

up-to-date electronics for lab and leisure

ELEKTOR

equa amplifier
quadro systems
tap sensor
steam whistle
distortion meter
mos clock

December 1974 35p

Sminder



Motorola LED sentries never die.

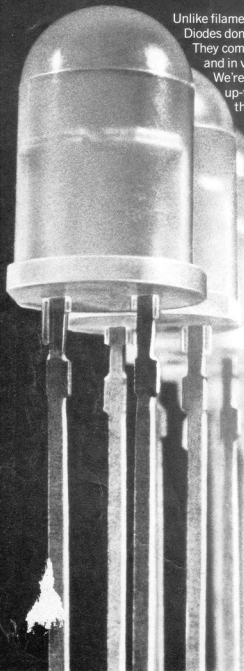

Unlike filament indicator lamps, Motorola Light Emitting Diodes don't die.

They come in three colours — red, yellow and green — and in viewing angles to suit all applications.

We're so confident of your determination to be up-to-date, that we've invested heavily to give you the LEDs you want, when you want them.

Use indicator lamps that are worthy of your equipment. Use Motorola LEDs as sentries to watch over it.

To find out more about the design possibilities of these high-reliability products, just send for the new Motorola Opto Electronics brochure, which gives you information about our light detectors and couplers too.

You'll find it profitable reading.



MOTOROLA Semiconductors

Motorola Semiconductors Ltd., York House,
Empire Way, Wembley, Middlesex. Telephone: 01-902 8836
European manufacturing facilities at Toulouse and East Kilbride.
Distributors: Celdis Ltd., Reading, East Kilbride,
GDS (Sales) Ltd., Slough, Dublin, Jermyr, Sevenoaks;
Lock Distribution, Olcham; Semicomps Ltd., Wembley.

Now you can change record-speeds without changing record-speeds.



We've done away with the old turntable speed-control, on this very advanced Philips GA209 record deck.

Simply by placing a record on the turntable the correct speed is electronically chosen and the pick-up lowered gently into the run-in groove.

At the end of the record the turntable stops and the arm returns to the rest.

This facility ensures that both the record and stylus are fully protected.

In manual operation, the pick-up can be positioned over the grooves and lowered by means of a touch control.

The mechanism permits very accurate positioning. Controlled by a servo motor via electronic touch controls, it can be operated whether the deck is used manually or as a fully automatic deck.

Electronic control makes sure that the turntable speed is kept constant.

Separate fine speed controls for 33 1/3 and 45 rpm. allow the record to be tuned to the pitch of any musical instrument.

The photo-electric stop switch is completely soundless and frictionless.

High stability and insulation against shocks and vibration are ensured by the floating suspension of the

turntable and pick-up arm.

The tracking error of the practically frictionless pick-up arm is very small.

Side thrust compensation is adjustable for all playing weights for both spherical and elliptical styli.

The top cartridge from the Super M1 range, the GP412, is supplied as standard.

Shown in manual position to illustrate control panel.

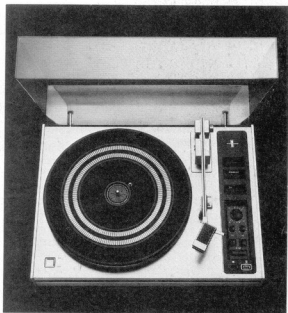

PHILIPS
Simply years ahead

Tekelec's digital multimeters make everything "Liquid Crystal" clear!

PLUS —
a great new idea! Press
the button on Tekelec's
optional "Touch-n-Hold"
probe, and your Tekelec
DMM will take —
and hold — your
readings for you!



TA 355

3^{1/2} Digit Bench Multimeter

- 5 Functions — 25 Ranges !
- High visibility "Liquid Crystal" display includes illuminated function annunciators !
- Fully isolated parallel BCD and battery operation are available !



TA 356

3^{1/2} Digit Portable Multimeter

- 5 Functions — 25 Ranges !
- This extra-low power "Transmissive" Liquid Crystal display is available to extend battery operating time on all of Tekelec's digital multimeters !

Built-in rechargeable batteries and 220 VAC Power Supply/Battery Charger are standard !

All five functions appear automatically inside the display !



TA 365

4^{1/2} Digit Bench Multimeter

- 5 Functions — 25 Ranges !
- Extra-high sensitivity on all five functions — 10 μV, 10 nA, 0.01 ohms !
- BCD output and battery operation are available !

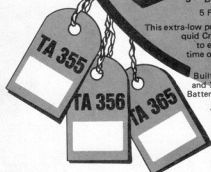

Tekelec's new "Field Effect" Liquid Crystal displays have big, bold, "white-on-black" characters that are easier on the eyes than those "red-hot" numbers that you've been staring at for years !

And Tekelec "Field Effect" Liquid Crystal displays are easier on their driving circuits, too ! Since it takes only a few microwatts to turn on these cool-running displays, Tekelec developed the all-new Poly-Tek™ Analog-to-Digital Conversion System (Pat. Pend.) with custom designed LSI to reduce power consumption, improve accuracy and stability, increase reliability and — best of all — reduce cost !

Every model has its own exclusive features, too ! Both bench instruments have two reading rates, the 3^{1/2} digit multimeters have function annunciators in the displays, and the portable has automatic battery checking circuits to assure measurement accuracy !

Find out for yourself about Tekelec's extra measure of quality, reliability and performance. To get your copy of our new 8 page brochure, just write or call R. GERVAIS at TEKELEC-AIRTRONIC Cité des Bruyères, Rue Carle Vernet 92310 Sèvres (France), Tél.: 626-02-36 (Paris) - Twx : 25997 F. And to see them in person, ask the Tekelec representative or your local authorized distributor for a demonstration. Then you'll say, "get a TEKELEC" too !

TEKELEC TA AIRTRONIC

A brand new portable from Telequipment

The D32 Dual Trace 10 MHz Battery-Operated Oscilloscope

Probably the smallest and least expensive 'scope of its kind in the world. Telequipment's D32 offers a generous performance specification yet remains in the realms of reality where price is concerned. Weighing 10 lb. and only 4 x 9 x 11 inches in size, the robustly built D32 can be carried comfortably on any assignment.

Packed into its tiny frame is a specification with features normally associated with instruments twice its size. Priced at £250* (including rechargeable batteries) this dual-trace 'scope offers 10MHz bandwidth at 10mV/div. sensitivity; automatic selection of chopped or alternate modes; automatic selection of TV line or frame displays; the choice of battery or mains operation and a c.r.t. display covering a very large proportion of its total front panel area.



Write now for full details and demonstration - you won't be disappointed.

TELEQUIPMENT



Tektronix U.K. Ltd.,
Beaverton House, P.O. Box 69, Harpenden, Herts.
Telephone: Harpenden 63141 Telex: 25559

*Provisional price
exclusive of VAT.

ELEKTOR

This is the first English edition of Elektor, a magazine that introduces a new way of presenting electronics.

The Dutch edition of Elektor has been published for over 14 years and the German for over 4. Every month 120,000 copies find their way to readers ranging from enthusiastic amateurs to professional electronic engineers.

Elektor's dynamic and practical application of new electronic techniques has stimulated the ever-present curiosity and imagination of designers. Modern components, active and passive and especially cheap digital and linear integrated circuits, are used in practical designs. Many of the circuits are developed in our own laboratories, and circuit building is greatly facilitated by using the ready-made printed circuit boards we produce for the more important designs.

The availability of components is always considered, and when new components are needed every effort is made to ensure that they can be obtained through the normal retail outlets. On the continent, this practice has led to a modernisation of the retail trade so that now several retailers tend to base their stocks on the information in Elektor publications. This is very good for those firms of course, but it is even better for Elektor readers; it makes available for them a more comprehensive range of components at reduced prices because of the greater demand.

Elektor will not sell components, other than printed circuit boards, so that complete editorial independence is assured. Furthermore, the editorial staff cannot be influenced by advertisers, although it can sometimes influence them where it is important that certain components are made available to our readers.

Elektor has always tried to be dynamic and informative; but it can occasionally irritate, as when it deflates technical imperiousness or indulges in a humorous self-criticism that has given it a 'British' image on the continent.

In 1975, Elektor will appear every two months until August; from September on it will be published monthly. The July/August edition will be a large double issue. On the continent this has become known as the semiconductors guide, and its production is an established tradition.

We shall be working on the first copies for 1975 even as you read this. Articles already accepted describe an electronically-compensated loudspeaker system, a high-quality pre-amplifier, an analogue-digital converter, gyrators, and further developments of the mos-clock, electronic drum and TAP.

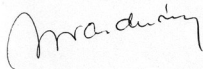

B. W. Van der Horst, editor.

eps print service

Many elektor circuits are accompanied by printed circuit designs. For those who are not inclined to etch their own printed circuit boards, a number of these designs are also available as ready-etched and predrilled boards. These boards can be ordered from our Canterbury office. Payment, including £ 0.15 p & p, must be in advance or by enclosed remittance.

Bank account number: A/C No. 11014587, sorting code 40-16-11 Midland Bank Ltd., Canterbury.

circuit	number	price
distortion meter	1437	£ 1.50
tap sensor	1457	£ 0.55
equa amplifier	1499	£ 1.10
digital rev counter	1590	£ 0.90
mos clock 5314 clockcircuit	1607 A	£ 1.10
mos clock 5314 display print	1607 B	£ 0.80
aerial amplifier	1668	£ 0.85

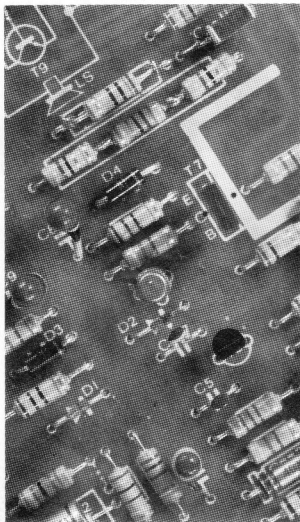

eps print service

ELEKTOR

Volume 1 - number 1

Editor	: W. van der Horst
Deputy editor	: P. Holmes
Editorial	: J. Barendrecht T. Emmens T. Venema
Advertising	: P. Appleyard
Art editor	: C. Sinke
Drawing office	: L. Martin
Subscriptions	: Mrs. A. van Meyel

Elektor will be published every two months until August 1975; from then on it will appear monthly. Copies can be ordered from our Canterbury office. The subscription rate for 1975 is £ 3.60; the first issue (Nov/Dec 1974) will be included in this at no additional cost.

Single copies: £ 0.35, + p & p.

At least four weeks advance notice should be given of any change of address.

Members of the technical staff will be available to answer technical queries (relating to articles published in Elektor) by telephone on Mondays from 14.00 to 16.30.

Letters should be addressed to the department concerned: TQ = Technical Queries; ADV = Advertisements; SUB = Subscriptions; ADM = Administration; ED = Editorial (articles submitted for publication etc.); EPS = Elektor printed circuit board service.

Editorial offices, administration and advertising:
6, Stour Street, Canterbury CT1
2XZ.
Tel. Canterbury (0227) - 54430.

The circuits published are for domestic use only. The submission of designs or articles to Elektor implies permission to the publishers to alter and translate the text and design, and to use the contents in other Elektor publications and activities. The publishers cannot guarantee to return any material submitted to them.

All drawings, photographs, printed circuit boards and articles published in Elektor are copyright and may not be reproduced or imitated in whole or part without prior written permission of the publishers.

contents

introduction	5
from din to equa-standards	8
tip - tun - dug - dus	9
Wherever possible in Elektor circuits, transistors and diodes are simply marked 'TUP', 'TUN', 'DUG' or 'DUS'. This indicates that a large group of similar devices can be used without detriment to the performance of the circuit. In this article the minimum specifications for this group are listed, with tables of equivalent types.	
swinging inductor	12
digital rev counter	12
Until recently, the speed of a car engine (r.p.m.) was measured with an analogue system. It stands to reason that a digital method would do equally well. In principle this can be done with a common frequency meter.	
equa amplifier	16
Literally thousands of circuits for transistor-amplifiers have been developed, all of which were later marketed under the banner of hifi. The brands that meet the Equa-standards laid down in this issue can, however, be counted on the fingers of one - possibly two - hands.	
output power nomogram	22
divide by 1 to 10	23
electronic candle	23
Naturally, the electronic candle can be lit with a match (but a pocket torch will do the job too!); it can be blown out or 'nipped out' with the fingers.	
mos clock 5314	24
The 'brain' in the digital clock described in this article is the clock-IC MM5314, which needs only a few external components. The time of day is indicated by seven-segment Ga-As displays.	
distortion meter	29
The distortion in factory-produced or home-made amplifiers is frequently unknown; designers sometimes give specifications, but these are not always reliable. Since distortion meters are usually expensive, Elektor Laboratories have developed a simple, inexpensive, but effective instrument.	
quadro 1 - 2 - 3 - 4 or nothing?	33
The phenomenon of 'quadrophony' has already been the subject of many publications, but the confusion only seems to increase with every new attempt to clarify the issue. This article may bring a little light into the darkness, by describing and comparing the most important systems that have been proposed so far.	
tunable aerial amplifier	38
The aerial amplifier described in this article is characterized, among other things, by its low noise level (1-2 dB), a voltage gain of 10-20 dB, and a wide tuning range (146-76 MHz).	
tap sensor	43
An important alternative to the mechanical switch - rotating or push-button - is the touch switch. This has the advantages of greater reliability and a higher switching speed, as well as being noiseless and not subject to wear.	
flickering flame	49
The simplest possible flasher device is a bimetal switch. This construction can be found in 'blinker bulbs' and in the starter-switch associated with a fluorescent lamp. The possibility immediately comes to mind of using a fluorescent-lamp starter as a flasher for Christmas-tree or other decorative lights.	
electronic loudspeaker	50
It is widely accepted that the loudspeaker is the weakest link in the high-quality audio chain. This is particularly the case at the lowest working frequencies. The manufacturer has the resources and facilities to tackle the problems at the mechanical-acoustical stage. This article explains that the do-it-yourself approach that provides the best results at the lowest price is invariably the "electronic loudspeaker".	
loudspeaker diagnosis	53
This short article, intended to accompany the 'electronic loudspeaker' in this issue, outlines the way in which a knowledge of the basics of electrical engineering can give access to the 'mysteries of the moving-coil'.	
steam train	56
This article describes a simple method of building an electronic circuit of few components that will produce the sound of a real steam train.	
steam whistle	57
Many model railways still run on 'steam'. For greater realism the steam locomotives are nowadays often fitted with an artificial smoke device. They become even more realistic when an imitation steam whistle is also provided.	

from din to equa-standards

For more than ten years, manufacturers on the Continent have been measuring the quality of record-players, amplifiers, loudspeakers etc. against the West German industrial standard DIN 45500. Products that meet the published standards may be sold as "hifi according to DIN 45500". The editors of Elektor feel it is time to propose a more up-to-date norm.

It seems reasonable to assume that ten years development of, for example, amplifiers should lead not only to extensive miniaturisation but also to an improvement in the quality of components and circuits. This consideration gave the editors of Elektor the idea of checking these DIN standards against the present level of technology. This in turn led to the formulation of the new quality standards that are now offered for discussion.

The basis of the new Equa-standards is as follows:

It must be possible in a sitting room to play back music with a recorded dynamic range of 40 dB which implies a required signal-to-noise ratio of at least 50 dB and preferably 60 dB.

The level of background noise in the sitting room is taken to be about 32 dB (sound pressure level); for headphone listening 20 dB SPL.

The following standards can now be proposed:

1. The (minimum) output power of an amplifier, for use in a typical sitting room with typical loudspeakers, should be 10 watts; the equipment must be able to maintain this power level continuously for at least 10 minutes. This requirement is the same as the DIN standard.
2. The output power of an amplifier, driving the least sensitive headphones

should be at least 0.2 watts; more sensitive units can however often manage with 1 milliwatt.

3. The signal-to-noise must be at least 50 dB; one should aim at 60 dB. When a volume control is fitted, these requirements should also be met when this control is set at -20 dB. The DIN standard in this case specifies 50 dB or better.
4. The frequency response curve should be flat within 1.5 dB from 40 Hz to 16 kHz; in agreement with DIN. Moreover, the curve must remain 'smooth' outside these limits, although it may roll off gradually.
5. The peak amplitude (not RMS!) of harmonic distortion must be less than 0.3%; one should aim at 0.1%. DIN lays down a harmonic maximum distortion of 1% RMS. This is a) too high and b) meaningless! (See the article "Equa-amplifier").
6. The intermodulation distortion (measured as specified by DIN) should be less than 1% rather than the present 3%.
7. The stability must be unconditional, with any load. (The DIN standard says nothing about this.)
8. No damage may be caused (other than blown internal fuses!) by overdriving an input up to 20 dB (10x) or by operating the output with a short or

open circuit or with a reactive (including inductive) load. (This is not mentioned in the DIN standard.)

9. The crosstalk between different inputs must be at least 50 dB down from 100 Hz to 10 kHz; preferably 60 dB. The DIN requirement is 40 dB.
10. The suppression of crosstalk between a pair of stereo-channels must be at least 40 dB from 250 Hz to 10 kHz (DIN standard 30 dB).

The table compares the requirements and designer's-aim values according to the Equa-standard with the DIN 45500 requirements.

These standards were first presented by Elektor on the continent in 1972 as a starting-point for further discussion. It has since then become apparent that the usefulness of an IM distortion measurement (point 6) and the requirements for stereo crosstalk suppression (point 10) give rise to some queries.

In addition, a need is felt for a relatively simple and precise measurement of transient distortion and transient intermodulation distortion (slope overload, slew-rate limiting).



	Equa-standard		DIN
	Requirement	Design aim	
Output power mono	10 watt	40 watt	10 watt
stereo	2 x 10 watt	2 x 20 watt	2 x 6 watt
Signal to noise	50 dB	60 dB	50 dB
Response ± 1.5 dB	40 Hz to 16000 Hz	Ditto	Ditto
Harmonics peak level	0.3%	0.1%	—
Harmonics RMS level	—	—	1%
Intermodulation	1%	0.3%	3%
Stability complete:			
resistive load	0 - infinite	Ditto	—
capacitive load	10 pF - 10 μF	Ditto	—
Withstands +20 dB	10 min.	Ditto	—
Withstands load fault	10 min.	Ditto	—
Crosstalk between:			
different inputs	50 dB	60 dB	40 dB
stereo-pair	40 dB	Ditto	30 dB

The requirements and designer's-aim values according to the Equa-standard, in comparison with the requirements laid down in DIN 45500. These standards apply to quality-amplifiers intended for use in domestic listening rooms.

tup-tun-dug-dus

Wherever possible in Elektor circuits, transistors and diodes are simply marked 'TUP', 'TUN', 'DUG' or 'DUS'. This indicates that a large group of similar devices can be used without detriment to the performance of the circuit.

In this article the minimum specifications for this group are listed, with tables of equivalent types. Also described are several simple measuring procedures that make it possible to find the connections and approximate performance of an unmarked device.

As far as possible, the circuits in Elektor are designed so that they can be built with standard components that most retailers will have in stock.

It is well-known that there are many general purpose diodes and low frequency transistors with different type numbers but very similar technical specifications. The difference between the various types is often little more than their shape. This family of semiconductors is referred to in the various articles by the following abbreviations:

TUP = Transistor, Universal PNP,

TUN = Transistor, Universal NPN,

DUG = Diode, Universal Germanium,

DUS = Diode, Universal Silicon.

TUP, TUN, DUG and DUS have to meet certain minimum specifications - they are not just 'any old transistor' or 'any old germanium diode' The minimum specifications are listed in tables 1a and 1b. It is always possible, of course, to use a transistor with better specifications than those listed!

Simple measurements

It is advisable only to use semiconductors with a clearly legible type number, and with known specifications. However, transistors without a type number are often cheaper, and some simple tests can give an indication of their value.

The first test serves to find out whether the transistor is a PNP or an NPN type,

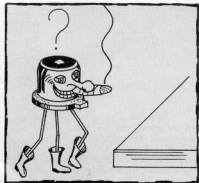
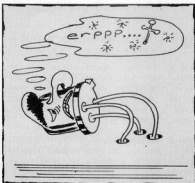
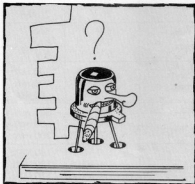

and to locate the base connection. A multimeter is used, switched to the lowest resistance scale. The plus lead of the meter is connected to one of the pins of the transistor (figure 1a).

The minus lead is then touched to each of the other transistor pins in turn. If the meter shows a low resistance in both cases the transistor is probably a PNP type, and the plus lead from the meter is connected to its base. If the meter shows a low resistance at only one of the two remaining pins the transistor is probably an NPN type, and the minus lead from the meter is connected to its base.

If the meter doesn't show a low resistance in either case, the plus lead from the meter should be connected to one of the other two pins and the procedure repeated.

Having located the base connection and the probable type (PNP or NPN), a double check can be made according to figure 1b. For an NPN type, the minus lead from the meter is connected to the base and the plus lead is touched to each of the other connections in turn. The meter should show approximately the same (low) resistance value for both cases. After reversing the connections to the meter, the same test should show a very high resistance (little or no deflection) for both cases. For a PNP type, the first two measurements should show a high resistance and the second two should show a low resistance.

The next step is to locate the emitter and collector connections. The multimeter is now switched to the highest resistance scale and the test leads are connected to the two remaining transistor pins (the base is not connected). If the transistor is an NPN type and the meter shows a very high resistance (figure 1c), the minus lead is connected to the collector and the plus lead is connected to the emitter. On reversing the connections (figure 1d) a relatively low resistance value should be indicated. If the transistor is a PNP type, the measurement results are reversed.

If any of the tests show zero resistance between two pins of the transistor, there

Table 1a.

	type	U_{ce0} max	I_c max	h_{fe} min.	P_{tot} max	f_T min.
TUN	NPN	20 V	100 mA	100	100 mW	100 MHz
TUP	PNP	20 V	100 mA	100	100 mW	100 MHz

Table 1b.

	type	U_R max	I_F max	I_R max	P_{tot} max	C_D max
DUS	Si	25 V	100 mA	1 μ A	250 mW	5 pF
DUG	Ge	20 V	35 mA	100 μ A	250 mW	10 pF

Table 2.

TUN		
BC 107	BC 208	BC 384
BC 108	BC 209	BC 407
BC 109	BC 237	BC 408
BC 147	BC 238	BC 409
BC 148	BC 239	BC 413
BC 149	BC 317	BC 414
BC 171	BC 318	BC 547
BC 172	BC 319	BC 548
BC 173	BC 347	BC 549
BC 182	BC 348	BC 582
BC 183	BC 349	BC 583
BC 184	BC 382	BC 584
BC 207	BC 383	

Table 3.

TUP		
BC 157	BC 253	BC 352
BC 158	BC 261	BC 415
BC 177	BC 262	BC 416
BC 178	BC 263	BC 417
BC 204	BC 307	BC 418
BC 205	BC 308	BC 419
BC 206	BC 309	BC 512
BC 212	BC 320	BC 513
BC 213	BC 321	BC 514
BC 214	BC 322	BC 557
BC 251	BC 350	BC 558
BC 252	BC 351	BC 559

Table 4.

DUS		DUG
BA 127	BA 318	OA 85
BA 217	BAX 13	OA 91
BA 218	BAY 61	OA 95
BA 221	1N914	AA 116
BA 222	1N4148	
BA 317		

Table 5.

	NPN	PNP
	BC 107 BC 108 BC 109	BC 177 BC 178 BC 179
V_{ce0} max	45 V 20 V 20 V	45 V 25 V 20 V
V_{eb0} max	6 V 5 V 5 V	5 V 5 V 5 V
I_c max	100 mA 100 mA 100 mA	100 mA 100 mA 50 mA
$P_{tot.}$ max	300 mW 300 mW 300 mW	300 mW 300 mW 300 mW
f_T min.	150 MHz 150 MHz 150 MHz	130 MHz 130 MHz 130 MHz
F max	10 dB 10 dB 4 dB	10 dB 10 dB 4 dB

The letters after the type number denote the current gain:

- A: α' (β , h_{FE}) = 125-260
 B: α' = 240-500
 C: α' = 450-900.

Table 1a. Minimum specifications for TUP and TUN.

Table 1b. Minimum specifications for DUS and DUG.

Table 2. Various transistor types that meet the TUN specifications.

Table 3. Various transistor types that meet the TUP specifications.

Table 4. Various diodes that meet the DUS or DUG specifications.

Table 5. Minimum specifications for the BC107, -108, -109 and BC177, -178, -179 families (according to the Pro-Electron standard). Note that the BC179 does not necessarily meet the TUP specification ($I_{c,max} = 50$ mA).

Table 6. Various equivalents for the BC107, -108, ... families. The data are those given by the Pro-Electron standard; individual manufacturers will sometimes give better specifications for their own products.

Table 6.

NPN	PNP	Case	Remarks
BC 107 BC 108 BC 109	BC 177 BC 178 BC 179		
BC 147 BC 148 BC 149	BC 157 BC 158 BC 159		$P_{max} = 250$ mW
BC 207 BC 208 BC 209	BC 204 BC 205 BC 206		
BC 237 BC 238 BC 239	BC 307 BC 308 BC 309		
BC 317 BC 318 BC 319	BC 320 BC 321 BC 322		$I_{c,max} = 150$ mA
BC 347 BC 348 BC 349	BC 350 BC 351 BC 352		
BC 407 BC 408 BC 409	BC 417 BC 418 BC 419		$P_{max} = 250$ mW
BC 547 BC 548 BC 549	BC 557 BC 558 BC 559		$P_{max} = 500$ mW
BC 167 BC 168 BC 169	BC 257 BC 258 BC 259		169/259 $I_{c,max} = 50$ mA
BC 171 BC 172 BC 173	BC 251 BC 252 BC 253		251 ... 253 low noise
BC 182 BC 183 BC 184	BC 212 BC 213 BC 214		$I_{c,max} = 200$ mA
BC 582 BC 583 BC 584	BC 512 BC 513 BC 514		$I_{c,max} = 200$ mA
BC 414 BC 414 BC 414	BC 416 BC 416 BC 416		low noise
BC 413 BC 413	BC 415 BC 415		low noise
BC 382 BC 383 BC 384			
BC 437 BC 438 BC 439			$P_{max} = 220$ mW
BC 467 BC 468 BC 469			$P_{max} = 220$ mW
	BC 261 BC 262 BC 263		low noise

Figure 1. A simple method of finding the type (PNP or NPN) and the base, emitter and collector pins of an unknown transistor.

Figure 2. A simple method for estimating the current amplification factor of an unknown transistor.

tup tun dug dus

is an internal short circuit in the transistor. It is then sometimes suitable as a diode, but usually can only be used as a very elegant kind of jumper wire

It should be noted that in all the above tests the positive lead from the meter is the one connected to the terminal marked '+'. In practice the voltage on this terminal is negative with respect to the terminal marked '-', when the multi-

types ($V_{ce0} = 45$ volts) and the BC109/BC179 are low-noise. If these differences are not important in a particular circuit, the various types are interchangeable.

The code letters A, B or C after the type number on these transistors denote various current amplification factors. For the A-types this is from 125 to 260, for the B-types it is 240 to 500 and for the C-types 450 to 900. A BC109C is

therefore not a direct equivalent for a BC109B, for instance, although in many practical circuits it will make little or no difference.

When using the equivalent types BC167, -168, -169, BC257, -258, -259 or BC467, -468, -469 it should be noted that the base, emitter and collector leads are in a different order (see table 6).

M

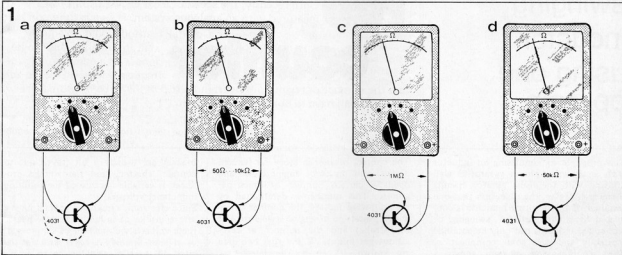

meter is switched to resistance measurement. The measuring procedure is based on this polarity inversion.

An indication of the current gain of the unknown transistor can be found in a similar way (figure 2). The multimeter is switched to the highest resistance scale, the plus lead is connected to the emitter and the minus lead to the collector (if the transistor is an NPN type; otherwise the connections are reversed). If the previous tests were carried out correctly, the meter should show a fairly high resistance.

The collector and base connections are now bridged with one finger, so that current flows via the skin resistance to the base of the transistor under test. The meter should now register a fairly low resistance. The higher the current gain (and the lower the skin resistance!) the lower the indicated resistance value will be. A comparative measurement with a transistor of known quality will give an indication of whether or not the 'measured' current gain was sufficient.

Specifications and equivalents

A number of transistor types that meet the TUN specifications are listed in table 2. This list is, of course, incomplete - there are far more possible types. Table 3 lists a number of possibilities for use as TUP, while table 4 gives equivalents for DUG and DUS.

A further group of better quality transistors are the BC107 - BC108 - BC109 (NPN) and BC177 - BC178 - BC179 (PNP) families. The minimum specifications are listed in table 5, while table 6 gives a list of equivalents. As will be obvious from the specifications, the main differences between the types are that the BC107/BC177 are higher voltage

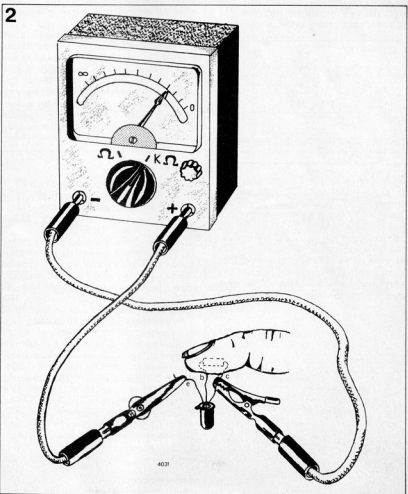

swinging inductor using one op-amp

The principle of simulating an inductor with a capacitor plus a gyrator is well known. With the usual gyrator circuits there is, however, the objection that one terminal of the resulting inductor is connected to circuit earth. A 'swinging' or free-ended inductor can only be obtained indirectly and with some complication. The accompanying diagram shows a swinging inductor that requires two capacitors and one operational amplifier. The inductance appearing between points A

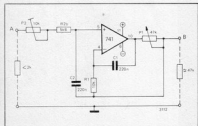

and B is given by $L = P1 \times \tau$, where $\tau = R1 \times C1 = (R2 + P2)C2$. $P2$ will determine the 'Q' factors.

The rules of the game are: the external impedance between point A and circuit earth must be less than $2 \text{ k}\Omega$, while the load on point B must be roughly equal to the value of $P1$ ($47 \text{ k}\Omega$ in this case). With the values given in the circuit diagram, the inductance obtained is variable over a range of approximately $1 \dots 100$ Henries!

digital rev counter

Until recently, the speed of a car engine (r.p.m.) was measured with an analogue system. It stands to reason that a digital method would do equally well. In principle this can be done with a common frequency meter. Since in this case the number of revolutions per minute (r.p.m.) is to be measured, the time base will have to be somewhat adapted.

The contact breaker in every car (except diesels) and on every engine closes and opens a certain number of times per minute. This number is determined by the following factors: the number of cylinders, the type of engine (two-stroke or four-stroke) and the number of revolutions per minute. If the first two data are known, it can be calculated how many pulses a certain contact breaker gives per second at a certain number of revolutions per minute.

A one-cylinder two-stroke engine gives one pulse per revolution. A one-cylinder four-stroke engine produces one pulse per two revolutions. So a four-stroke engine gives half the number of pulses at the same number of revolutions. This leads to the formula for the number of pulses per second any type of engine produces at a certain number of revolutions (per minute):

$$p = \frac{n \times c}{60 \times a}$$

where p =	pulses per second (p.p.s.)
n =	revs per minute (r.p.m.)
c =	number of cylinders
a =	1 for two-stroke, 2 for four-stroke.

By means of this formula we can now set up Table 1 which immediately shows the fixed r.p.m./p.p.s. ratio for each type of engine. For instance, a most common engine is the four-cylinder four-stroke. At 6000 r.p.m. this engine produces 200 p.p.s. To express the r.p.m. in four digits will therefore take some 30 seconds. This is, of course, out of the question because within the time span of 30 seconds the number of r.p.m. is subject to variation. Consequently, the number of digits shown is reduced to two. The measuring time is then only three tenths of a second. The engine speed can thus be measured with an accuracy of $< 1\%$, which is amply sufficient. Nobody will care whether an engine makes 3418 or 3457 r.p.m.

The circuit

The pulses produced by the contact

breaker are usually a bit frayed due to contact 'chatter', and the voltage produced is variable because of the resulting inductance voltages.

Since electronic circuits in general have a severe dislike of inductive voltage peaks, these voltages will have to be suppressed, or at least limited. A zener with a capacitor in parallel for the sharp peaks provides sufficient protection. This protective network is formed by R_1 , C_1 and D_1 (see figure 1). Thus the inductive peaks, and to some extent also contact chatter, are suppressed. The remaining chatter is suppressed by means of a monostable multivibrator, which uses half of a 7400 IC. This one-shot responds to pulses with a width of $50 \mu\text{s}$ or more. In addition, the one-shot passes pulses wider than the characteristic pulse time for their entire length, so that spurious pulses have no effect.

The timebase is provided by a simple, yet relatively stable UJT-oscillator. Its pulse width can be adjusted over a wide range by means of potentiometers R_5 and R_6 ; the first is for coarse adjustment, the second for fine. In some cases the value of R_7 must be changed (larger or smaller) to enable the required pulse width to be set.

In contrast to the usual circuits, the output pulse is not used to drive a counter gate. The signal to be counted is fed continuously to the counter input of the digital counter used. This is possible because the measuring time is so long that the measuring error due to the latch-and-reset time is negligible.

The signal for the buffer memory used in the counter is derived from the discharge pulse the UJT produces across R_9 . The transistors T_3 and T_4 provide a level suitable for TTL circuits.

The latch signal thus obtained is a positive pulse. The negative edge of this pulse is used for triggering a one-shot, so that a reset pulse can be produced after the latch pulse. The decade counter, type 7490 (generally applied in digital counters) must be reset with a positive pulse. However, the one-shot produces a negative pulse. Moreover, the delay

between latch and reset is too small to ensure optimum functioning. Therefore, the positive trailing edge of the negative pulse is used. After differentiation with C_5 and R_{15} a useful signal appears on the reset output. Diode D_2 suppresses the differentiated pulse caused by the negative flank.

So far the overall control circuit. Its layout is shown in figure 2.

In principle any digital decade counter can be used, and one that is eminently suitable is the minitron counter. This decade counter consists of a display board with several counter boards mounted at right angles to it. For this application the display board is shortened to about 5 cm, so that it can accommodate only two minitrons. The complete minitron counter with two decades is then a block of no more than 5×6.5 cm. The dimensions of the control circuit board are reduced correspondingly.

The diagram of the minitron counter is

shown in figure 3. The 7490 is connected as a normal divide-by-ten circuit. The buffer memory, or latch, is a 7475. This IC contains four D-flipflops that store the information from the 7490 or pass it on continuously, as required. When mounting the IC on the board, pin 8 must be cut off; or, if IC sockets are used, pin 8 can be removed from the IC socket.

Via the 7475, the BCD information is fed to the 7-segment decoder 7447 which drives the minitron directly. The board is shown in figure 4. By means of soldered connections the display and counter circuit boards are joined to form a kind of block. Figure 5 shows how and where the soldered connections must be made. The width of the control board matches that of the counter boards so that that, too, can be soldered to the display board.

Supply

The rev. counter operates on the usual voltage for TTL-ICs, that is 5 V.

Figure 1. Circuit diagram of the control circuit.

Figure 2. Printed circuit board and component lay-out for the control circuit.

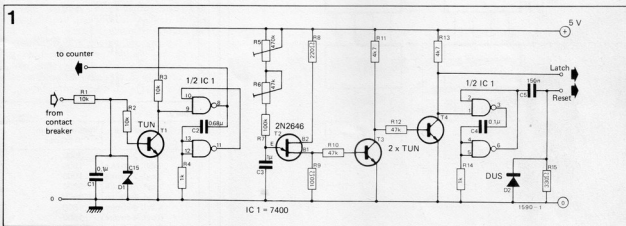

Parts list

Resistors:

$R_1, R_2, R_3 = 10 \text{ k}$
 $R_4, R_{14} = 1 \text{ k}$
 $R_5 = 470 \text{ k, trim.}$
 $R_6 = 47 \text{ k, trim.}$
 $R_7 = 100 \text{ k}$
 $R_8 = 220 \Omega$
 $R_9 = 100 \Omega$
 $R_{10}, R_{12} = 47 \text{ k}$
 $R_{11}, R_{13} = 4 \text{ k}$
 $R_{15} = 330 \Omega$

Capacitors:

$C_1, C_4 = 0.1 \mu$
 $C_2 = 0.68 \mu$
 $C_3 = 1 \mu$
 $C_5 = 150 \text{ n}$

Semiconductors:

$T_1, T_3, T_4 = \text{TUN}$
 $T_2 = 2\text{N}2646 \text{ (UJT)}$
 $\text{IC} = 7400$
 $D_1 = \text{zener } 15 \text{ V, } 250 \text{ mW}$
 $D_2 = \text{DUS}$

2

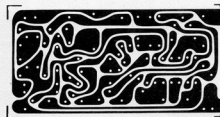
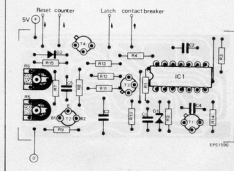

Table 1.

Engine type	Pulses per second	
	6000 r.p.m.	8000 r.p.m.
1 cyl. 2-stroke	100	133
2 cyl. 2-stroke	200	267
3 cyl. 2-stroke	300	400
1 cyl. 4-stroke	50	67
2 cyl. 4-stroke	100	133
4 cyl. 4-stroke	200	267
6 cyl. 4-stroke	300	400
8 cyl. 4-stroke	400	533



Adjustment

There are several ways of adjusting the rev. counter. The most accurate method is by using the mains frequency or a crystal time base. Unfortunately, the latter will not always be available.

Another possibility is to use a tone generator. Both mains frequency - and tone generator adjustment are discussed below.

Adjustment with the tone generator

For this method of adjustment, a tone generator with calibrated tuning scale for reasonable accuracy is a first requirement. Table 1 gives the frequencies corresponding to a certain type of engine running at 6000 or 8000 r.p.m. Furthermore, each frequency corresponding to a certain engine speed can be calculated

with the formula given above. So far so good.

However, the circuit responds only to square wave voltages, so the tone generator will have to produce a square-wave output, or the conventional sine-wave must be converted into a square wave.

This can be done with the simple circuit

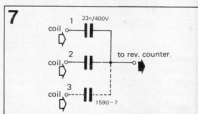
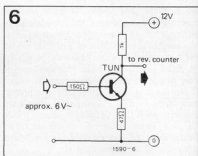
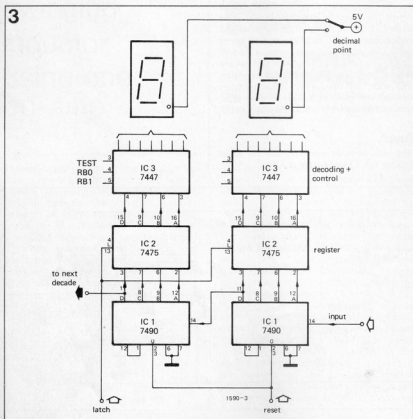
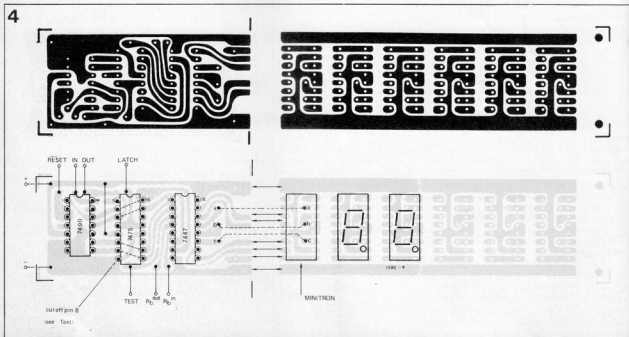

Table 2.

Engine type	rpm indication at 50 pps
1 cyl. 2-stroke	3000
2 cyl. 2-stroke	1500
3 cyl. 2-stroke	1000
1 cyl. 4-stroke	6000
2 cyl. 4-stroke	3000
4 cyl. 4-stroke	1500
6 cyl. 4-stroke	1000
8 cyl. 4-stroke	750



in figure 6. The output signal of this circuit is about 10 V, which is sufficient to operate the rev. counter.

Adjustment with mains frequency

Here again the auxiliary circuit of figure 6 is used, for the mains voltage is a sine wave. A simple bell transformer, or something similar, will provide the required voltage of 6 V.

The square wave output from the circuit is applied to the input of the control circuit.

Table 2 shows what the rev. counter should indicate when used with a given type of engine, and operating on a 50 Hz input signal. While the input signal is applied, the counter can be accurately adjusted by means of R_5 and R_6 . Adjustment must be such that the reading fluctuates as little as possible between various values. As is usual for most digital counters, the last digit can jump plus or minus one.

Engines with several ignition coils

Some engines have more than one ignition coil and contact breaker. In this case the various channels from the contact points should be coupled with capacitors. Figure 7 shows how this is best done. A little of experimenting may sometimes be necessary to find the best values for the capacitors.

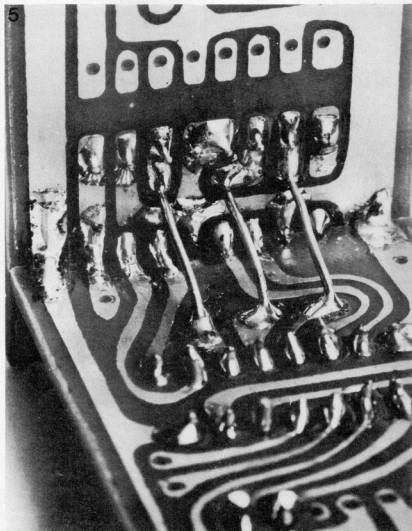
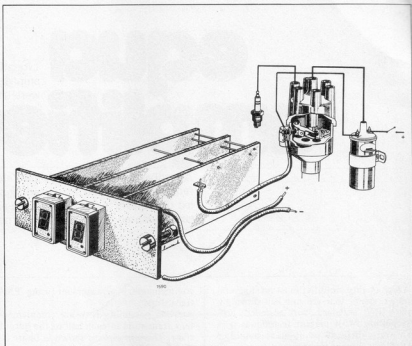

Figure 3. Circuit diagram of the minitron decade.

Figure 4. Printed circuit board and component lay-out for counter plus display. For this particular application the display board can be shortened to about 5 cm.

Figure 5. The photograph shows clearly how the soldered connections between the two boards must be made.

Figure 6. Auxiliary circuit for adjusting the rev. counter by means of a tone generator or with the mains frequency.

Figure 7. If the engine has more than one ignition coil, this auxiliary circuit can be used to obtain a correct speed indication.

equa amplifier

Literally thousands of circuits for transistor-amplifiers have been developed, all of which were later marketed under the banner of Equi.

The brands that meet the Equi-standards laid down in this issue can, however, be counted on the fingers of one — possibly two — hands.

A feedback loudspeaker system ('electronic loudspeaker') places very strict requirements on the associated amplifier. This consideration, among others, led the editors to develop an equa-amplifier, with a circuit that could be easily adapted to give any output power up to 100 Watts.

A high quality amplifier must meet several requirements that are not laid down by the DIN standard for so-called hi-fi-amplifiers. With present techniques it is not very difficult to build an amplifier to satisfy these requirements.

Quality requirements

In the first place, the amplitude-frequency response curve of an amplifier should be flat over the entire audio-range, say from 30 to 20000 Hz. Outside this range the curve must remain 'smooth', which is actually the result of meeting a requirement placed upon the phase-frequency response inside the range. (This latter point is the vital one; but the amplitude curve is easier to measure). A rolloff slope of, say, 12 dB/octave below 30 Hz and above 20 kHz will not in itself influence the quality. (It will frequently prevent subsonic or ultrasonic overdriving, and produce an audible improvement.)

Secondly, the distortion must be so low that it cannot be detected by ear. The threshold for this is typically 0.5 to 1%. A problem here is that our hearing responds to the amplitude (i.e. peak level) of a distortion component and not to its RMS level. Therefore, the amplitude of any distortion component must remain below 0.5%. The usual distortion measurement gives the RMS result of all unwanted components; this does not always give a meaningful, never mind accurate, impression. We will return to this point in a moment.

Finally, we must also set up a requirement about reliability. This can be summed up in general terms as follows: the amplifier must be unconditionally stable, with any load; it must also be protected internally against overdriving, excessive loading and voltage surges by inductive loads.

The output stage

In principle, output stages can be built in many ways. With two or more transistors, a super-emitter-follower, the so-called Darlington pair, can be made. In figure 1a this is shown for two NPN transistors; figure 1b shows the perfectly

complementary arrangement using PNP transistors.

Another possibility is to use complementary transistors in each half of the output stage. This principle is shown in figure 2a with an NPN power transistor, and in figure 2b with a PNP power device. These circuits can be seen as amplifiers with fairly high open-loop gain, using 100% negative feedback to achieve a voltage gain of unity. This behaviour resembles that of an emitter-follower; the performance is however rather better, particularly with small signals.

A very popular output stage configuration is the combination of figure 1a with figure 2a to form the 'quasi-complementary' arrangement. This has the advantage that the power transistors are identical NPN types, which are usually easier and cheaper to get hold of than their PNP complements. It has the serious disadvantage, however, that the two halves are not really complementary — which invariably causes increased distortion.

The half stages of figures 1a and b — two Darlington arrangements — can be combined to provide a perfectly complementary circuit. The combination of figures 2a and 2b is, however, the preferred arrangement. The individual circuits themselves are better than Darlington's, and the complete output stage is also complementarily symmetrical. This arrangement therefore was chosen for the Equa-amplifier.

The Law of Cussedness requires that this circuit should also have objectionable aspects. Well, it has. One practical objection is that the output is taken from the power-transistor collectors, which means that the device cooling surfaces carry audio voltage. To avoid stability problems the transistor must be insulated by mica washers, and the heatsink itself should be connected to circuit earth.

Crossover distortion

The distortion in a power amplifier is usually determined by the output stage. One well-known effect is (primary) crossover distortion. This occurs with class B

output stages in the neighbourhood of zero-crossing of the signal waveform. Both halves of the stage are then operating in the non-linear area close to cut-off. To avoid distortion it must be arranged that the stage-gain (actually its transconductance) does not vary with the position on the signal waveform. At greater excursions one half of the output stage is amplifying and the other is cut off. The active half will show its ultimate value of transconductance (or 'slope') over most of its working range.

If the stage is sufficiently symmetrical, the ultimate slope will be essentially the same for both directions of swing. In the 'crossover' region near the zero-crossings both stage halves will conduct. This can lead to three situations (see figure 3): the sum of the two slopes can be greater, less than or equal to the ultimate slope of one half stage during greater excursions. Clearly, it is the third situation that is required for minimum distortion. This condition is most closely approached by arranging that both sections amplify with half their ultimate slope at the actual point of zero crossing. This is achieved by, among other things, setting the correct value of standing ('quiescent') current.

Secondary crossover

Less well-known is the so-called secondary crossover distortion. This is caused by charge-storage in the bases of, mainly, the output transistors. The effect is that the output sections 'cut off too late' and 'turn on too late'. It produces short distortion notches, shown for one half stage in figure 4 (exaggerated for clarity). This distortion is virtually ignored by the 'normal' distortion measurement!

The DIN standard specifies a measurement of the RMS value of the total of distortion products. Suppose now that the amplitude of these notches is 5% (!) of the signal amplitude. This is distinctly audible. During each cycle there will be only two notches, which are very short. Suppose now that the total notchtime is one fiftieth of a cycle.

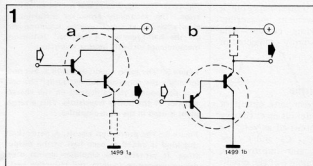

An RMS measurement now gives the effective value as a proportion of the total effective value — less than 0.1%. Such an amplifier therefore meets the hifi-standards and may be sold as a hifi instrument. But a high-quality amplifier it is not! In the Equa-amplifier certain precautions are taken to keep this kind of distortion as low as possible.

A first good step in this direction is to introduce low-value resistors between base and emitter of the output transistors. This allows the charge to flow off more quickly.

After this, compensation networks are inserted in the emitter circuits of the driver transistors. These networks are designed to simulate the output transistor's base-emitter junction with its shunt resistor.

One half of the output stage then has the circuit shown in figure 5. The choice of diode and other components depends on the properties of the associated power transistor. The idea is to select the values so that, provided an output transistor of the specified type is used, the worstcase total amplitude of the distortion will be less than 0.1%. Using good instruments it is possible to trim up an individual amplifier to about 0.01%! One must, however, have access to a good distortion-

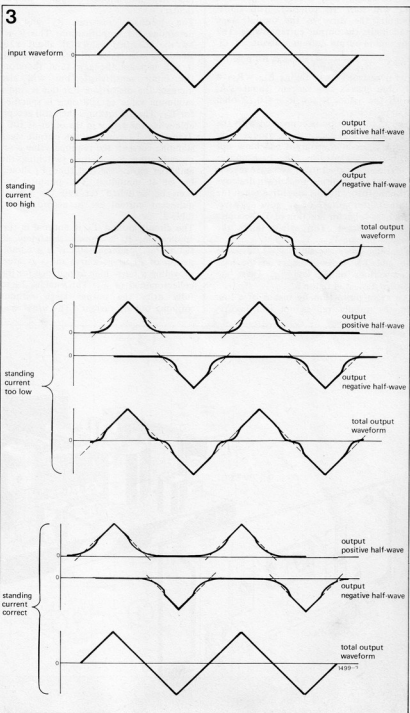
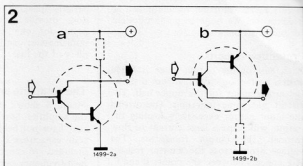

Figure 1. The Darlington circuit for one half of an output stage. It can be built up using two NPN (a) or two PNP (b) transistors.

Figure 2. An alternative circuit for output stage-halves. One half is built up using a PNP followed by an NPN, vice versa.

Figure 3. Three possible cross-over characteristics, depending on how the output transistors are biased. The output signal is always the sum of the signals from the two stage-halves.

meter, a low-distortion oscillator and an oscilloscope. We hope to publish designs for such instruments shortly.

Protection circuits

Each half of the output stage is fitted with a protection circuit. Figure 6 shows the arrangement for the upper half. The circuit has three functions. Overdriving the input and/or excessively loading the output will cause a large current to flow through the output transistors. The voltage drop across the emitter resistor R_{16} appears between the points B and C. If this voltage drop exceeds about 1 volt, T_6 will start to conduct. This short-circuits the drive to the output stage and limits the output current swing. The maximum output current is about

$$I_{\max} = \frac{1}{R_{16} \text{ (or } R_{17})} \text{ ampères for positive (or negative) swing. Taking } R_{16} = R_{17} = 1 \text{ ohm makes this current about 1 A; with the values } R_{16} = R_{17} = 0.22 \text{ ohm it approaches 5 A.}$$

The third function is connected with the experience that back e.m.f.s. produced by inductances at the output can blow out the driver transistors; the base-emitter junction is exposed to an excessive reverse bias and the resulting breakdown destroys the transistor. In this amplifier, when the base-emitter voltage of T_8 goes negative, the base-collector junction of T_6 becomes forward-biased. This safely limits the reverse bias on T_8 .

For high-power versions it is advisable to add 1 k series resistors in the base connections of T_5 and T_6 . These are shown dashed in figure 8.

An extra protection by means of a fuse in the supply rail is not just luxury.

Strictly speaking it is unnecessary, but it does provide a convenient measuring-point for the standing current. The milliammeter can be simply connected in place of the fuse.

The complete amplifier

Figure 8 shows the complete circuit of the amplifier. Several details meet the eye that have not been discussed as yet. The four capacitors C_4 , C_5 , C_6 and C_7 are included to control and improve the high-frequency performance of the circuit (stability and impulse response in particular).

The feedback resistors R_5 and R_6 determine the amplification. This is set by the specified values at about $\times 20$. Reducing the value of R_5 is allowed; it will increase the gain (and therefore the input sensitivity!) but will also increase the distortion. For this reason a minimum value of 100 ohm is specified for R_5 . The distortion is then still acceptable while the gain is in the order of 100. Transistor T_2 controls the output stage standing current; the required value is set by adjusting P_2 . Before switching the amplifier on for the first time, P_2 should be set at minimum. The amplifier can then be switched on and the correct quiescent current set in accordance to table 2.

The circuit around T_4 is unusual in this application. It is shown separately in figure 7a. Fundamentally it is a combination of a current-source and a gyrator, providing a fairly high impedance for the collector load of T_3 . This enables T_3 to fully drive the output stage without 'running out of current'. The usual way

Figure 4. The signal from one half of an output stage. The secondary crossover distortion is clearly visible as small notches superimposed on the half-sinewave. A 'normal' distortion-measurement virtually ignores this effect.

Figure 5. The same circuit as figure 2, but now including the compensation-networks. The correct component values depend on the characteristics of the power transistors. This arrangement is used in the equa-amplifier.

Figure 6. The protection circuit. A network of this kind is added to each half of the output stage. It protects the amplifier against overdriving, excessive loading and inductive back-voltages at the output.

Figure 7. To achieve a high collector feed-impedance for the pre-driver transistor T_3 the combination of gyrator and current-source shown in figure 7a may be used. The classic solution is 'bootstrapping' as shown in figure 7b. We believe the first circuit is preferable, but the circuit board can be used with either.

Figure 8. The complete amplifier. With the specified power transistors the maximum output power rating is about 100 watts into 4 ohms. The compensation network is designed to match these transistors.

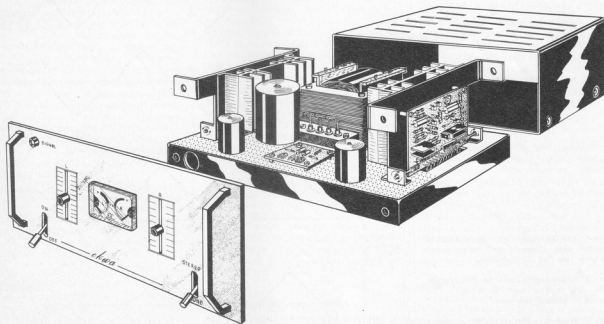

4

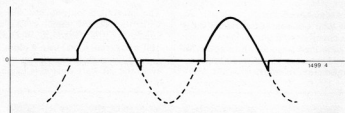

6

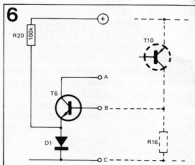

5

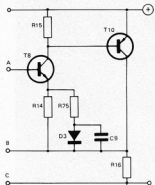

7

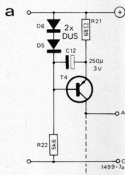

b

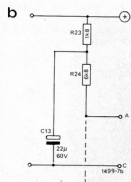

8

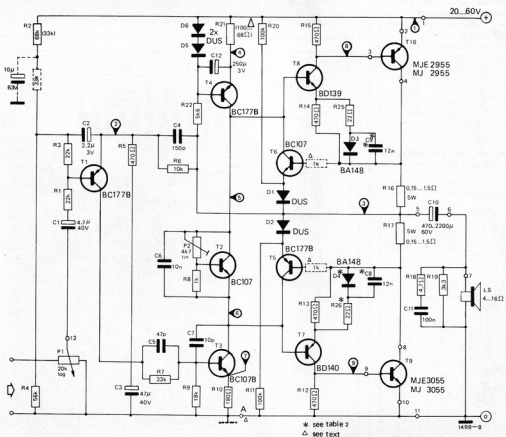

* see table 2
 △ see text

of providing this high impedance is the 'bootstrap' circuit shown in figure 7b. This latter circuit can be expected to have a greater instability-risk; but practical experience has yet to demonstrate any difference. The circuit board is suitable for either arrangement although, in our opinion, figure 7a is preferable.

Finally, the loudspeaker connection is paralleled by a network consisting of R_{18} , R_{19} and C_{11} . This guarantees the stability of the amplifier when it is operated without a load.

The proof of the pudding . . .

Several amplifiers were built according to this recipe, using randomly-chosen components. The worst-case measurement results were as follows:

Amplitude-frequency response curve flat within 1 dB from 20 Hz to 60 kHz.

Peak distortion level below 0.07% (typ. 0.03%).

Stability maintained for:

resistive load (all values from dead short to open circuit),
capacitive load from 10 pF to 1000 μ F,
inductive load from 10 μ H to 200 mH,
any combination of values.

Output power

The maximum output can be selected with the aid of table 1. As will be apparent, the absolute maximum is 100 watts (sine wave) into 4 ohms. For all normal listening in the sitting room however, the 20 watt version is emphatically

Table 1. The required supply voltages and values of R_{16} and R_{17} , for various loudspeakers (nominal) impedances and output power ratings.

Output power (watt)	Loudspeaker impedance (ohm)	Supply voltage (volt)	R_{16} , R_{17} (ohm)
10	4 16	42	0.47
20	4 16	60	0.33
40	4 8	60	0.22
70	4 5	60	0.18
(100)	4	60	0.15)

Table 2. A number of possible compensation networks, suitable for power transistors MJ(E) 2955/MJ(E)3055.

D ₃ ,D ₄	R_{25} , R_{26}	C_8 , C_9	Quiescent current	Remarks
1N4002	0 Ω	27 n	25 mA	recomm.
BA 148	22 Ω	12 n	25 mA	suitable
BY 127	10 Ω	x	40 mA	possible

Table 3.

Test points (fig. 8)			
1	60	40	20
(R_{21})	100 Ω	82 Ω	68 Ω)
2	28	19	9.5
3	29	20	10.5
4	(+V _b - 0.7)		
5	30	21	11.5
6	28	19	9.5
7	1.25	1.5	1.85
8	(+V _b - 0.65)		
9	0.65	0.65	0.65

All voltages \pm 10%

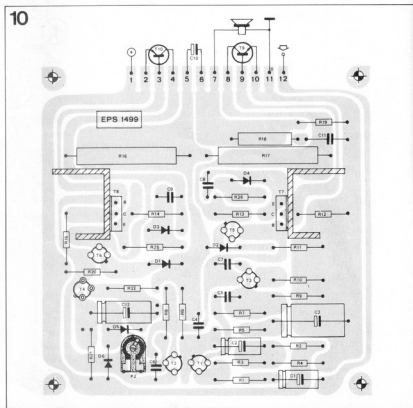
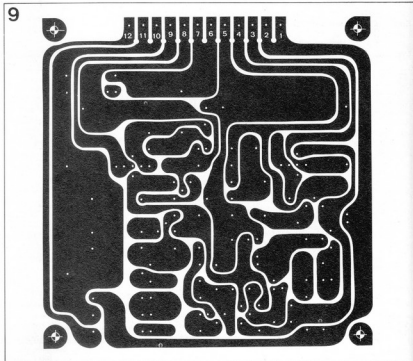

Figure 9. The printed circuit board for the amplifier.

Figure 10. The component layout for the amplifier, when the arrangement of figure 7a is used.

Figure 11. The component layout using the circuit in figure 7b.

recommended. It has been extensively tested with electrostatic loudspeakers and as the driver for the 'electronic' (feed-back) loudspeaker, easily producing more than enough sound level.

The various voltages, currents, loud-speaker impedances etc. can be found from the output power nomogram, else-

where in this issue. As will be obvious, the input sensitivity is equal to the output voltage V_{eff} divided by the amplification. For the 20 watt/8 Ω version for instance, V_{eff} is found to be 12.5 volts. The input sensitivity is therefore approx. $\frac{12.5}{20} = 625$ mV.

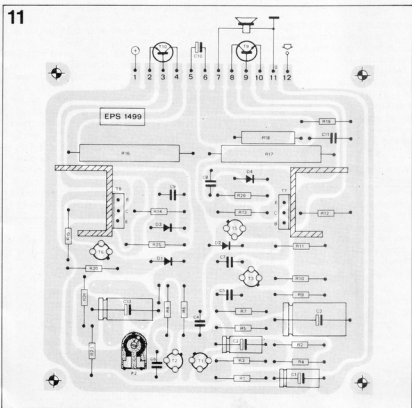
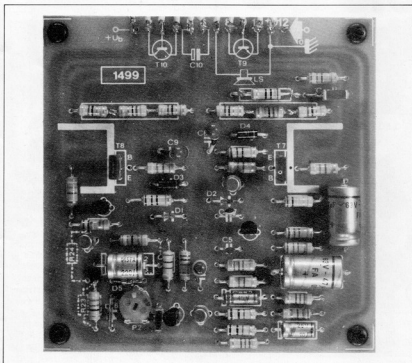

Parts list

Resistors:

- R₁, R₃ = 22 k
 - R₂ = 68 k
 - R₄ = 56 k
 - R₅ = 470 Ω
 - R₆ = 10 k
 - R₇ = 33 k
 - R₈ = 1 k
 - R₉ = 18 k
 - R₁₀ = 180 Ω
 - R₁₁ = 100 k
 - R₁₂, R₁₃, R₁₄, R₁₅ = 470 Ω
 - R₁₆, R₁₇ = 0.15 ... 1.5 Ω
- (see text and table 1)

- R₁₈ = 4.7 Ω
- R₁₉ = 3k3
- R₂₀ = 100 k
- R₂₁ = 68 ... 100 Ω
- R₂₂ = 5k6
- R₂₃ = 1k8
- R₂₄ = 6k8
- R₂₅, R₂₆ = 22 Ω *
- P₁ = 20 k log.
- P₂ = 4k7 lin. (trim.)

* see text and table 2

Capacitors:

- C₁ = 4.7 ... 6.8 μ
(40 ... 70 V)
- C₂ = 2.2 ... 2.5 μ
(2.5 ... 70 V)
- C₃ = 47 μ (40 ... 70 V)
- C₄ = 150 p
- C₅ = 47 p
- C₆ = 10 n
- C₇ = 10 p
- C₈, C₉ = 12 n*
- C₁₀ = 470 ... 2200 μ
(60 ... 80 V)
- C₁₁ = 100 n
- C₁₂ = 220 ... 250 μ
(2.5 ... 16 V)
- C₁₃ = 16 μ (60 ... 80 V)

Semiconductors:

- T₁, T₄, T₅ = BC 177b
- T₂, T₃, T₆ = BC 107
- T₇ = BD 140
- T₈ = BD 139
- T₉ = MJ(E) 3055
- T₁₀ = MJ(E) 2955
- D₁, D₂, D₅, D₆ = DUS
- D₃, D₄ = BA 148*

output power nomogram

This nomogram has been prepared by the editors in response to regular requests from readers. When the required output power and the loudspeaker impedance are known, the nomogram can be used to find the associated voltage and current. It can actually be used as soon as any two of the variables are known—to find the remaining set.

\bar{P} is the continuous (sine wave) power

R_L is the impedance of the loudspeaker

V_{eff} is the effective (RMS) output voltage

\hat{V} is the peak value of the output voltage swing

I_{eff} and \hat{I} are the effective and peak values of the current swing

The power supply must deliver at least $2\hat{V} + 4$ volts (measured to the lowest edge of any ripple waveform). For a stereo amplifier, it must be rated for at least I_{eff} . "Music power"—depending on the power supply and the output stage heat sink—can be anything from 1 to $20 \times \bar{P}$. . . !

Example (see dashed line):

For 20 watts into 8 ohms we find $\hat{V} = 18$ volts and $I_{\text{eff}} = 1.6$ amps. So the power supply must be rated to deliver $2 \times 18 + 4 = 40$ volts at 1.6 amps. **■**

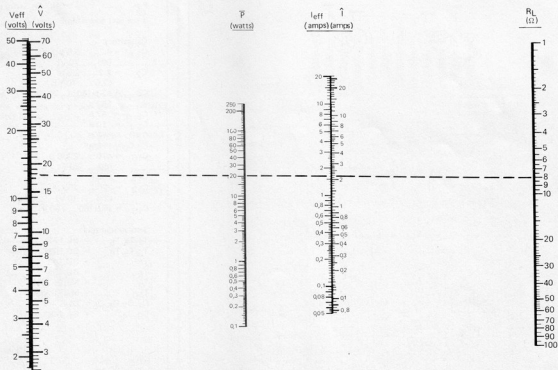
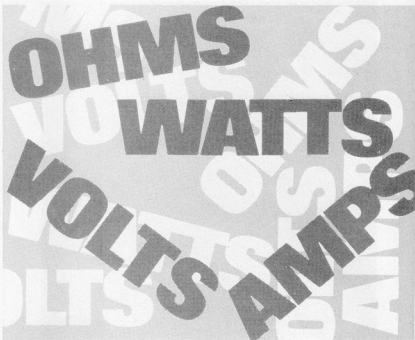

mos clock 5314

The 'brain' in the digital clock described in this article is the clock-IC MM5314, which needs only a few external components. The time of day is indicated by seven-segment Ga-As displays, which are now offered at quite agreeable prices.

Another attractive feature is that if no seconds reading is included in the design, a considerable saving can be made, whilst seconds indication can always be added at a later stage.

The clock-IC

The clock integrated circuit type MM5314 is designed to indicate the time in hours, minutes and seconds with the aid of seven-segment displays. In contrast to the MM5313 it has no BCD output. Consequently, it is smaller (DIL 24 pins), has a simpler construction, and, what is perhaps even more important, is a lot cheaper. However, as appears from the circuit diagram of the MM5314 (figure 1), all the components needed for building a clock are available.

The IC receives its clock pulse from the mains, and can be used for 50 Hz or 60 Hz drive. The supply voltage may vary from 8 V to 17 V and need not be stabilized. If not connected, all drive inputs are at '1' level because resistors are incorporated which connect them to the plus pole of the supply voltage.

As regards the clock design, the IC offers the choice of various possibilities that depend only on a certain logic state of the drive input concerned.

It is possible, for instance, to choose between a 24-hour and a 12-hour cycle. With the 12-hour cycle the leading zero indication is automatically suppressed, which saves a lot of power. If in addition no seconds reading is required, two seven-segment displays and two transistors can be omitted, which gives a considerable saving. By means of the input 'strobe', read-out can be suppressed, and there are, of course, control inputs for retarding or advancing the clock. The clock can also be stopped for correct time setting. The table gives all possible settings of the control inputs. Figure 2a shows a top view of the pins of the MM5314 integrated circuit.

Operation

In the overall circuit of the IC two main sections can be distinguished:

- the counter with corresponding circuits
- the circuits for decoding and driving the displays (surrounded by the dashed line in figure 1).

Pulses to drive the counter are obtained from half cycles of the mains supply. The pulse shaper at the input of the counter changes the sine-waves into square waves by means of a Schmitt trigger. This trigger has a hysteresis of about 5 V. Depending on the logic state at pin 11 of the IC, the pulse signal is divided by 50 or 60, so that a signal of 1 Hz becomes available for the next divider. In the next three stages of the counter the pulse signal is divided into minutes and 12 or 24 hours, depending on the cycle chosen, and determined by the logic state of pin 10.

Via the gates of the individual stages of the counter the clock can be set correctly. If pin 14 of the IC is at '0', the clock will run at the rate of 1 minute per second. If pin 15 is at '0', the hours will run at the rate of 1 hour per second. When pin 13 is at '0', the clock is stopped. If a 12-hour cycle is chosen, the leading zero is suppressed by a special circuit in the IC.

Counter read-out and display drive are achieved with a multiplex technique. The multiplexer senses the various counter positions successively in the rhythm of a multiplex frequency, and passes the value found to a decoder, and from there to an output memory (ROM-Read Only Memory). The multiplex frequency can be varied by means of a simple RC network connected to pin 23.

The multiplex oscillator is followed by a divider that, depending on the logic state of pin 24, produces four- or six-digit drive pulses (with or without seconds, respectively). Using the multiplex technique implies that the displays are not driven in parallel, but in series. Parallel drive means that all counter positions can be read out simultaneously. To that end the counter reading of each decade is, at a certain moment, fed to a memory corresponding to each decade. The information thus stored drives the displays of the counter readings via a decoder. This happens simultaneously for all decades; hence the term parallel drive.

Multiplex technique, however, means that all counter readings are scanned quickly in successive order and are fed in the

same order to an output memory (ROM), which for this IC is programmed for seven-segment displays. At the same time that the counters are read, each corresponding display receives the supply voltage via the drive logic of the block marked 'Digit Enable'. This means that, with this clock, the counters can be read 1 out of 4 if a four-digit display is used, or 1 out of 6 for a six-digit display; the logic state of pin 24 determines the display mode. If, for instance, the one-second counter is read, the one-second display receives supply voltage via 'Digit Enable', and the reading of this decade becomes visible. Corresponding segments of each display are interconnected, but only the particular segments of a display that receive a voltage will light up. In spite of the fact that series drive is used, visual read-out remains constant, provided the multiplex frequency is higher than about 100 Hz. In the MM5314 the multiplex frequency can be chosen up to 60 kHz. If the read-out is suppressed via pin 1 ('strobe') of the IC, the clock will continue to run normally. Thanks to this feature it is quite easy to build an emergency supply.

The circuit

The complete circuit in figure 3 shows that apart from the MM5314 only few components are needed to build a complete clock. Perhaps somewhat unusually, the circuit description starts with the supply, because it is from there that the counter pulses are derived. Since the supply voltage for the IC need not be stabilized, the source has been kept as simple as possible. The d.c. supply voltage may be anything between 8 V and 17 V. The half cycles of the 50 Hz mains are fed to the pulse input via a decoupling network R_{22}/C_3 . This input is protected against overloading by means of diode D_1 .

The RC network (R_{23}/C_4), connected to pin 23 of the IC, determines the multiplex frequency which, for the given values, is about 10 kHz. Because the integrated circuit cannot provide sufficient current to drive the seven-segment

Figure 1. Block diagram of the MM5314 integrated circuit. From this it is clear that the entire clock, except the supply and drive for the displays, is incorporated in this IC.

Figure 2a. The pins of the IC seen from the top.

Figure 2b. Pin details of the Opcoa red GaP seven-segment display type SLA 1. With most other types of seven-segment displays separate anodes are also connected to pins 3 and 9; hence, an extra connection is needed between these pins and pin 14.

Table

function	state *	pin
stop	'0'	13
slow adjustment	'0'	14
quick adjustment	'0'	15
mains frequency 50 Hz	'1'	11
mains frequency 60 Hz	'0'	11
12-hour cycle	'0'	10
24-hour cycle	'1'	10
with seconds	'0'	24
without seconds	'1'	24
strobe	'0'	1

* An unconnected input is at state '1' because within the IC these inputs are connected to the plus of the supply voltage via resistors.

display simple buffer stages are required. These use normal TUN's and are connected between pins 3 to 9 and the display segments. The collector resistors provide current limiting for the segments, so their values determine the luminous intensity of the displays. The minimum permissible value for these resistors is 330Ω ($+V_b = 17 V$); in practice 470Ω gave satisfactory results for all supply voltages. A lower value produced no noticeable increase in luminous intensity, so that in fact only the life of the display is then unnecessarily shortened.

Buffer transistors, acting as switches, are also connected between the 'Digit-Enable' outputs and the anodes of the displays. These switches connect the second-, minute- and hour displays to the

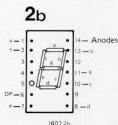
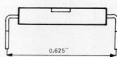
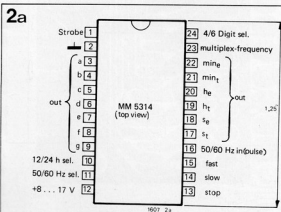
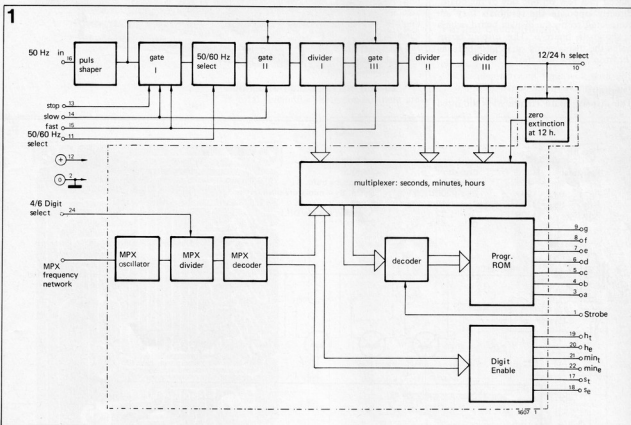

supply voltage at the correct moment. The switching transistors used here are TUPs.

The circuit is mounted on two printed circuit boards: one for the displays, and one for the actual clock circuit with mains supply.

Printed circuit boards

Figure 4 shows the printed circuit board, and figure 5 the component layout for the mains-fed clock circuit. The boards are quite small, so that the whole unit can be housed in a small attractive cabinet. So much space has been reserved on the board for the supply transformer and electrolytic capacitor C_2 that, if necessary, fairly large types can be used. All terminals and controls (50/60 Hz selection, strobe, etc.) are placed in a row on one side of the board, directly opposite the terminals they are connected to on the display board, which is shown in figure 6. This display board holds the displays and small push buttons for 'stop', 'slow' and 'fast'.

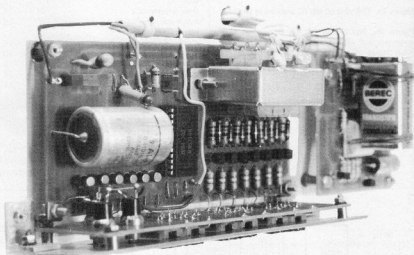

Displays

The display board (figure 6) is mounted

3

Parts list

Resistors:

R1 ... R7 = 10 k
R8 ... R14 = 100 k
R15 ... R21 = 470 Ω
R22, R23 = 100 k

Capacitors:

C1 = 5n6
R2 = 2200 μ /25 V
C3 = 10 n
C4 = 22 n
C5 = 47 n

Various:

Tr = mains trafo, B ... 12V/250 mA
S1 ... S3 = miniature push-button, SPST
IC-socket (24 pin DIL)

Semiconductors:

IC = MM5314
T1 ... T7 = TUN
T8 ... T13 = TUP
D1 = DUS
B = bridge rectifier

B30C500, BY 164 etc.
Displays = Opcoa SLA 1, Monsanto MAN 1, MAN 7 and MAN 10, Texas T 6302, Hewlett Packard 5082 and 7730, Litronix Data Lit

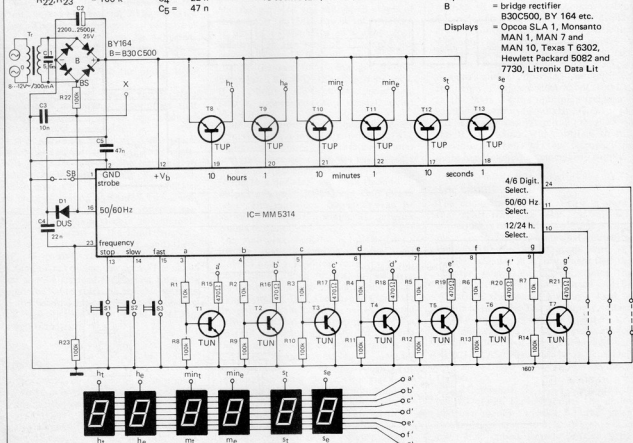

Figure 3. The total circuit complete with mains supply. If instead of TUNs, quality transistors are used for T₁.....T₇ (e.g. BC107), the resistors R₈.....R₁₄ can be omitted

Figure 4. The printed circuit board of the clock circuit with mains supply. The pins are positioned so that only very short connections are needed between clock and display circuit boards.

Figure 5. Component lay-out for the clock circuit. There is sufficient space for almost any type of transformer. Even a 40V electrolytic capacitor could be accommodated on the circuit board.

behind the front plate of the cabinet. Instead of the seven-segment LED displays used here (the Opcoa SLA1), types MAN1, MAN7 and MAN10 of Monsanto, T6302 of Texas, 5082 and 7730 of Hewlett Packard or Data Lit of Litronix can be used. Some of these even have two LEDs per segment, which gives a greater intensity at a slightly lower current consumption. Unfortunately, there are many displays where not all anodes are connected to pin 14, but have separate anodes connected to pins 3 and 9. The pins 3 and 9 (at the bottom of the displays concerned) must then be bent completely inward and connected to pin 14.

With or without seconds

If the 'seconds' indication is not used the expense of two displays, two sockets and two transistors can be saved. In this case there is no connection between pin 24 and earth. Since the board is designed for six displays, two more can always be added at a later time without much trouble.

Connection between the boards

In total (including the seconds) there are

13 control connections between the clock and the display circuit boards. The six pins of Digit Enable (h₁, h₂, m₁, m₂, s₁, s₂) are connected to the corresponding terminals on the display board. Furthermore, the terminals a to g of the clock circuit are connected to the same terminals on the display board. Three other connections run to the three small push-buttons for setting the clock. One side of each button is connected to the supply common.

By means of time signals on the radio, TV, or telephone service, the clock can be started properly and quite accurately. With the buttons "fast" and "slow" the clock is pre-set before the time signal comes, and the button "stop" is released the moment the signal sounds. The front of the cabinet must have openings for the four or six displays which can be mounted behind perspex, for instance.

Further developments

In Elektor laboratories the following additional units have been developed for the clock:

- crystal-controlled time base with only one IC; current consumption complete with oscillator: about 90 μ A.

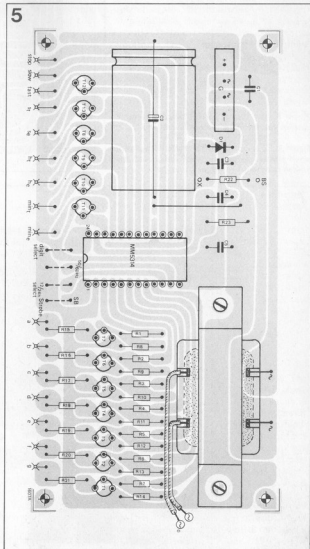
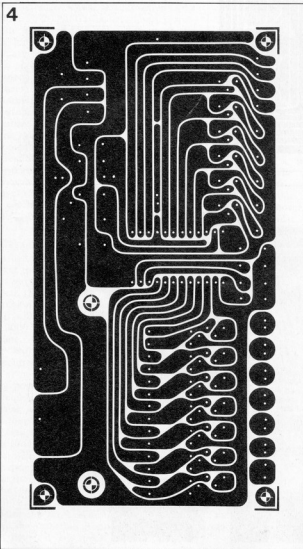

— emergency supply in case the mains supply fails.

These extensions will be discussed in a following issue. The points marked SB, BX and X in figure 3 and in the component lay-out are for use with these units.

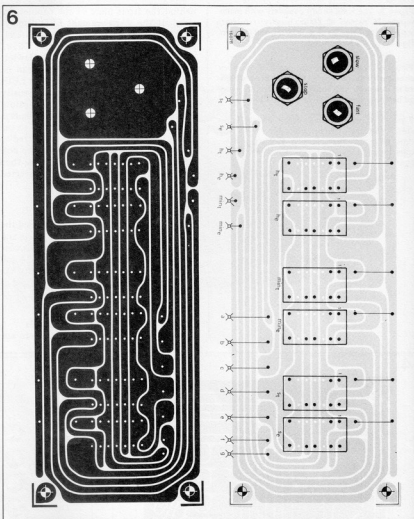
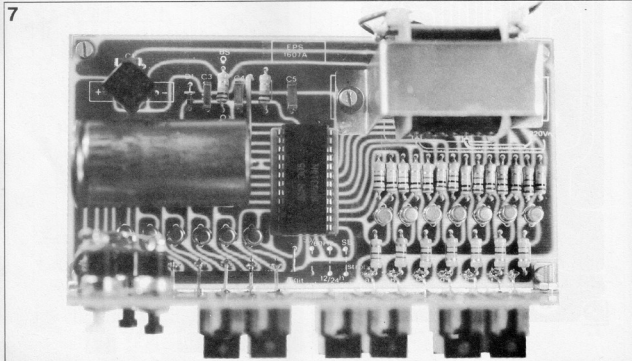

Figure 6. The display circuit board. The small buttons for setting the clock are at the front.

Figure 7. A complete digital clock! The photograph shows the simplicity of design and the limited number of components needed.



distortion meter

The distortion in factory-produced or home-made amplifiers is frequently unknown; designers sometimes give specifications, but these are not always reliable. Since distortion meters are usually expensive,

Elektor Laboratories have developed a simple, inexpensive, but effective instrument.

Low frequency pre- and power-amplifiers always produce some distortion. The various kinds are distinguished as follows: Linear distortion - the departure from a flat amplitude-frequency response curve. An amplifier which is flat within 1 dB from 20-20000 Hz has less linear distortion than another which only does this within the band from 100-8000 Hz.

Intermodulation distortion - when two or more frequencies are fed simultaneously into the amplifier and it produces 'sum and difference' components. Harmonic distortion. This is real 'visible' distortion; if the input was a sine wave the output signal is definitely 'something else'. The output signal can then be shown to consist of the original sine wave (possible amplified), plus several overtones or harmonics. The ratio of the unwanted components to the total output signal gives the distortion percentage. This measurement can be made with the distortion meter described below.

Design considerations

A distortion percentage of 0.01% means that the fundamental in the output signal is virtually ten thousand times greater than the distortion. Therefore, if the distortion is to be measured the fundamental will have to be attenuated more than 10000 times. This is 80 dB! At the same time, the first overtone (second harmonic) must remain unaffected. This requires an exceedingly sharp filter.

For normal low frequency work it must be possible to measure distortion in the frequency range 100 Hz to 10 kHz. The filter will therefore have to be tunable through this band.

Transistorised power amplifiers frequently produce spikes in the waveform at the zero-crossings as well as the normal distortion components. These spikes can be as short as 10 μ s or even less, implying the presence of frequencies in excess of 100 kHz.

After the fundamental has been suppressed the distortion product then appears as in figure 1. The spikes in this trace have an amplitude 1% of the total output! To

enable these spikes to be measured the distortion meter will have to pass the high frequencies involved unattenuated. A passband to 500 kHz is therefore by no means an unnecessary refinement.

For a distortion measurement according to DIN standards, the RMS value of the unwanted products - corresponding to their average power-contribution - is what must be determined. This requires an integrating meter. However, since the human ear responds to the amplitude rather than to the power of a signal, a peak-level detector is what is really needed. This will often show a completely different (much 'worse') result!

An example of this is given in figure 2.

Figure 2a is a trace of the distortion product from a reasonably good power amplifier. The RMS and the peak measurements give the same result - 0.18% distortion.

Figure 2b shows the distortion product from a similar amplifier. Along with 'ordinary' distortion however, this one also produces sharp spikes. The two measurement procedures now lead to totally different results: the RMS meter indicates a distortion increase to 0.21% (0.03% more than before). The peak meter on the other hand now indicates 0.95% distortion - an increase of about 0.75%! The latter value is a more accurate indication of the subjective increase of the distortion. Clearly, a universal instrument will have to be able to carry out both procedures.

Finally, the measurement must be unaffected by hum and noise (which can be identified on the 'scope', but may cause a misleading reading on the pointer instrument). The design will therefore include hum and noise filters which can be switched out of circuit.

The filter

The design chosen for the rejection-filter is an unusual one. When two signals having the same frequency, amplitude and phase are presented to the inputs of a good differential amplifier, the output signal is zero. The signals are blocked.

The block diagram of a rejection filter can therefore be as shown in figure 3.

The input signal is first passed to a phase splitter (paraphase amplifier, with equal-and-opposite outputs). One of these output signals, the one which is 180° out of phase with the input signal, is applied directly to one input of the differential amplifier. The other output of the phase splitter is in phase with the input signal; it is passed to a phase shifter. This section imposes a phase rotation which, depending on the frequency, lies somewhere between 0° and 360°. For one single frequency (f_0) this shift will be precisely 180°. The output of the phase shifter is now applied to the other input of the differential amplifier. For an incoming signal of frequency precisely f_0 which will therefore be rotated exactly 180°, the output of the differential amplifier will disappear - the signal will be rejected. For every other frequency the output signal will be unequal to zero.

The final step is to provide the required sharpness of the characteristic by means of overall negative feedback.

The great advantage of this arrangement is that it does not require trimming, while at the same time it can be tuned over the entire working range using one stereo-potentiometer. The accuracy of tracking of the two halves of this potentiometer is completely unimportant.

Circuit of the filter

The filter circuit is given in figure 4. The transistors T_1 and T_2 form the phase splitter. The in-phase output signal is developed across R_5 , so that the circuit has heavy internal negative voltage feedback like that of an emitter follower (but much heavier in this case). The anti-phase output signal appears over R_4 . This circuit is far better-behaved than any single-transistor arrangement and is used at all important points in this design.

The phase shifter is built up around T_3 to T_6 . It is actually a cascade of two simple phase shifters, each of which imposes a rotation between 0° and 180°. The frequency for which the total rotation

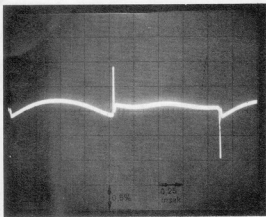

Figure 1. Distortion products from a transistorised power amplifier, viewed after the fundamental has been suppressed.

The fundamental frequency was in this case 1 kHz, the calibration 0.5% per division. The amplitude of the spikes is therefore 1% of that of the fundamental.

Figure 2. Contribution of the spikes to the distortion-percentage according to the DIN standard. Both measurements were done identically:

The X-input is connected to the output of the sine-wave generator (frequency 1 kHz); the Y-input is connected to the output of the distortion measuring circuit. The vertical sensitivity of the oscilloscope is set to correspond with 0.5% distortion per division.

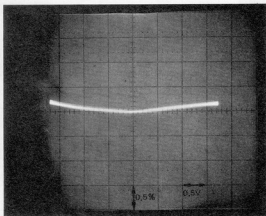

Figure 2a shows a trace without spikes; the distortion according to the DIN standard is 0.18%.

Figure 2b shows a trace that does include spikes; the DIN-measurement yields a distortion percentage of 0.21%.

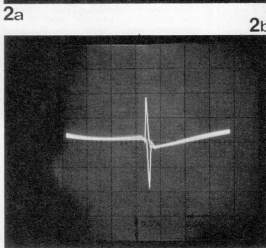

Figure 3. Block diagram of the fundamental suppressing filter used in the distortion meter.

Figure 4. The circuit diagram of the filter. P_1 and S_1 enable calibration of the sensitivity (total signal must read 100%). P_2 and P_3 provide coarse and fine adjustment respectively of the rejection-frequency. P_4 and P_5 provide coarse and fine adjustments of the amplitude balance (maximum rejection). The capacitors C_2 and C_3 must have a high thermal stability.

Figure 5. Circuit of the hum and noise filters and of the $\times 10/\times 100$ amplifier.

amounts to exactly 180° , is f_0 . This frequency is adjusted by means of P_{2a} and P_{2b} . A fine adjustment is provided by P_3 . The capacitors C_2 and C_3 should have low thermal coefficients.

The switches S_{1a} and S_{1b} enable the circuit to be calibrated, in combination with P_1 . When these switches are open the phase shift is 0° for all frequencies; the filter action is defeated and the input sensitivity can therefore be set correctly.

T_9 to T_{13} form the differential amplifier. The impedances in the circuit have been kept low so that it will also behave well at the high frequencies. The inverted (180°) signal from the phase splitter reaches the plus-input via R_{15} and P_5 . The output of the phase shifter is taken from P_4 and applied to the minus-input. These two signals must have precisely equal amplitudes at f_0 in order to cancel. This can be coarsely and finely adjusted using P_4 and P_5 .

The potentiometer P_6 is a preset control for adjusting the DC balance of the differential amplifier, since this depends on the properties of the individual transistors. Set the DC levels at points A and B to be equal (about 4 volts). This is the only trimming point in the whole filter. Overall negative feedback is applied via R_{22} , R_{23} and R_2 .

Hum and noise filters

The circuit of these filters is shown in figure 5. They are active filters, containing RC networks in their input, output and feedback paths. The turnover is fairly sharp and the rolloff slope is more than 12 dB/octave.

The hum filter is built around T_{15} and can be switched into circuit with S_2 . The cut off starts near 250 Hz, the response being more than 20 dB down at 50 Hz.

The noise filter (T_{16}) is switched in by S_3 or S_4 and cuts off at 20 or 200 kHz respectively. Bear in mind that this filter will also suppress any spikes more or less completely. Figure 5 also includes a voltage amplifier (IC_1). This will boost the output signal by 10 or 100, so that a multi-meter can directly indicate distortion at 10% or even 1% fsd. A disadvantage here is that the response of the IC - at a gain of 100 - already starts to roll off at about 20 kHz, so that the output contribution from the waveform spikes is lost.

How to use the meter

Measurements are taken with the equipment arranged as shown in figure 6. The sine-wave generator must have very low distortion. We hope to publish a good cheap design shortly.

The measurement procedure is as follows: Set S_1 to 'calibrate'. Switch all filters and the $\times 10/\times 100$ amplifier out of circuit. Adjust P_1 until the meter reading is 1 V; this is equivalent to a distortion of 100%. Set S_1 to 'measure'. Adjust P_2 and P_4 alternately to obtain a minimum reading. S_5 can be set to ' $\times 10$ ' or ' $\times 100$ ' as may be required for a useful deflection. When the adjustment of P_2 and P_4 becomes too

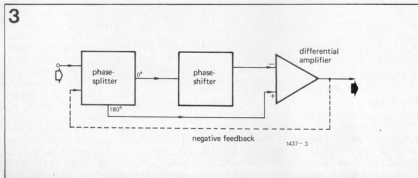

4

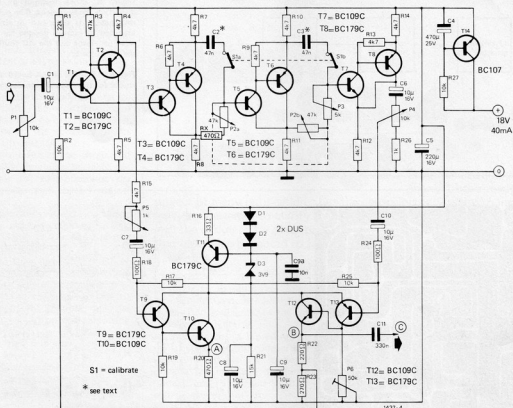

Parts list for the figures 4 and 5.

Capacitors:

C1	= 10 µ/16 V
C2, C3	= 47 n
C4	= 470 µ/2.5 V
C5	= 220 µ/16 V
C6 ... C10	= 10 µ/16 V
C11	= 330 n
C12	= 6n8
C13	= 27 n
C14	= 330 n
C15	= 3n9
C16	= 390
C17	= 18 n
C18	= 1n8
C19	= 47n

C20	= 4n7
C21 ... C24	= 10 µ/16 V
C25	= 10 n

Semiconductors:

T1, T3, T5, T7, T10, T12, T15, T16	= BC 109C
T2, T4, T6, T8, T9, T11, T13	= BC 179C
T14	= BC 107
IC1	= µA 741

Switches:

S1 = 2x break	S4 = 3x make
S2 = 1x changeover	S5 = 2x changeover
S3 = 3x make	S6 = 1x changeover

Resistors:

R1	= 22 k	R31	= 4k7
R2	= 10 k	R32	= 15 k
R3	= 47 k	R33	= 8k2
R4 ... R15	= 4k7	R34	= 5k6
R16	= 33 Ω	R35	= 560 Ω
R17, R19, R25	= 10 k	R36, R37	= 220 Ω
R18, R24	= 100 Ω	R38, R39	= 47 k
R20	= 470 Ω	R40	= 10 k
R21	= 15 k	R41	= 120 k
R22	= 220 Ω	R42	= 1 M
R23	= 270 Ω	P1	= 10 k (lin)
R26	= 1 k	P2	= 2x47k (stereo, log)
R27	= 10 k	P3	= 5 k (lin)
R28	= 68 k	P4	= 10 k (lin)
R29, R30	= 47 k	P5	= 1 k (lin)
		P6	= 50 k (trim, lin)

5

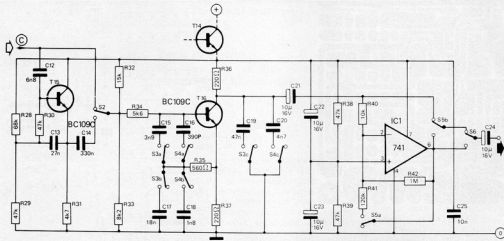

6

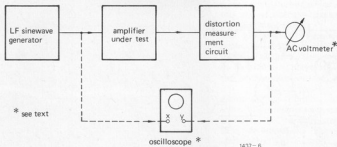
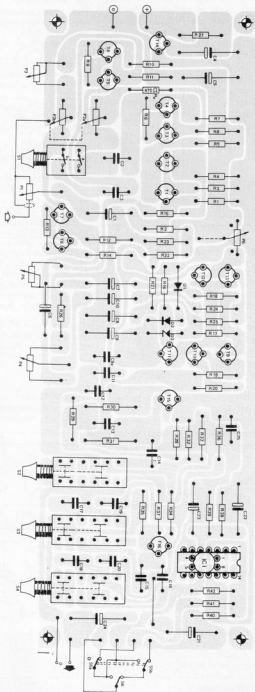
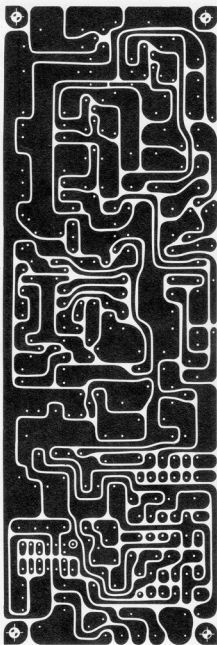

Figure 6. Block diagram of the set-up for distortion measurement. The distortion-measuring circuit is described in this article. It is intended to publish designs for both the sine-wave generator and the AC (milli) voltmeter in the near future.

Figure 7. Printed circuit board and component layout for the distortion measuring circuit.

7



critical, continue fine adjustments with P_3 and P_5 . As soon as the minimum output has been found the distortion can be read directly. Just how this is done will depend on the indicating instrument used. If this instrument is a typical multi-meter, the normal harmonic distortion can be read with reasonable accuracy. The 'x100' position of S_2 then corresponds to an fsd of 1% distortion. The contribution of waveform spikes will be lost, while there is no guarantee of the accuracy of the meter at higher frequencies.

A more accurate result can be obtained if a good AC millivoltmeter is available. Set S_2 in this case to 'x1', otherwise the integrated amplifier with its early rolloff will be in circuit.

Both of these methods have the objection that the indicating instrument integrates, so that its reading corresponds to the RMS value of the distortion.

The amplitude of the distortion products can be measured using an oscilloscope.

Connect this as shown in figure 6. The original signal from the sinewave generator is applied to the X-input and the output from the distortion measuring circuit (at 'x1' gain!) is applied to the Y-input. The trace will now be of the kind shown in figure 2.

Set the 100% level, during calibration, to indicate 3 volts peak-to-peak. 3 mV in the trace now corresponds to 0.1% distortion-amplitude.

It may be possible to improve the readability of the trace by using the hum or noise reduction filters. Remember, however, that the noise filters will also suppress any spikes.

Finally, a very good indicating instrument is an AC millivoltmeter that can be switched to operate as an RMS or as a peak detector. Beware of instruments that use a peak detector but have a scale calibration reading 0.707x the peak value - they only read the RMS level of a pure sinewave. The meters required here use some kind of square-law detector (RMS value of the distortion level).

With such an instrument distortion can be read either according to the DIN standard or as a 'genuine' distortion-percentage.

M

quadro 1-2-3-4... or nothing?

The phenomenon of 'quadrophony'* has already been the subject of many publications, but the confusion only seems to increase with every new attempt to clarify the issue. This article may bring a little light into the darkness, by describing and comparing the most important systems that have been proposed so far.

In order to simplify the comparison of the various systems, we shall proceed from a block diagram of the total sound signal path (figure 1).

In this diagram, A represents the recording location (studio, concert hall, etc.) in which a number of microphones are placed. The type and number of microphones used and their position are, of course, significant for the maximum quality of transmission that is attainable. Many fundamental investigations dealing with these aspects are going on at the present time, but they will not be dealt with in this article.

Block B represents the total chain of electronic devices that perform the coding, transmission (via gramophone record, tape or radio) and decoding. One of the possible quadrophonic systems is introduced into this chain.

Block C forms the end of the chain as the living room in which the loudspeakers are usually placed in the four corners. The various systems in block B can now be compared to each other by relating the sound impression reproduced in space C to the original sound impression that was derived (by the recording technician) from the sound event.

First of all, the basic methods of operation of the various systems will be briefly discussed.

Types of system

In general, we can draw a distinction between three different types of system:

* Four channel stereo, an accurate but somewhat clumsy phrase, is variously referred to as quadrophony, quadraphony, quadronics, quadronics, quadrasonics, tetraphony, surround sound, et al. In this article 'quadrophony' is used for the sole reason that it can be abbreviated to 'quadro', which goes with 'mono' and 'stereo'.

After all, 'that which we call quadro by any other name would sound the same'

quasi-quadrophony (or pseudo-quadrophony, similar to pseudo-stereophony), 'discrete' quadrophony with four independent transmission channels and, finally, quadrophony according to matrix systems.

Quasi-quadrophony is based on the experience that a 'spatial impression' enhances the reproduction - regardless of whether or not the reproduced sound actually corresponds to the original as far as the positioning of the various instruments or groups is concerned. Such systems can, for example, reproduce reverberation (or the difference signal from two stereo channels, which usually contains a lot of reverberation) via the two rear loudspeakers. This is sometimes referred to as a '2-2-4' system, in other words a system that uses 2 original sound channels, 2 transmission channels and 4 reproduction channels. It goes under various banners, such as 'Stereo-4', 'Quadro-sound' etc. However, it is not quadrophony in the true sense and will therefore not be discussed any further in this article.

A discrete quadrophonic system contains four different channels that remain separated within section B of figure 1 - from the microphone to the loudspeaker (a '4-4-4' system). An example of this is the CD-4 gramophone record-CD stands for Compatible Discreteness. An experimental radio transmission that used two stereo FM transmitters for one program could also be included in this group. Finally, matrix systems are based on the mixing of the original information channels. What were previously four channels of the total quadrophonic recording are now combined into two new, specially-coded channels. They can then be conducted over normal stereo systems, divided again into four channels at the destination and reproduced by the four loudspeakers in the listening room. These systems are classed as '4-2-4'.

Since only two equations cannot be solved if they contain four unknowns, the four resulting channels will in the last analysis never be identical with the original four: they must always contain

cross-talk components. According to the choice of the mixing relationship, however, the spatial sound impression during reproduction can correspond more or less satisfactorily to the original.

CD-4

This system, advocated by Nivico and RCA, is a discrete system.

On a gramophone record, the left 'stereo' channel now contains the sum signal of 'left front plus left rear', and, in addition, a frequency modulated 30 kHz carrier with the difference signal 'left front minus left rear'. The right 'stereo' channel carries the two signals 'right front plus right rear' and 'right front minus right rear' in the same way. For reproduction, the four original channels can (in principle) be regained by simple addition and subtraction of the respective sum and difference channels.

The modulation of the left channel is shown schematically in figure 2. The sum signal with a bandwidth of 15 kHz is cut in the usual way. The difference signal is frequency modulated on a 30 kHz carrier. This modulation is asymmetrical (-10 kHz, +15 kHz), which easily gives rise to amplitude modulation and distortion.

The practical results with this system are discussed in the comparative section.

SQ and QS

SQ (by CBS and Sony) as well as QS (by Sansui) are matrix systems - the abbreviations stand for 'Stereophonic Quadrophonic' and 'Quadrophonic Stereo', respectively. Here the four original channels are mixed into two for transmission and are divided again into four before reproduction.

In the case of SQ the mixing relationship (in amplitude and phase) is set up for optimal channel separation between left and right front, respectively, and between left rear and right rear. The front channels

are cut in the same way as normal stereo channels. CBS chose this system because it was expected to produce optimal effects in the case of possible traditional stereo reproduction. From the comparative section, it can be seen to what degree this was achieved. The unavoidable cross-talk takes place between 'front' and 'rear', audibly along both diagonals. In the case of QS, on the other hand, a mixing relationship that should make acceptable quadrophonic reproduction possible was chosen. A point-like sound source in the recording area is reproduced with an amplitude characteristic that is very close to cardioid. The sketch in figure 3 shows this characteristic for BMX, which will be discussed in the next section. For both QS and BMX this characteristic is always oriented towards the position of the original sound source. The Japanese 'regular matrix' standard (RM) is based on the QS system.

UMX

UMX is a 'universal matrix system' derived by Professor Cooper (USA) in collaboration with Dr. T. Shiga (Japan).

The practical development followed in cooperation with Nippon Columbia (trade name: Denon). This firm is a member of the Hitachi group.

The point of departure was a thorough scientific investigation of the characteristics of matrix systems. From this the optimal two-channel matrix was derived: BMX. By the addition of a further channel, the three-channel TMX was produced, while QMX works with an extra fourth channel. Of relevance here is the fact that the position of the phantom sound source during reproduction is not altered during transference from two, via three to four channel transmission. The localization does become more precise: with BMX, a solo instrument sounds somewhat 'mushy' (spread over a distance of about 0.5 meters), but with the higher order systems TMX and QMX the sound

seems to come from a precisely determinable point.

The characteristics of amplitude and phase, as they arise during the reproduction of a single point source, are shown in figure 3. The amplitude characteristic of BMX is the same as for QS, and is always oriented towards the original position of the sound source. An essential difference from QS lies, however, in the fact that with BMX the phase characteristic also 'rotates': 0° corresponds to the direction of the sound source, while, for example, the sound coming at right angles to the sound source is phased at $\pm 45^\circ$. This additional information gives a significantly better localization. With the QS-system, 0° phase rotation always corresponds to the sound from the phantom centre front, so that sound sources in the front are drawn towards this point.

In the case of gramophone records in UMX (called UD-4) the two basic channels of BMX are recorded in the same way as for stereo. One basic channel contains the mono signal (sum signal), while the other contains the difference information for the stereo or quadro effect. The third (TMX) and fourth (QMX) channels are frequency modulated on two 30 kHz carriers, similar to those used for CD-4. An essential difference from that system, however, lies in the fact that these two auxiliary channels can be contained in a fairly narrow band. An audio bandwidth of 3 kHz is completely satisfactory, and this can be transmitted as symmetrical frequency modulation with a peak deviation of ± 6 kHz (figure 4).

This limiting of the audio band is possible, because there is hardly any audible difference between BMX and QMX at frequencies above about 3 kHz!

Since the orientation of the various sound sources is the same for all three systems, the transition from QMX to BMX at this cutoff frequency is almost imperceptible.

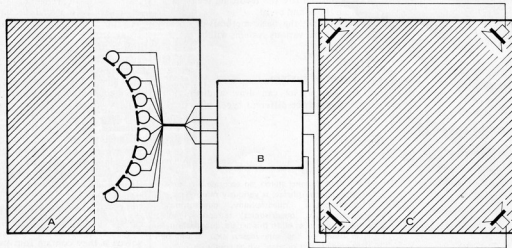

TMX is mainly of interest for radio broadcasting: a third channel can be rather simply provided (for example, by quadrature modulation); however, four channels appear to be an impracticable process - at least in Europe. Greater bandwidths would be required for the transmission of four channels, and these would lead to unacceptable interference on neighbouring channels.

Conclusions

From the comparison of the four systems it is apparent that SQ seems to be based on a different conception of quadrophony: to arrive with 'logic' at four

stressed 'corners' (and also 'centre front'). This is successful to the extent that presentations can be very impressive in spite of the noted shortcomings.

The results of CD-4 and QS are adequate. Since several parameters are not optimal, the peripheral devices for noise reduction and image position stabilization are unnecessarily complicated. In spite of these additional devices, however, the results are not completely satisfactory.

Finally, the UMX system combines the best features of both systems to give the best results. Therefore, from a technical viewpoint, this system is to be preferred. Unfortunately, the discussion of quadrophony is at present clouded by confusion

of language and by commercial considerations. Partly because of this, the UMX system has often been practically ignored.

It is often argued that UMX was developed too late, so that great investments already lie in other systems. Professor Cooper argues strongly against this. In his opinion, the differences from the other systems (especially CD-4) are so slight that possible changeover offers no difficulty.

The number of gramophone records already pressed according to a certain system should not (yet) be decisive either. It would be another matter if a company began to use a particular system for its entire record collection. Fortunately, this has not yet happened.

In view of the rapidly increasing demand for quadrophony especially in the USA and Japan but also in Europe, there is still hope that a definitive choice will be made in the near future. In this event, it is to be hoped that technical arguments will be decisive, and from the technician's standpoint this article could have been entitled: UMX ... or nothing!

References:

- Y. Makita, 'On the Directional Localization of Sound in the Stereophonic Sound Field', *EBU rev.*, pt. A, no. 73, p. 102 (June 1962).
- R. Itoh, 'Proposed Universal Encoding Standards for Compatible Four-Channel Mixing', *Journal of the Audio Engineering Society (JAES)*, April 1972, p. 167.
- D.H. Cooper and T. Shiga, 'Discrete-Matrix Multichannel Stereo', *JAES*, June 1972, p. 346 and July 1972, p. 493.
- P.B. Fellgett, 'Directional Information in Reproduced Sound', *Wireless World*, Sept. 1972, p. 413.
- P.B. Fellgett, 'The Japanese Regular Matrix', *Hi-Fi-News*, Dec. 1972, p. 2393.
- B.B. Bauer, G.A. Budelman and D.W. Gravenaux, 'SQ Matrix Quadraphonic Discs', *JAES*, Jan. 1973, p. 19.

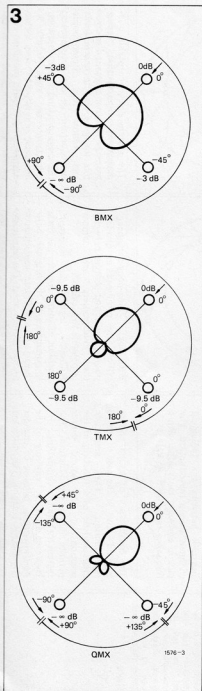
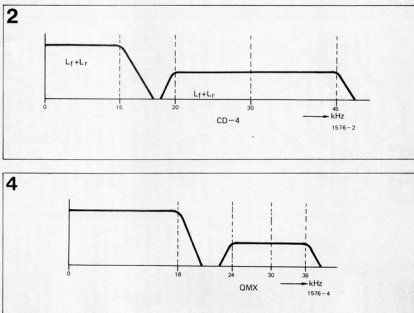

Figure 1. Block diagram of a complete quadrophonic sound chain. A = recording area; B = transmission system, C = reproduction area.

Figure 2. Frequency spectrum on one record groove wall when recording according to the CD-4 system. The sum signal is recorded in the normal way in the base band (0...15 kHz). A 30 kHz carrier is frequency modulated with the difference signal in the band from 20 to 45 kHz.

Figure 3. Amplitude and phase characteristics of the systems BMX, TMX and QMX. 0 dB of the amplitude characteristic and 0° of the phase characteristic always coincide with the position of the sound source. If several sound sources are reproduced simultaneously, one can imagine the appropriate characteristics as "piled on top of one another".

Figure 4. Frequency spectrum when recording according to the QMX system (one groove wall). The two BMX channels are recorded in the base band (0...18 kHz). The two auxiliary channels are each modulated on a 30 kHz carrier (FM), in the band from 24 to 36 kHz.



CD-4

System: 4 discrete channels, of which two are cut in the usual way; the two extra channels are frequency modulated on a 30 kHz carrier. The analogous Dorrén system for FM radio is unsuitable for Europe.

Disadvantages:

Wavering amplitude relationships between the channels lead to crosstalk and constant changes in localization. The asymmetrical frequency modulation can lead to AM by-products and distortion. The wide information band in the FM auxiliary channels leads to noise problems, so that a noise reduction device is indispensable. For this the ANRS system was developed, which has many similarities to the Dolby system; however, this does not appear to function properly in practice if the carrier level changes (for example, due to record wear), probably because the FM detector is not optimal. Moreover, distortions of the auxiliary channels occur which take the form of distorted crosstalk between the individual channels during reproduction. The pickup cartridge must cope with a frequency range up to 45 kHz.

Results:

The localization of sound source is good - also in the case of stereo reproduction. The amplitude characteristic as a function of the position of the sound source permits mono reproduction. The system is therefore compatible. However, a distinct 'waving' of the position arises, because of changes in channel balance. The distorted crosstalk results, for example, in a

SQ

Matrix process that in recording produces two pairs of completely separated channels, one for left front/right front, and one for left rear/right rear, respectively. Only intensity stereophony is possible.

Strong crosstalk between both pairs of channels is unavoidable. 'Delay time' or 'phase stereophony' is not possible, because this leads to localization errors. With an automatic gain control ('gain control logic') it is possible to distinctly localize a signal that comes from one of the four corners or from centre front. However, this can only be done for one sound source at a time, namely the strongest, and it influences the position and loudness of the signals from all other sound sources. Without this gain control, everything is drawn by crosstalk to 'right front' or 'left rear'.

With 'logic': 'Ping-pong-pang-peng' effects are produced in quadrophony, but sound sources between the loudspeakers are almost impossible to localize. Without 'logic' the apparent position of sound sources has little in common with the original - both during quadrophonic and stereophonic reproduction. The amplitude characteristic as a function of the

QS

Matrix that provides a 'cardioid' amplitude characteristic during reproduction (oriented towards the sound source). The phase characteristic is fixed: 'zero degrees' is always centre front, 180° is centre rear.

Because the phase characteristic is fixed, localization suffers: the apparent position of a sound source is drawn towards centre front or centre rear. With an automatic phase-directed volume and phase control 'variomatrix' the position of the strongest sound source can be accurately localized, regardless of its position.

The system gives acceptable quadrophonic reproduction, apart from the fact that the sound sources pile up somewhat in centre front and centre rear. Stereophonic reproduction is also satisfactory; the original sound image (between left front and right front) is, however, reproduced "on a rather narrow stage". Both problems can, of course, be remedied by mod-

UMX/UD-4

Matrix, consisting of two (BMX), three (TMX) or four (QMX) channels. Theoretically, the number of channels could be increased at will. With an increasing number of channels the amplitude characteristic becomes more and more sharply oriented towards the sound source. The phase characteristic rotates in all systems; the 0° point always coincides with the position of the sound source.

Apparently none.

Particularly good for quadrophonic, stereophonic and monophonic reproduction. QMX is the obvious choice for gramophone records, while TMX is important for FM radio. A great advantage lies in the fact that cheaper equipment need only detect and decode the two basic channels (as with stereo or QS) to produce good quadrophony (BMX). More expensive equipment,

on the other hand, can also detect the third and fourth channel to attain a reproduction with more precise localization. Any crosstalk between the channels causes less precision in the localization of positions, but it does not cause position displacement.

oving the recording technique. Mono reproduction is thoroughly acceptable. The only flaw is the fact that sound sources from centre rear are reproduced very weakly or not at all. As long as this is only reverbation, the effect is less noticeable. With certain recordings, however, instruments or other important sounds can be suppressed.

position of the sound sources leads to such a remarkable level pattern that even mono reproduction is unsatisfactory.

trumpet blast from one corner being accompanied by distorted sounds from the other corners.

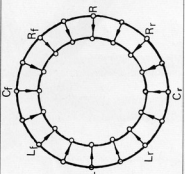
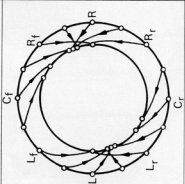
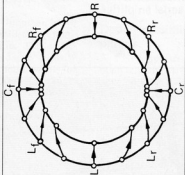
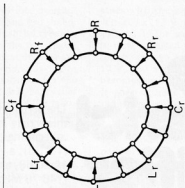

Figure 5. Comparative view of localization during quadrophonic reproduction according to the four systems. The outer circle shows the position of the sound source in the original, while the inner circle shows the position localized during reproduction (derived from the theory of Makita).

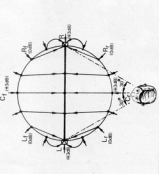
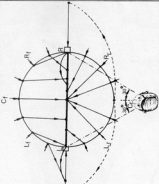
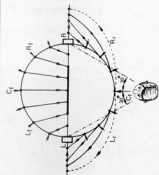
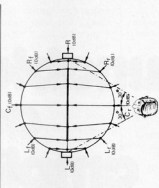

Figure 6. Comparative view of localization in traditional stereo reproduction. The circle shows the original position of the sound source, while the apparent position during reproduction is indicated on the horizontal line (Makita). The loudspeakers are at points L and R.

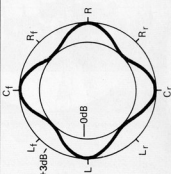
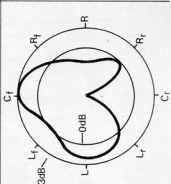
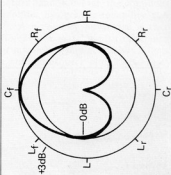
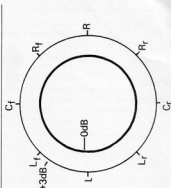
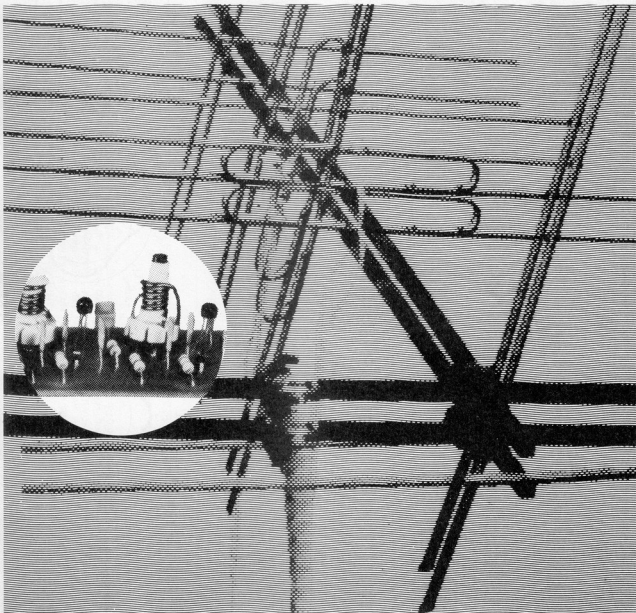

Figure 7. The amplitude characteristics in mono reproduction as a function of the original position of a sound source.

tunable aerial amplifier

The aerial amplifier described in this article is characterized, among other things, by its low noise level (1-2 dB), a voltage gain of 10-20 dB, and a wide tuning range (146-76 MHz).

It is designed for use as an FM-aerial amplifier, although it is relatively simple to modify it for application as a TV aerial amplifier.



Aerial amplifiers can be divided roughly into two categories: wideband and tuned. The main advantage of wideband types is, of course, to be found in the fact that a frequency spectrum of several decades can be amplified without anything having to be switched over or readjusted. On the other hand, there are some drawbacks that count all the more if the amplifier is expected to provide maximum improvement in reception quality.

Using wideband amplification entails the following drawbacks:

1. Cross modulation soon occurs because the total amplitude offered can be fairly large. Furthermore, the entire amplified spectrum is fed to the receiver and this is another likely cause of cross modulation.
2. In most cases it is impossible to design a wideband amplifier for minimum noise contribution. This is because the cable impedance (usually 60 Ω) is not the optimum value for the amplifier. In addition, it is almost impossible to compensate fully for parasitic capacitances.

Comparison of the noise contributions of TV tuners and of wideband amplifiers shows that both are usually of the same order of magnitude for the UHF band. In the VHF-TV and the FM bands, the tuner often has an even lower noise figure than the wideband amplifier. If the wideband amplifier gives better reception, this is due mainly to the fact that when the amplifier is placed between the aerial and the cable, the cable losses become far less important.

Tunable amplifier

A drawback of a tunable amplifier is that an extra cable is usually needed for the tuning voltage. By means of a simple circuit, however, (figure 1) it is possible to use a tunable amplifier without an extra cable. The stabilized power supply provides the sum of the supply voltage and the tuning voltage, and within the amplifier the 12 V supply is obtained by stabilization with a voltage regulator diode. By connecting a 12 V regulator diode in

series with the supply voltage, the tuning voltage is 12 V lower than the supply voltage. If the variable stabilized supply is now adjusted from 14 to 26 V, the supply voltage for the amplifier remains 12 V, and a tuning voltage of 2 to 14 V becomes available.

It goes without saying that the variable supply must have a very low hum and noise level to avoid amplitude and phase modulation via the varicaps. Therefore a large electrolytic capacitor is placed in parallel with D_2 .

The circuit consumes about 100 mA, but offers the advantage that the amplifier always is at a higher temperature than ambient, so that water condensation and the resulting corrosion are avoided.

Design possibilities for tunable amplifiers

A FET-amplifier can be based on two main circuits, to wit: the common-gate and the common-source amplifiers. Since the amplifier is tuned, the input and output capacitances of the semiconductors usually present no problems. Not so, however, the feedback capacitance, because this may give rise to instability. Another important quantity is the input impedance. If we tabulate the necessary design data, we get something like table 1.

	common source	common gate
input impedance	specified by the manufacturer; can be anything between 1 and 20 k Ω at 100 MHz	usually deviates no more than 20% from 1/S
output impedance	specified by the manufacturer and is usually of the same order as the input impedance at common source	
feedback capacitance	1-10 p	very low; usually 0.1-0.01 p

The drawback of the common-gate amplifier is that its maximum gain is less than that of the common-source circuit. On the other hand, however, the common-gate amplifier has greater reliability and stability. A secondary advantage is that the difference in matching for minimum noise or maximum gain is much less than for the common-source circuit, and is in some cases even negligible. Radio reception requires matching to minimum noise, TV reception requires matching to maximum power gain to eliminate cable reflection (picture "ghosts").

The circuit (figure 2)

To obtain a wide matching range, the circuit is designed around discrete coils. This also offers greater freedom as regards using other types of FET. Often mistakes are made as regards the quality factor of such home-made coils; in this case a Q-factor of 100 or more can easily be achieved.

Although the diagram shows the amplifier with asymmetrical input and output, it can easily be adapted for application with symmetrical aerials by providing L_1 and L_3 with coupling windings. To eliminate the problem of the (wide) tolerance in the pinch-off voltage, the gates are connected to a positive voltage so that each of the FETs draws about 10 mA. For a 12 V supply voltage, the gate-drain voltage is about 6 V, and for most types

Figure 1. With simple means the coax cable can be used for the signal-, the supply- and the tuning voltages.

1

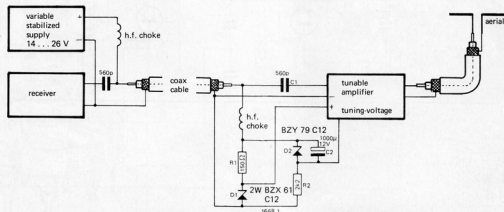

of FET this produces the minimum noise contribution. The only limitation to using certain FETs is the slope, which should be greater than 4 mA/V. A large number of types meet this requirement, as shown in table 2.

type	minimum slope mA/V	dB noise contribution (typ) at 100 MHz
E300	4,5	1,5
E310	10	1,5
U1994E	4,5	1,5
2N4416	4	1,2
2N5397	6	1,8
U310	10	1,5
E304	4,5	1,7
SD201 (mos)	13	1,5

The fact that the circuits possess a high-Q-factor does not necessarily imply that the amplifier is a narrow-band type. The circuits are damped by the input and output impedances of the FETs. Suppose the no-load Q-factor is 100. The resonance impedance then found at 100 MHz is:

$$Z = Q\omega L = 15 \text{ k}.$$

The efficiency of a circuit is given by:

$$\eta = \frac{Q_0 - Q_L}{Q_0}$$

where Q_0 and Q_L represent the quality factor under no-load and load conditions, respectively.

So for a high efficiency it is necessary to load the circuit heavily, which also reduces the effect of the FET output impedance. For the case where $Q_0 = \infty$, and the output impedance of the FETs is ∞ , the gain is given by (figure 3):

$$\begin{aligned} A_v &= n_2/n_1 \cdot S_1 \cdot (n_3/n_4)^2 \cdot n_4/n_3 \cdot S_2 \cdot (n_5/n_6)^2 \cdot n_6/n_5 \cdot Z_C = \\ &= \frac{n_2 \cdot n_3 \cdot n_5}{n_1 \cdot n_4 \cdot n_6} \cdot S_1 \cdot Z_C \end{aligned} \quad (1)$$

If we take

$$\begin{aligned} Z_C &= 50 \quad n_2/n_1 = 1.2 \\ n_3/n_4 &= 2.5 \quad n_5/n_6 = 5 \end{aligned}$$

(1) becomes:

$$A_v = 750 S_1 \quad (2)$$

From the above formulae it appears that the gain is directly proportional to the slope of the first stage. This is only true, if the ideal condition ($Q_0 = \infty$ and infinitely high output impedances) is sufficiently approached, and that is the case here if S_2 is at least 4 mA/V.

It is logical, therefore, to use for T_2 a cheap FET that meets this requirement, such as the U 1994 E or the E 300. Measurements where $T_1 = T_2 = E 300$ indeed showed a voltage gain of 3. When a type E 310 was used for T_1 ($S = 10 \text{ mA/V}$), the gain increased to about 8.

To investigate the effect of T_2 on the gain, first a type E 310 was used, with the result that the gain increased to 10. Since the primary function of an aerial amplifier is to improve the signal-to-noise ratio at the amplifier input, it is pointless to measure the bandwidth at the 3 dB points. It is better to quote the bandwidth in which the noise contribution may deteriorate a certain amount, say 0.5 or 1 dB. If this standard is used, the bandwidth of the amplifier is about 3 MHz at 100 MHz, but this could not be measured exactly because the ektor laboratories are not equipped with the (extremely) expensive equipment needed to take accurate noise measurements.

The ratio n_2/n_1 given in the example above, and which is lower than might be expected, was determined empirically for a minimum noise contribution, and this adaption proved to be the most favourable one for both the E 300 and E 310. If the coils are made of silver-plated copper wire, it is quite a simple matter to determine the best tap.

Figure 2. Although the supply voltage in the diagram is 13 V, the amplifier can be connected to any supply voltage between 10 and 20 V. At about 13 V the noise contribution is lowest.

Figure 3. This simplified diagram serves for a rough calculation of the gain.

Figure 4. The drawing shows how the coils should be wound.

Figure 5. The method for coil mounting shown here saves considerable time. Overall performance does not suffer, but the appearance is not so neat.

2

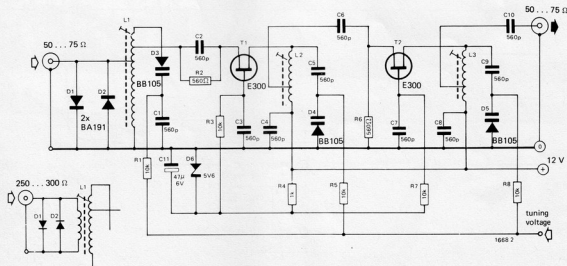

Mounting, construction and adjustment

An important requirement is that all connections must be as short as possible. Photograph 1 gives a clear picture of the mounting. The FETs should have much shorter connecting leads than shown in the photograph (about 6 mm); long leads have distinctly unfavourable effects on stability and the signal-to-noise ratio; this was being verified when this photograph was taken.

All capacitors, except for C_{11} , are of the low-loss ceramic disc type. Current types of Schottky diodes can be used for D_1 and D_2 , and types BB105A, BB105B and BB105G are suitable for D_3 to D_5 . The coils are wound on Kaschke coil formers type KH 5/22, 7-560-8A, with a ferrite core, type K 3/12/100. Several other types of coil formers might be suitable as well, if the diameter is about 1/4 in. (6 mm) The ferrite core has to be a VHF-type! The winding data are given in table 3.

Table 3.

coil	tap with respect to + or - V_b	total number of turns
L_1	aerial 50/75 Ω 2 240/300 Ω 4 (coupling winding)	5
L_2	source 2	5
L_3	output 50/75 Ω 1 240/300 Ω 2 (coupling coil)	5

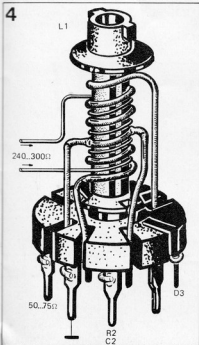
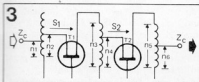

The wire should preferably be silver-plated copper wire with a diameter of 1.2 mm. The spacing between the turns is 0.8 mm and is obtained simply by winding a so-called "blind wire" of a diameter equal to the spacing, i.e. 0.8 mm, together with the coil wire. Once the coil has been mounted, this blind wire is, of course, removed unless the 240/300 Ω connections are to be used. In that case the blind wire is 0.8 mm enamelled copper wire, and after mounting of the coil, this blind wire is wound off again until the above number of turns is left.

As the coupling coils must be placed at the 'cold end', winding back takes place

from the coil end that is connected to the varicap. This is illustrated in figure 4. Soldering the wires to the former pins is a time consuming job, particularly for the wire diameter quoted here. If more value is set upon efficient mounting than on appearances, the coils are mounted directly in the circuit, as shown in figure 5. The coil formers will fit only after clipping, as can be seen in this figure. In this case the coils are wound on a drill with a slightly smaller diameter (about 0.1 mm) than the outer diameter of the coil former.

If the receiver used is not tuned by means of varicap diodes, the aerial amplifier should be adjusted as follows. Set the

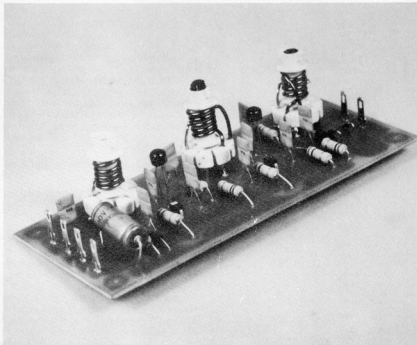
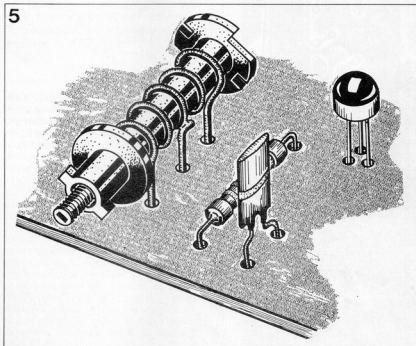

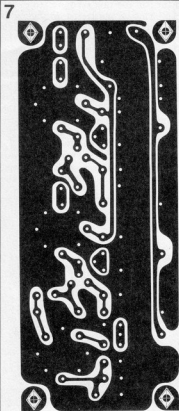
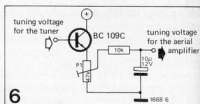
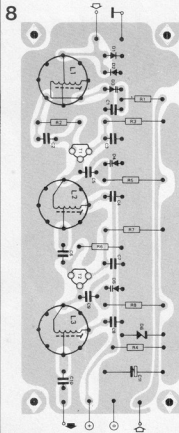

Figure 6. To obtain the tuning voltage for the amplifier from a tuner with a high-impedance tuning voltage, such as tap presets for instance, an emitter follower is required. If a low-impedance tuner voltage is used, the tuning voltage for the amplifier can be obtained directly via the 47 k adjustment potentiometer.

Figure 7. Layout of the printed circuit board.

Figure 8. Component layout on the PC board in figure 7.



Parts list

resistors:

$R_1, R_3, R_5, R_7, R_8 = 10 \text{ k}\Omega$
 $R_2, R_6 = 560 \Omega$
 $R_4 = 1 \text{ k}\Omega$

capacitors:

$C_1 \dots C_{10} = 560 \text{ pF}$ ceramic disc.
 $C_{11} = 47 \mu\text{F}, 6 \text{ V}$

semiconductors:

$D_6 = 5\text{V}6$ regulator diode

other semiconductors: see text!

ferrite cores half way in the formers. Tune the receiver to a weak station with a frequency of about 95 MHz and adjust the tuning voltage — the voltage applied to the varicap diodes — to obtain a maximum output. Tune L_2 and L_3 to increase the output still further or to obtain a maximum; adjust L_1 to reduce the noise of the received signal to a minimum. If the varicap diodes are three matched diodes, the aerial amplifier will now track correctly over the range 76 to 146 MHz.

If the receiver is tuned by means of varicap diodes, the voltage that controls them can also be used to control the diodes in the aerial amplifier. However, to prevent overloading the receiver, the voltage should be applied to the diodes in the aerial amplifier through an emitter follower as shown in figure 6. The tuning procedure now is as described above, except that a weak station with a frequency of about 88 MHz should be used and P_1 is set to give a maximum tuning voltage. Next turn the receiver to a weak station at 100 MHz, and again adjust P_1 to obtain a maximum output. Tune the receiver to 88 MHz and readjust the three cores to obtain a maximum output (L_2, L_3) with the least noise (L_1). Tune the receiver back to 100 MHz and check that no further adjustment is required; the aerial amplifier should now track correctly over the band 76 to 146 MHz. If further adjustment is needed, then repeat the whole procedure until it is not.

Results and application in the 2 m amateur band

The sensitivity of F.M. tuners can be limited by:

1. the signal-to-noise ratio at the input, and
2. insufficient amplification of the intermediate frequency.

Most factory-made receivers are designed so that a combination of these two factors is operative. Although it is difficult to give an exact rule for the improvement obtained by using the amplifier, it may be expected that the sensitivity of the receiver will improve by about a factor of 3 for the same signal-to-noise ratio. If still great-

er amplification is required, the amplifiers can be cascaded. An amplification factor of more than 10, however, will usually give rise to cross modulation in the receiver; the same amplification can also be obtained by means of one amplifier equipped with FETs that have a steep slope. The coils described can be used in the two-meter band, but the varicaps must then be replaced by ceramic trimmers of 1-9 pF. The bandwidth is more than sufficient to cover the entire band.

Conclusions

The aerial amplifier discussed in this article is suitable for many applications and has such a low noise figure that it will improve reception in all cases. Apart from the 76-146 MHz range, the amplifier, with modified coils, can also be used to great advantage in the following bands:

14,21 and 28 MHz amateur band, channel 2-4 TV, channel 5-12 TV, and perhaps the U.H.F. band. These further applications may be discussed in one of the next issues of *Elektor*.

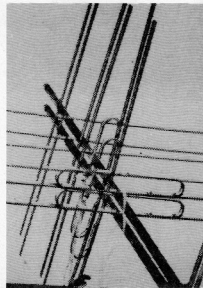

tap sensor

An important alternative to the mechanical switch — rotating or push-button — is the touch switch. This has the advantages of greater reliability and a higher switching speed, as well as being noise-

less and not subject to wear. Furthermore, front panels with touch contacts can be made available as printed circuits, so that it becomes much easier to build equipment with a neat appearance.

Elektor laboratories have been asked to design a touch control switch with a single touching point and costing no more than its mechanical equivalent. Consequently, our laboratories have produced the Touch Activated Programmer or TAP.

Basic possibilities

Operating a switch — touching, turning or pushing — is in effect feeding in a signal that must be stored somehow. The mechanical switches do this by remaining locked in their new positions; a touch switch, however, cannot store a signal

unless it is provided with a memory.

If a switch is to be operated by touch, its input resistance must exceed the resistance of the finger if action is to be ensured. If it is a single-point touch switch, the signal fed in — the signal that activates the switch — must be the noise or hum picked

up by the operator. Hence, the single-point touch switch consists essentially of an a.f. amplifier that has a high input impedance, a rectifier and a memory. This is shown in figure 3. In this system the input signal (hum voltage on the skin) is amplified in the input stage, rectified and fed

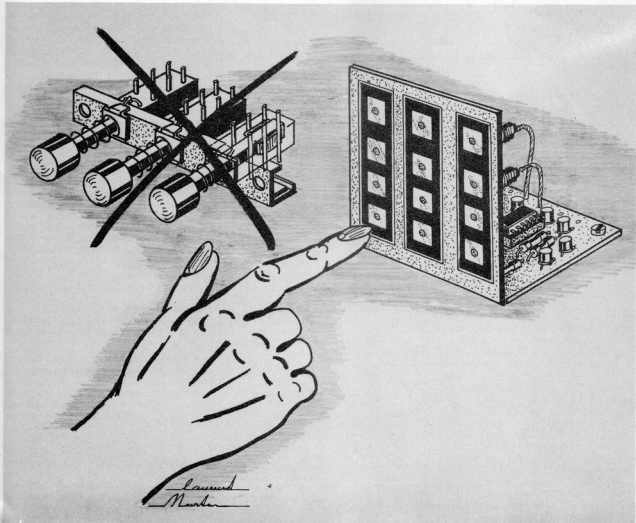

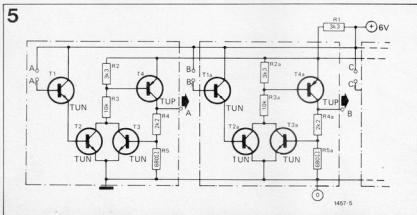
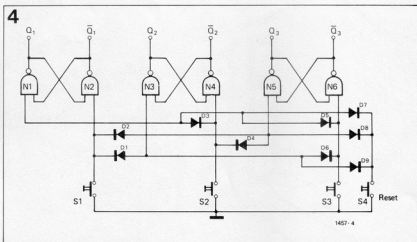
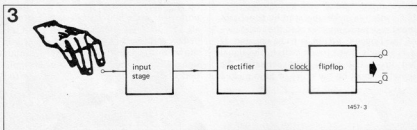
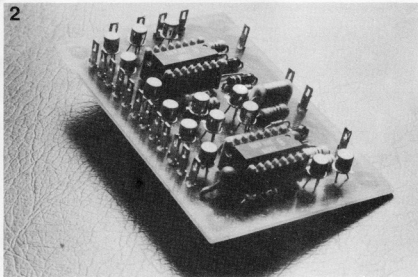

to the clock input of a flipflop. Each time the input point is touched, the flipflop will change to another stable position. A practical circuit in accordance with the block diagram of figure 3 is fairly simple to design.

A TAP (Touch Activated Programmer) that will replace a complete pushbutton unit needs a reset unit between the flipflops of the respective switches. This will ensure that when there are several switches, all except the one operated are reset. This reset can be achieved with diodes as shown in figure 4 with a four-position switch. For simplicity the contacts are shown as push-buttons. S_4 is the total reset button. The three-position switch shown in figure 4 needs nine diodes. In general, the reset circuit requires a number of diodes equal to the square of the number of positions. Hence, an eight-position switch (plus, of course, a total reset) requires 64 diodes. So the system of figure 4 is rather expensive, and the circuit becomes complicated when there are more than four positions. A touch control switch operating without reset diodes is shown in figure 5, points A/A_1 and B/B_1 being the touch contacts. Here reset is achieved by using a common supply resistor R_1 . If one of the switches is 'on', it draws a current of about 1 mA. The voltage drop across R_1 is then 3.3V. As soon as the second switch is operated, this one, too, will want to draw 1 mA. As a result, the voltage across R_1 drops almost to zero, the non-operated switch is cut off and the last switch to be operated remains 'on'. An advantage of such a switching system is that it can be easily expanded with more and more of the same units. There is the drawback, however, that extra components are needed to create 'hard' binary outputs. Consequently, the cost of the switch becomes so high that the financial requirements can no longer be met.

A better reset system uses a one-shot (monostable multivibrator). Each time a switch is touched, this one-shot circuit feeds a short reset pulse to each flipflop. This pulse must be so short that no audible interval occurs in low frequency applications of the switches. Laboratory experiments have shown that touch-control switches with this reset system provide the most reliable circuit. It is for that reason that they are used in the TAP.

Block diagram of the TAP

Figure 6 shows the block diagram of the TAP, points A, B and C being the touch points.

A separate overall reset is provided. Each touch point is followed by an input buffer circuit (IB-1, IB-2 . . .). These amplify the hum voltage on the skin. The input circuits of the touch points A, B and C drive the set (S)-input of the RS flipflops. Since driving the set input of such a flipflop several times in succession will only lead to one change in its binary state, the rectifier circuit shown in figure 3 is not necessary here.

The input circuits also drive the one-shot. If, for instance, point A is touched, a 50 Hz square wave will appear on the S-input of the first flipflop (FF-1). At the

Figure 2. Photograph of the TAP.

Figure 3. Block diagram of a simple touch control switch with one input and two inverse digital outputs.

Figure 4. A switching system with four digital (pulse) inputs and three binary outputs. The system is designed so that in all cases only one binary output assumes a set state whilst the other outputs are in the reset state or are being reset.

Figure 5. A touch control switching system where only one output at a time can be in the set state. This system can be expanded with an unlimited number of touch control switches.

Figure 6. Block diagram of the TAP. The letters FF, OS and IB stand for FlipFlop, One-Shot (= monostable multivibrator) and Input-Buffer.

same time the one-shot produces very short reset pulses. Because these reset pulses to the R-input are short as compared with the square wave at the S-input, the flipflop is not reset immediately after being set. A switch is reset only by operating one of the other two switches or the independent reset. As the block diagram of figure 6 shows, each TAP comprises three switching positions and one total reset. The circuit is designed so that several TAPs can be combined to a maximum of about 14 switching positions plus one total reset.

The RS-flipflop

In the TAP two NAND gates are coupled to form an RS-flipflop (see figure 7).

The S-input of the flipflop is driven from a transistor, that, in the active state, draws the input of the gate to supply zero. In figure 7 this is transistor T_6 , connected to input B, and driven by T_5 . If point D in figure 7 is touched, the hum voltage on the skin will drive T_5 into conduction; T_6 then goes into saturation and draws input B of the NAND gate to '0' 50 times per second. If D is not

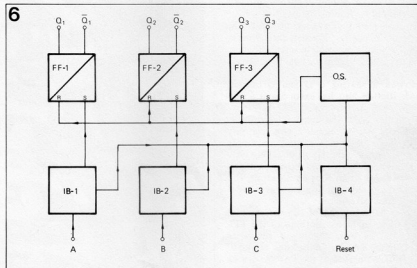

The 7400

The TAP is designed around the integrated circuit type 7400, a quadruple two-input NAND. Actually, the full type number will be SN 7400, S 7400, N 7400, SN 74H00, to name a few; the letters are not so important, however. To gain a good insight into the functioning of the TAP circuit, it is necessary first to take a closer look at this integrated circuit. The part surrounded by the dashed line in figure A represents the internal circuit of a NAND gate, and each 7400 comprises four such gates.

The two emitters of T_1 are the inputs of the NAND gate. When both emitters of T_1 receive a voltage $+V_B$, no current flows through its P-N base-emitter junction. The potential on the base of T_1 rises and the P-N base-collector junction conducts. Hence, here transistor T_1 can be regarded as an assembly of three diodes. The potential on the base of T_2 now rises and this transistor is turned on, so that its collector potential drops sharply. Consequently, T_3 no longer conducts and, at the same time, T_4 is driven into saturation. Point C, the NAND gate output, drops to zero potential (LOW). So when both inputs of T_1 are at $+V_B$ (HIGH), the output is LOW. It is also obvious that leaving the emitters of T_1 'open circuit' is in fact the same as applying $+V_B$.

As soon as one of the emitters of T_1 becomes LOW (logic '0'), the base voltage of T_1 will also drop. As a result, the base-collector junction of T_1 does not conduct, T_2 is no longer driven, and the output (C) will assume a HIGH level.

When the output of the NAND gate is HIGH (logic '1'), the output level is equal to the supply voltage $+V_B$ minus the drop in the diode D, the collector-emitter saturation voltage

Figure A. Circuit diagram of a NAND gate in a 7400 IC.

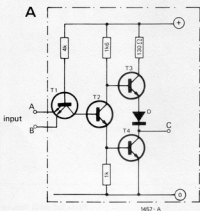

of T_3 and the drop in the 130Ω collector resistance. This output level therefore depends on the load current.

If the output of the NAND gate is LOW (logic '0'), the load current is fed to the supply zero via T_4 . The maximum load current ('sink current') is then determined by the maximum permissible current through T_4 , which is 30 mA for a 7400 IC.

touched, T_6 remains off and the NAND gate sees this as a '1' level.

The circuit diagram of the TAP

Figure 8 gives the circuit diagram of the TAP. It is designed around two ICs. The four NAND gates of IC₁ are used to form two RS-flipflops. The first one consists of the gates N_1/N_2 , and the second one of N_3/N_4 . A third is formed by the gates N_5/N_6 in IC₂. The two remaining gates (N_7/N_8) of IC₂ form the one-shot, which provides the reset pulse. Its pulse width is determined by resistor R_8 and capacitor C_2 . Figure 9 shows an oscillogram of a reset pulse at the output of the one-shot (pin 8 of gate N_7). The pulse width is approximately 400 ns!

As appears from figure 9, the reset pulse is a '0'. The reset pulses are fed directly to the R-input of the three flipflops without diode coupling. This is possible because the emitters of the NAND gates are 'open'.

The set control for each flipflop takes place via the darlington circuit consisting of two transistors described earlier. For flipflop N_1/N_2 these are the transistors T_1 and T_2 . The collector of T_1 is connected direct to the set input of the flipflop. The negative-going pulse on this collector, when point A is touched, is used for driving the one-shot. To achieve a good switching edge, the collector of T_1 is connected to '1' level via resistor R_1 (in the quiescent state). As soon as A is

touched, the collector of T_1 switches from '1' to '0' and back again 50 times per second. Via diode D_1 this signal arrives on resistor R_9 . Consequently, transistor T_8 becomes conductive, and the drive input of the one-shot (pin 13 of gate N_8) is drawn to supply zero, so that the one-shot produces reset pulses 50 times per second.

Resistor R_4 in the base of T_2 prevents this transistor being damaged by static charges on the skin.

To avoid instability of the TAP, a capacitor C_3 is connected across the supply. Capacitor C_1 is provided for automatic reset when the supply is turned on. This is achieved by feeding the positive voltage surge, occurring during switch on, to the base of T_7 via R_7 . Consequently transistor T_7 and T_8 become momentarily conductive, and the one-shot produces a reset pulse.

As well as having a Q and \bar{Q} output, each flipflop also has extra S and \bar{S} outputs. These are intended as active attenuators. In the reset condition an S-output can be regarded as a relatively high-ohmic resistance relative to supply zero. Inversely, the \bar{S} -output is relatively low-ohmic. If, via a series resistor, a digital signal is fed to an S or an \bar{S} output, this S or \bar{S} output will function as a logic-controlled attenuator.

The switching speed of the various outputs is so high that nothing of the TTL character is lost. Figure 10 shows an oscillogram of a switching edge of one of the binary outputs of the TAP. As is seen from this figure, the rise time is less than 10 ns.

The circuit shown in figure 8 can be considered a universal TAP. The points RB (Reset-Bar) and CB (Contact-Bar) provide an extra output for using several TAPs in conjunction with each other.

Table 1 gives the truth table of the TAP, and table 2 gives various specifications.

The printed circuit board

Figure 12 shows the circuit board of the TAP. All the inputs are along the upper edge of the board, and the outputs along the lower edge. The supply terminals and the RB-CB rails are on one side.

Screened cable should be used for the input connections.

TAP applications

A simple TAP application, an on/off switch for a 220 V lamp, is shown in figure 13.

In figure 14 a similar circuit for operating three lamps is shown.

If the diodes D_1 , D_2 and D_3 are omitted from the TAP in figure 14, the result is a triple lamp switch with one common reset. In cases where a triple touch control switch with a common reset is insufficient, more TAPs can be used in conjunction. The RB- and CB-rails of all TAPs used must then be interconnected. Figure 15 gives a simple example. Of course, only one TAP need be provided with a one-shot reset circuit.

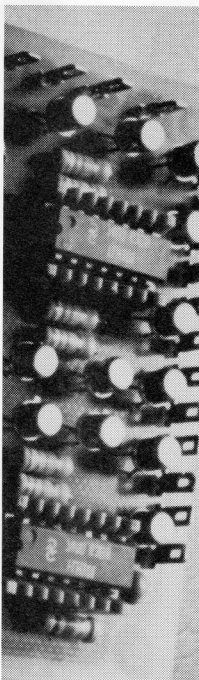

Table 1. Truth table of the TAP

		Q_1	\bar{Q}_1	Q_2	\bar{Q}_2	Q_3	\bar{Q}_3
after switch-on		1	0	1	0	1	0
touch	A	0	1	1	0	1	0
	B	1	0	0	1	1	0
point	C	1	0	1	0	0	1
	reset	1	0	1	0	1	0

positive logic '1' = +5 V

Figure 7. An RS-flipflop built from two NAND gates. The transistors T_5 and T_6 plus resistor R_1 form the 'set' circuit.

Figure 8. The complete circuit diagram of a TAP.

Figure 9. Photographed oscillogram of a one-shot reset pulse. The one-shot produces this pulse each time input A, B, C or the reset is touched. At a prolonged touch of any of the touch points, the one-shot produces 50 such pulses per second.

Figure 10. Photographed oscillogram of one of the binary outputs during switching.

Figure 11. Equivalent block diagram of the TAP circuit.

Parts list with figures 8 and 12.

Resistors:		Capacitors:
R_1, R_2, R_3	= 100 k	C_1 = 270 p
R_4, R_5, R_6, R_7	= 10 M	C_2 = 270 p
R_8	= 1 k	C_3 = 47 n
$R_9, R_{10}, R_{11}, R_{12}$	= 27 k	
R_{13}, R_{14}, R_{15}	= 27 k	

Semiconductors:	
D_1, D_2, D_3	= DUG
$T_1, T_2, T_3, T_4, T_5, T_6, T_7$	= BC 107 or BC 108, BC 109
T_8	= AC 126 or equiv.
$T_9, T_{10}, T_{11}, T_{12}$	= TUN
T_{13}, T_{14}	= TUN
IC-1, IC-2	= 7400 (DIL)

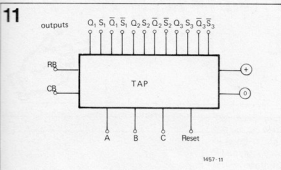
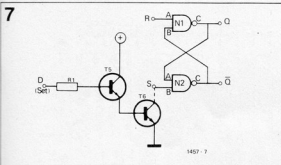
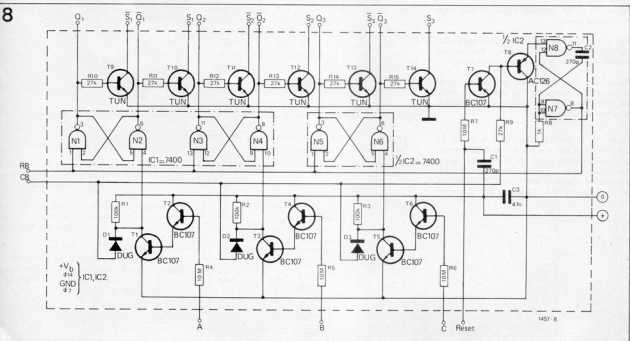
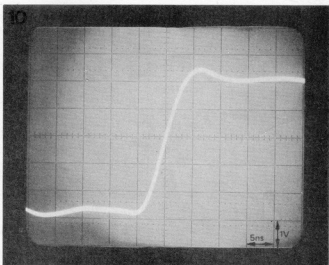
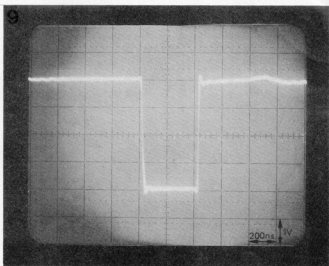
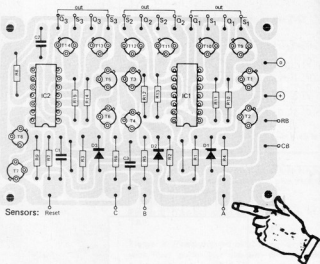
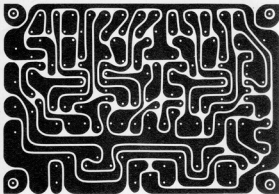

Table 2 TAP specifications

supply voltage	: +4.5 V ... +6.4 V
input impedance (each input)	: > 10 M
response voltage (each input)	: > 1 V (RMS)
response current (each input)	: < 160 nA
maximum response delay	: 20 ms (50 Hz mains)
switching time (each output)	: < 1 μs
output voltage logic '1' (each Q and Q̄)	: > 4.5 V p.p. (V _b = 6 V)
output voltage logic '0' (each Q and Q̄)	: < 150 mV p.p. (V _b = 6 V)
output current logic '1' (each Q and Q̄)	: 0.4 mA
sink current logic '0' (each Q and Q̄)	: -16 mA
required continuous current	: 16 mA (V _b = 5 V)
under no-load conditions	: 20 mA (V _b = 6 V)





12

13

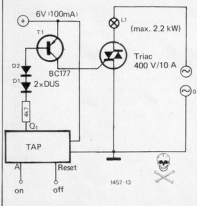
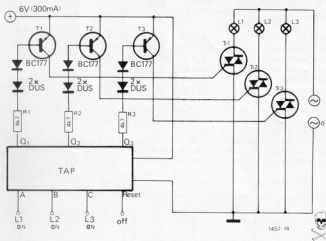

Figure 12. TAP printed circuit board with component lay-out.

Figure 13. The TAP used as a touch-controlled on/off switch for a 220 V lamp. Ensure that the live mains lead is connected to the lamp.

Figure 14. The TAP used as a triple lamp switch. If the diodes D_1 , D_2 and D_3 are omitted from the TAP, the result is a triple switch with one common reset.

14



$$T_{r1} = T_{r2} = T_{r3} = 400 \text{ V}/10 \text{ A}$$

$$L_1 = L_2 = L_3 = \text{max. } 2.2 \text{ kW}$$

Figure 15. If the RB (Reset-Bar) terminals of the two TAPs and the CB (Control-Bar) terminals are interconnected, as shown, the result is a seven-position touch control switch with 6 switching positions and 1 reset. The one-shot can be left out of TAP 1 because TAP 2 already has one.

15

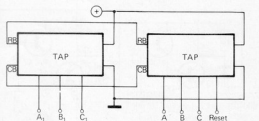

1457-15

flickering flame

The simplest possible flasher device is a bimetal switch. This construction can be found in

'blinker bulbs' and in the starter-switch associated with a fluorescent lamp. The possibility immediately comes to mind of using a fluorescent-lamp starter as a flasher for Christmas-tree or other decorative lights. If one uses more than one starter in some combination of several lamps or lamp-groups, highly varied and interesting effects can be obtained.



Figure 1. Photograph of a partly dismantled fluorescent-lamp glow-starter. Note the suppression capacitor.

Figure 2. The simplest possible flasher circuit consists of a single starter wired in series with a filament-lamp load.

Figure 3. Example of a more complicated arrangement. Two starters and three lamps (or lamp-strings) of unequal wattage will provide a highly variable flickering-effect.

The basic idea is shown in figure 2. The starter is wired in series with the lamp or lamp-string (such as Tree-lights).

When mains voltage is applied across the series combination the inert-gas mixture in the starter becomes conductive and a current-carrying glow-discharge occurs between the electrodes. One of these electrodes is actually a 'bimetal', two thin strips of different metals - having two different thermal expansion coefficients - welded together. Such a bimetal will curl (or uncurl) when it is heated. In the fluorescent-lamp starter the discharge current through the gas provides the heating, and the curling of the bimetal is arranged to cause a short-circuit between the glow-electrodes. This removes the supply of heat, so that the cooling bimetal reopens the circuit a second or two later.

The lamp connected in our arrangement will therefore flash more or less regularly on and off. The current which may be switched by the starter depends on the rating of the lamp for which the manufacturer intended it. The best place to find this rating is the label on the 'ballast' device. Alternatively, assume that if the starter (e.g. Philips type S10, see photo) is intended for fluorescent tubes up to 80 watt rating, that it will safely switch ordinary filament lamps to this amount.

Note that the starter normally becomes 'dormant' when the arc-type gas discharge in the fluorescent tube 'strikes'. This is because the voltage across the steadily

burning arc is too low to allow the starter-glow to re-ignite. In our application there is no such effect, so that the 'starter' will flash its load continuously.

It is however possible to dream up circuits in which more than one starter is combined with a split-up load in a way which makes fuller use of the properties of a given type of device. As an example take figure 3. This circuit will do the wildest things, depending on the individual starters and on the load values.

Suppose that L_2 has the lowest wattage. When the mains is applied it will burn more or less brightly. As soon as one of the starters makes contact, either L_1 or L_3 will come on full and L_2 will go out. When the second starter makes contact all the lamps have the full voltage applied - but almost immediately the first starter will reopen . . .

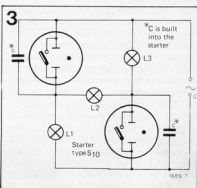
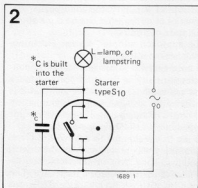

electronic loudspeaker

It is widely accepted that the loudspeaker is the weakest link in the high-quality audio chain. This is particularly the case at the lowest working frequencies due to the difficulty of providing a useful air-load for a radiating diaphragm that has dimensions small compared to the sound wavelength. This compels the manufacturer to adopt clever but more or less expensive constructions for the loudspeaker unit and its enclosure.

The manufacturer has the resources and facilities to tackle the problems at the mechanical-acoustical stage. This article explains that the do-it-yourself approach that provides the best results at the lowest price is invariably the "electronic loudspeaker".

Methods of electronically compensating for the weaknesses of loudspeakers are by no means new. As Harwood recently pointed out, a patent granted in the early 20's already describes a "motional feedback" system.

The basic idea is to somehow derive a signal that depends on the loudspeaker's actual movement and to compare this with the original input signal. The resulting 'error' signal is used to modify the drive to the loudspeaker. One way of obtaining a feedback signal is to extract the voltage that is induced in the loudspeaker's drive-coil when the cone moves.

This extraction of the back-voltage has to be done with great care if the system is to remain stable. Also, not every loudspeaker is suitable for the technique.

The design described in this article has, however, behaved itself properly during many demonstrations.

Apart from the fact that the electronic loudspeaker does not need a specially-mounted pickup-device, which makes it simple to build up, it can be compared to normal applications of the same driver as follows:

a) the lower limit of 'flat' amplitude response is independent of the fundamental resonance-frequency of the driver itself (or of the driver in its enclosure).

b) distortion due to certain mechanical non-linearities in the driver can be considerably reduced.

c) although the frequency response remains 'flat' below the fundamental resonance frequency of the driver in its enclosure, the maximum acoustical power output falls off below this frequency.

It turns out however — as will be explained later — that a 20-watt amplifier produces more than enough sound level for domestic listening situations.

d) a loudspeaker operating in this kind of feedback system can produce good sound at higher as well as lower frequencies, although optimum results can only be obtained when an extended circuit is carefully matched to the individual loudspeaker. On the other hand, the greater cone excursions associated with extended

bass response will aggravate the high-range (Doppler) distortion problem, so that it is desirable to use the electronic loudspeaker only for the woofer-range.

The electronic woofer

The behaviour of a moving-coil woofer in a closed box can be fairly accurately predicted from simple theory (see 'loudspeaker diagnosis'). This theory can be used to find a way to improve the bass response.

If one 'looks into' the loudspeaker terminals one 'sees' a series-connection of two impedances — i.e. a voltage divider. One of these, called the static or 'blocked impedance', is the value measured when the voice-coil is prevented from moving (e.g. fixed with glue). The other impedance arises because of the movement of the coil in the permanent magnetic field and is called the dynamic or 'motional impedance'. We will refer to them as Z_s and Z_d respectively. The radiated sound energy corresponds to the dissipation in a 'radiation resistance' which forms part of Z_d . The objective in operating the loudspeaker is to arrange that this dissipation will be frequency-independently controlled by the input signal applied to the driving amplifier.

The problem is that both Z_s and Z_d vary with frequency, that these variations are by no means the same, and that furthermore the radiation resistance has neither a constant value nor is it a constant proportion of Z_d . Pity the loudspeaker designer! Let us see what can be done about this state of affairs.

The approach adopted for the electronic loudspeaker is to:

a) note that the static impedance Z_s consists essentially of the voice-coil resistance and self-inductance in series and that it is sufficiently well-behaved for elimination by means of an equivalent negative output impedance of the driving amplifier.

b) use this technique to deal with Z_d , and then apply a compensation to the driving signal, to take care of the frequency-dependence of the radiation resistance. This is not too difficult for a loudspeaker acting

as a piston in one wall of a closed box: it turns out (see 'loudspeaker diagnosis' elsewhere in this issue) that a 'flat' frequency response is obtained when the voltage across the radiation resistance is made inversely proportional to the frequency. This can easily be done using a 6dB/octave low-pass network inserted ahead of the amplifier in the bass channel. This network, together with the negative output impedance of the amplifier, forms the basis of the 'electronic loudspeaker'.

Summing it all up it can be stated that the radiated sound energy corresponds to the dissipation in the radiation resistance; that for a constant voltage across this resistance the dissipation will increase in proportion to the square of the frequency; that for a flat frequency response this voltage must therefore be inversely proportional to the frequency — this calls for a 6dB/octave low-pass network; that this voltage can be forced to the required value once the series impedance Z_s has been eliminated by means of a negative amplifier output impedance. The driving amplifier will then automatically deliver the required drive current.

Negative output impedance

A negative output impedance can be achieved by means of the arrangement shown as a block-diagram in figure 1. 'A' in this diagram represents the gain of the driving power-amplifier. The loudspeaker is represented as Z_L , consisting of the impedances Z_s and Z_d in series. Z_f is a feedback current-sensing impedance, connected between the 'cold' loudspeaker terminal and amplifier earth return. The voltage drop across Z_f is found from:

$$\frac{V_Z}{Z_f} = i_0 = \frac{V_0}{Z_L}$$

(since the current through feedback network f is negligible) so that:

$$V_Z = \frac{Z_f}{Z_L} \cdot V_0$$

The output impedance is worked out as follows:

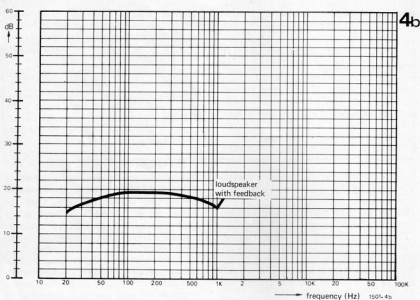
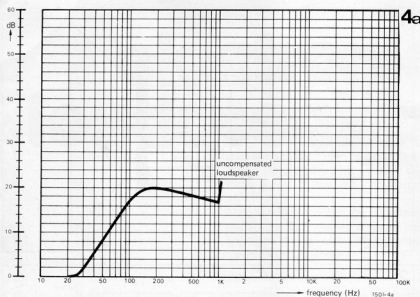

Figure 3. Block diagram of a multi-way system which uses the 'electronic loudspeaker' in the bass channel. Such a system will be described in a further article.

Figure 4. The frequency response of a 5" loudspeaker in a 5" X 5" X 6" (1) closed cabinet, with and without compensation.

$P_0 = 4\pi^2 \times I_d = 4\pi \cdot 9 \cdot 10^{-3} \approx 100$ milliwatts, where we have inserted 3 metres for distance (r) and 10^{-3} watts per metre² for the direct intensity (I_d), i.e. 90 dB. A loudspeaker with 1% efficiency will do this on 10 watts of electrical input — and only 'acoustic suspension' woofers with heavy moving systems are less efficient than this! A 20-watt amplifier for each of two stereo woofer-channels is clearly sufficient.

The driving amplifier

The driving amplifier used in this system must reach a very high standard of performance. Not every 'high fidelity amplifier' automatically satisfies the requirements.

The most important requirement is that the amplifier be unconditionally stable, with any load.

In the compensated system, after all, the apparent amplifier load is the loudspeaker's motional impedance. This appears as a parallel tuned circuit: inductance, capacitance and resistance all in parallel! Worse still, this apparent load is the result of applying positive current feedback around the whole system. . .

We previously described the 'Equa-amplifier', which meets the requirements with an ample margin. It was indeed designed with the electronic loudspeaker in mind. This amplifier, like most 'six-transistor' circuits, has its input and output voltages in-phase. If an amplifier which reverses the signal phase is to be used, it will be necessary to insert a phase reversal in the feedback path. This can be simply achieved by replacing the figure 2 buffer stage by a so-called 'virtual earth' mixer.

The loudspeaker

In principle the loudspeaker and its enclosure do not have to meet any severe requirements. If the best results are to be obtained, attention must nonetheless be paid to one or two details.

The volume of the enclosure will determine the fundamental resonance frequency of the compensated system — and this is the point at which the power response starts to roll off. For normal dom-

imum sound level should be 'reasonable' and 'acceptable' in the 'normal domestic listening situation' (whatever that may be). The very words indicate that this will be pure conjecture — yet it would surprise us if we found ourselves very far off the mark.

For reproduction of 'serious' music (symphony concert, baroque recital etc.) a strong case exists for playback at the same apparent loudness level as that of the original performance. For a typical concert hall the peak loudness level during fortissimo passages varies from about 95 dB at the rear of the hall to about 105 dB near the front. (The reference level for these decibels is the normal threshold of hearing — an intensity of 10^{-12} watts per metre².) The average level of a fortissimo passage is much lower. At the other end of the range, the pianissimo peak level is typically 35 to 45 dB (just far enough above the noise level due to the air-conditioning!) This 60 dB dynamic range can only be tol-

erated in a large hall, where the 'indirect' or 'reverberant' sound field behaves quite differently to that in a domestic listening room. A similar apparent loudness range appears to be achieved in the latter situation when the reproduced dynamic range is about 40 dB — with fortissimo peaks at 90 dB. Most recording companies produce material with a 40 dB dynamic range, which was monitored at this 90 dB fortissimo-peak level. And they should know.

Let us therefore assume that our 'electronic loudspeaker' must be able to produce momentary loudness peaks of 90 dB in typical domestic surroundings. Since the indirect field takes time to build up intensity, it will be the loudspeaker's direct radiation intensity which must be able to reach 90 dB. Assume further that the listener is 3 metres from the loudspeaker, which radiates evenly in all directions (a fair assumption up to about 400 Hz). The required acoustical power is:

3

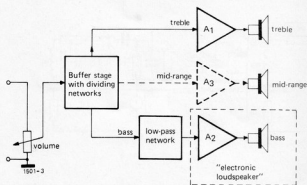

estic listening a volume of 15 litres is adequate. (15 litres = 15 cubic decimetres = 0.5297200050 . . . cubic feet . . . if you must!) If only background music is to be reproduced, the enclosure will do as soon as the driver fits inside it!

The enclosure should also be almost airtight. One way of achieving this is to start with a completely-sealed box, then to drill a small hole (about 2 mm ϕ) in the rear panel. This will enable variations of atmospheric pressure to equalise themselves. The amount of leakage is correct when the cone of the mounted driver takes several seconds to recover position after it has been gently pushed a small amount inwards, momentarily held stationary and then released. (N.B. Amplifier switched off!)

Finally, the walls of the box must be sufficiently 'solid'. They must not vibrate – and therefore contribute to the radiation – under the influence of the strong pressure changes in the driven box. Stiffening ribs may be applied if necessary. Damping material is not strictly necessary; but a single pad of glass-wool or similar material, lath-mounted in the middle of the enclosed volume, will control standing waves in the box. The latter can give audible trouble, particularly if the enclosure is fairly large.

The drive-unit itself should in principle meet three requirements: it must be able to handle sufficient power input; the magnet must be large enough to guarantee an unvarying flux through the entire coil during large excursions of the cone; the cone itself and the front-surround must be reasonably stiff. It must behave as a piston!

Special high-compliance woofers using a rubber front-surround are less suitable for this application, particularly when in a small enclosure. When the cone is driven outwards at high input levels there is a tendency for the surround to be sucked inwards!

The electronic multi-way system

It is best to use the electronic loudspeaker as the woofer in a multi-way system. Figure 3 shows the block diagram of such

an arrangement.

The amplifier A_1 is a small high-quality amplifier (6-10 watts) which drives only the treble loudspeaker(s). If desired the reproduction of mid-range and tweeter-range may be separated. This can be done by means of a dividing network after A_1 or by the use of a separate mid-range power-amplifier A_3 (dotted).

The bass drive-unit and amplifier A_2 together form the 'electronic loudspeaker'. The low-pass step-network described earlier is installed ahead of this amplifier. The combination must meet the requirements mentioned above.

The block diagram finally includes a buffer stage with dividing networks for the bass and treble paths. These networks, like the low-pass step network, are built up from RC sections and buffer circuits.

In a further article we will describe complete two- and three-way systems based on the use of 'equal-amplifiers'. Details will be given of the dividing circuits and measurement results.

(to be continued)

In the text, figures and unavoidable formulae the following symbols have been used:

- Z_s = static ('blocked') impedance of the drive unit
- Z_d = dynamic ('motional') impedance of the drive unit
- Z_L = total impedance of the loudspeaker drive unit
- $-Z_s$ = negative (driving-) impedance
- Z_o = output impedance of the amplifier
- Z_f = feedback sensing impedance
- P_o = radiated acoustical power
- v_o = voltage across the speech coil
- v_e = incoming signal voltage
- v_i = modified amplifier input voltage
- v_f = current-dependent voltage across Z_f
- v_d = feedback voltage
- v_d = voltage across the motional impedance
- v_s = voltage across the static impedance
- R_s = copper resistance of the driving ('voice') coil
- R_f = feedback sensing resistor
- f = feedback factor
- A = gain of the driving amplifier proper
- i_o = output current
- i_d = intensity of the 'direct' loudspeaker radiation

loudspeaker diagnosis

Those who need to understand the underlying theory of the working of moving-coil loudspeakers usually try to read authoritative textbooks (which tend to be thick ones).

Many others who really would like to understand are frightened off by these authoritative textbooks. The present short article, intended to accompany the 'electronic loudspeaker' in this issue, outlines the way in which a knowledge of the basics of electrical engineering can give access to the 'mysteries of the moving-coil'.

For simplicity we will deal with the loudspeaker in a stiff airtight 'acoustic box' (sometimes called an 'infinite baffle enclosure'). The mechanical quantities determining what goes on are: force (f), velocity (u), mass (M), compliance (C) and damping or radiation-resistance (D). The compliance is the reciprocal of 'stiffness' and describes, in this case, the springlike behaviour of the cone as it moves against the suspension to cause pressure-changes in the box.

Electrical engineers describe their systems by drawing 'circuit diagrams' containing resistance, inductance and capacitance – in which applied voltages cause currents to flow (or injected currents cause voltage drops).

It would simplify matters a great deal if we could 'translate' mechanical quantities into equivalent electrical quantities, and draw a 'circuit diagram' of the mechanical system.

To see whether this is possible, let us compare the formulae describing the mechan-

A

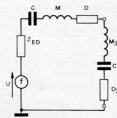
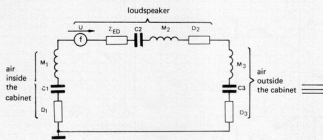

1501-A

al system with those for an electrical circuit:

$$f = M \frac{du}{dt}; u = C \frac{df}{dt}; \text{ and } f = D \cdot u;$$

respectively:

$$v = L \frac{di}{dt}; i = C \frac{dv}{dt}; \text{ and } v = R \cdot i.$$

Comparison of these two sets of formulae suggests the 'translation':

Force (f)	~ voltage (v)
velocity (u)	~ current (i)
mass (M)	~ inductance (L)
compliance (C)	~ capacitance (C)
damping (D)	~ resistance (R)

The textbooks call this the 'electromechanical impedance-type analogy'. A mechanical circuit diagram can be drawn, in which the inductance symbol represents the quantity that 'behaves like' inductance — the mass — and, similarly, damping is represented as resistance and compliance as capacitance. The units are newtons (force) and metres-per-second (velocity); so that circuit values are measured in kilograms (mass), kilograms-per-second (damping) and metres-per-newton (compliance).

The mechanical circuit of the moving-coil loudspeaker (at low frequencies!) in a closed box is given in figure A. The force exerted by the voice-coil is shown as a force-generator (f) with an internal impedance (Z_{ED}) and the 'radiation load' on the cone front as an air-mass (M_2) and a compliance (C_2) in series with a radiation resistance (D_2), which is what takes up the sound power).

It is convenient to 'lump' impedance due to the enclosed volume of air in the box (M_1, C_1, D_1) together with the impedance due to the suspension of the drive-unit itself (M_2, C_2, D_2). The mechanical circuit now simplifies to that of a series-tuned circuit with damping. The resonant frequency is the 'fundamental resonance' of the loudspeaker-in-box. (At frequencies above a few hundred Hertz, other resonances and anti-resonances start to appear — standing-wave modes in the box, the drive-unit's 'edge-dip', flexural wave patterns on the cone surface or 'break-up' — but these complications are fortunately outside the scope of this article.)

The next step is to couple the mechanical circuit of the loudspeaker to an amplifier.

To do this we must succeed in replacing the mechanical force generator (f) by an electrical voltage or current generator. The coupling between the mechanical and the electrical system is described by the formulae:

$$f = B \cdot l \cdot i \text{ and } v = B \cdot l \cdot u,$$

in which B is the magnetic flux and l is the wire length of the voice-coil. Using these formulae we can derive:

$$f = M \frac{du}{dt} \rightarrow Bli = M \frac{d}{dt} \left(\frac{v}{Bl} \right) \rightarrow i = \frac{M}{(Bl)^2} \frac{dv}{dt}.$$

Comparison with the electrical formula:

$$i = C \frac{dv}{dt}$$

shows that in this case

$$\frac{M}{(Bl)^2} \sim C.$$

Mass, which we originally translated as inductance, turns out to be equivalent to capacitance! In the same way it can be shown that compliance is equivalent to inductance, damping is equivalent to conductance ($\frac{1}{R}$), force is equivalent to current and velocity is equivalent to voltage. Finally, a series circuit becomes a parallel circuit and vice versa.

The 'true' electrical circuit diagram for the loudspeaker is shown in figure B. The final step is to substitute, for the current generator, a voltage generator with an additional internal impedance: the amplifier (figure C). For clarity, L_{D1}, C_{D1}, L_{D2} and C_{D2} are represented as one ('dynamic') impedance Z_D . The voltage across this impedance (v_D) is proportional to the velocity of the cone (u) in figure A ($v_D = Blu$) provided B remains constant. This means that if the cone is held stationary (u = 0), this voltage $v_D = 0$. Z_D could be replaced by a short circuit! The impedance of the loudspeaker equals Z_S in this case, the 'static impedance' or 'blocked impedance'. The impedance 'seen' at the loudspeaker terminals therefore has two parts. The 'static' part — which is (theoretically!) independent of any movement of the coil — is simply the series connection of the coil's copper (or aluminium) resistance and the inductance due to parts of the magnetic circuit behaving as an iron core. Since it can only be directly measured by

Figure A. 'Mechanical circuit' of a loudspeaker in which the mechanical elements are represented by equivalent electrical circuit symbols.

Figure B. Equivalent electrical circuit of a loudspeaker. This is derived from the 'mechanical circuit' of figure A by a transition in two stages.

Figure C. Equivalent electrical circuit of a complete system with the amplifier represented by a voltage source with an internal impedance Z_G . The frequency characteristic of this system is determined by the variation of v_D and R_{D2} with frequency.

Figure D. This graph illustrates the total effect. The dashed line shows the influence of the radiation resistance (D_3) on the radiated acoustical power (P_0): a rise of 6 dB/oct up to a certain ('critical') frequency, which is arbitrarily chosen in this graph as 500 Hz (f_2). The dotted line shows the influence of the low-pass filter: a drop of 6 dB/oct above the cut-off frequency (f_1 , arbitrarily chosen as 40 Hz). Finally, the full line shows the result: a 'flat' response between f_1 and f_2 .

preventing coil-movements — for example with cement — this part is often called the 'blocked impedance' (Z_G).

When the coil is permitted to move normally the 'electrodynamical' coupling between the mechanical and electrical circuits give rise to the other part of the loudspeaker's impedance: the parallel-resonant-circuit-with-damping described above. This part is called the 'motional impedance' (Z_D). The resistance in parallel to Z_D (R_{D2}) is derived from D_3 in figure A: the air radiation resistance. This is a true (mechanical) resistance, in other words the acoustical energy $P_0 = u^2 \cdot D_3$, while in the electrical equivalent $P_{el} = i^2 \cdot R$. We have shown that u is proportional to v_D ($v_D = Blu$), so that:

$$P_0 \sim v_D^2 \cdot D_3.$$

Conclusions:

The objective of operating the loudspeaker is to obtain a 'flat' frequency response. This means finding a way to ensure that the dissipation in the radiation resistance

B

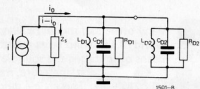

$i \sim f$
 $Z_s \sim Z_{ED}$

$L_{01} \sim C$	$L_{02} \sim C_3$
$C_{01} \sim M$	$C_{02} \sim M_3$
$R_{01} \sim D$	$R_{02} \sim D_3$

C

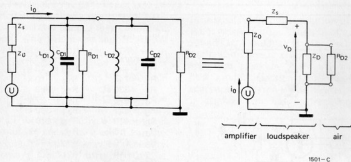

D

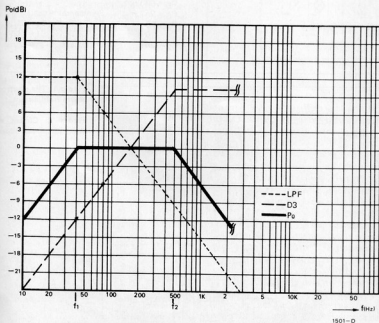

is independent of frequency. This dissipation is affected in two ways:

1) The voltage

$$v_D = \frac{Z_D}{Z_D + Z_s + Z_0} \times v$$

is frequency-dependent due to the impedances Z_D , Z_s and Z_0 .

2) Furthermore, the radiation resistance (D_3) is not constant: it rises proportionally to the square of the frequency up to a certain frequency (usually between 300 Hz and 1 kHz). Above that frequency it remains constant.

The first problem can be countered by arranging for the power amplifier to have a negative output impedance, such that $Z_0 = -Z_s$. In this case

$$v_D = \frac{Z_D}{Z_D + Z_s - Z_s} \times v = v!$$

The variation in radiation resistance can also be compensated in a simple way: an increase in power proportional to the square of the frequency is equivalent to a rise of 6 dB/oct. This can be compensated by a simple 6 dB/oct low-pass filter in front of the amplifier.

When both techniques are used, the resulting frequency response rises at 6 dB/oct up to the cut-off frequency of the low-pass filter, and from there on remains 'flat' up to the frequency where D_3 becomes constant (somewhere above 300 Hz) (see figure D).

This means an almost ideal bass response, independent of the volume of the cabinet! The volume only influences the efficiency of the system, not the frequency response. The demands placed on the loudspeaker are that the magnetic system must be 'good' (the flux must remain constant during all movements of the voice-coil); that the cone and its surround must be sufficiently stiff (to operate as a piston); and that it must be able to handle sufficient power.

The cabinet is only of secondary importance, provided it is stiff and airtight - and provided the loudspeaker fits inside!

1501-D

steam train

Many owners of model railways want their 'world of trains' to be as realistic as possible. A means of imitating the sound of a real steam train is, therefore, more than welcome. This article describes a simple method of building an electronic circuit of few components that will produce the required sound. To add even more authenticity, the rhythm of the steam train sound is regulated automatically and is practically proportional to the speed of the train.

1

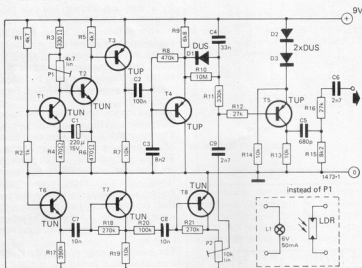

Parts list

Resistors:

R₁ = 4k7
 R₂ = 1 k
 R₃ = 330 Ω
 R₄ = 470 Ω
 R₅ = 4k7
 R₆ = 470 Ω
 R₇ = 10 k
 R₈ = 470 k
 R₉ = 6k8
 R₁₀ = 10 M
 R₁₁ = 330 k

R₁₂ = 27 k
 R₁₃ = 10 k
 R₁₄ = 10 k
 R₁₅ = 8k2
 R₁₆ = 27 k
 R₁₇ = 390 k
 R₁₈ = 270 k
 R₁₉ = 10 k
 R₂₀ = 100 k
 P₁ = 270 k
 P₁ = 4k7 lin.
 P₂ = 10 k, trimmer

Capacitors:

C₁ = 220 μ, 15 V
 C₂ = 100 n
 C₃ = 8n2
 C₄ = 33 n
 C₅ = 680 p
 C₆ = 2n7
 C₇ = 10 n
 C₈ = 10 n
 C₉ = 2n7

Semiconductors:

T₁, T₂, T₆, T₇, T₈ = TUN
 T₃, T₄, T₅ = TUP
 D₁, D₂, D₃ = DUS

3

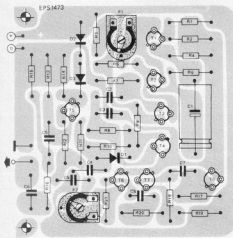
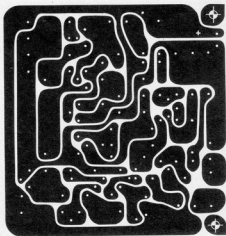

Figure 1. The electronic steam train circuit.

Figure 2. Circuit diagram for power supply.

The circuit

Figure 1 shows the complete circuit diagram. The sound of a real engine is produced by the regular escape of waste steam. This hissing sound is produced electronically by a noise generator. The rapid increase and slow fading of the noise as well as its rhythm, is controlled by an astable multivibrator and a pulse shaper. The output of the noise generator T_6 is amplified by transistors T_7 and T_8 . The amount of noise, or noise level, can be adjusted by means of potentiometer P_2 . The transistors T_1 and T_2 form the astable multivibrator which produces a square wave. The rhythm of the steam sound can be varied by means of P_1 . By coupling the spindle of this potentiometer to the speed control on the supply transformer for the locomotive, the rhythm of the steam sound is automatically controlled by the speed of the train. Should this arrangement be too difficult, the potentiometer can be replaced by a light-dependant resistor (LDR); practically any type of LDR will do. A suitable lamp is then connected in parallel with the power supply for the train and placed with the LDR in an opaque envelope to ensure that other light sources, such as room lighting, have no effect.

The light intensity now depends on the speed of the train; this controls the value of the LDR and this adjusts the rhythm of the sound to match the speed. To ensure satisfactory control, it may be necessary to try several lamps of different wattage. The capacitors C_2 , C_3 and C_4 convert the square wave produced by the astable multivibrator into a certain pulse shape. This pulse drives transistor T_5 quickly into conduction, but cuts it off again at a much slower rate. For a short time, transistor T_5 then feeds the amplified noise signal to the output while amplifying it even more, after which the amplification is reduced slowly. The output signal can be further amplified by means of an external amplifier or radio set.

The supply

The circuit can be fed from a 9 V battery. Figure 2 shows the circuit for a mains supply.

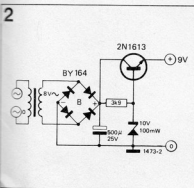

steam whistle

Many model railways still run on 'steam'. For greater realism the steam locomotives are nowadays often fitted with an artificial smoke device. They become even more realistic when an imitation steam whistle is also provided.

In general, electronic imitation of sounds is not so easily done. Analysis of a specific sound by looking at an oscilloscope display, or, better still, with the aid of a spectrum analyser, will make clear just how complicated that sound can be. The spectrum analyser is the clearer, because it displays the various frequency com-

ponents. A steam whistle produces a tone, so that the heart of the circuit must be an oscillator. Secondly, a steam whistle is blown — which means hiss. The circuit must therefore also contain a noise generator. This noise generator must modulate the oscillator. Experiment will determine which method of modulation is to be used.

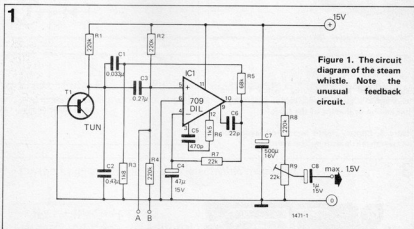

Figure 1. The circuit diagram of the steam whistle. Note the unusual feedback circuit.

ponents with their relative amplitudes. But even given sufficient information about the composition of a sound, its electronic imitation is still no pushover. An accurate imitation usually requires a 'truckload' of circuitry.

An acceptable imitation, however, can be achieved with less complication. The problem in this case is nonetheless the same, how to dream up a suitable circuit. Any attempt to seriously calculate component values is futile, particularly when the sound produced is only an approximation to the original. Then there is always the consideration that a spectrum analyser is not normally readily available, never mind a genuine working steam whistle! One is forced to the conclusion that trial and error is the only available approach.

The circuit

We already know two aspects of the cir-

Assuming that the brute-force excitation of the original steam whistle gives rise to strong overtones, the oscillator will have to be some kind of multivibrator producing a fairly sharp-edged waveform. The selected square-wave oscillator is a 709 in a positive feedback arrangement (and including the usual compensation).

The noise-generator is a reverse-biased base-emitter junction of an NPN transistor. At the supply voltage of 15 V this junction operates in the breakdown region (Zener), producing plenty of noise. Resistor R_1 limits the current to protect T_1 . Since the noise is directly injected into the oscillator feedback path, it causes an irregular frequency-modulation of the square-wave. This irregular jittering of the waveform causes the output to sound piercingly shrill — very like a real steam whistle.

The pitch of the note can be varied by

changing the values of the capacitors. The influence of the noise generator is largely determined by R_3 . Varying R_3 adjusts the shrillness of the note, but one must bear in mind that it will also affect the pitch to some extent.

Keying possibilities

Due to the fact that almost any disturbance of the circuit has an influence on the pitch, it is not possible to key the whistle by electronically switching the feedback. The best approach turned out to be short-circuiting the points A and B. This disturbs the biasing of the 709, causing the oscillation to stop immediately.

This keying can be done, of course, with a push-button (break contact) — but it is much more interesting to let the locomotive switch the whistle on and off. This can be achieved with a Light Dependent Resistor in two operating modes. The

whistle sounds either when light falls upon the LDR or when the LDR is shielded. Figure 2 gives the circuits for both modes. When the whistle is to be started by illumination of the LDR, the circuit with T_2 is sufficient. If the triggering is to be done by shadowing the LDR, T_3 and R_{13} have to be added. The board layout in figure 3 enables either arrangement to be used. In the first case, a jumper lead is required between the base and collector connections for T_3 .

The positioning of the LDR is very important. When a shadow is to trigger the whistle, the illumination under 'silent' conditions has to be very strong.

A real train usually gives a warning signal just before entering and leaving a tunnel.

An LDR positioned under the track will arrange for the model train to automatically do the same. The same applies to a level-crossing. Here once again an LDR mounted under the track, between

the sleepers, will greatly add to the realism of a model railway.

Sometimes a quite weak shadow is enough to start the circuit. Some adjustment of the sensitivity is possible with R_{12} . When the ambient light level in the 'playroom' is on the low side, it will be necessary to shine extra light on the LDR. The same applies to the circuit that whistles upon illumination. To start the circuit it is necessary to distinctly illuminate the LDR.

Figure 2. The optical keying switch for the steam whistle, which will respond to either illumination or shading of the LDR.

Figure 3. Printed circuit board and layout for the steam whistle with optical switch.

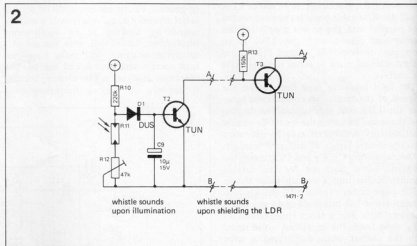

3

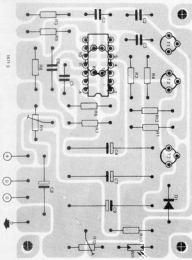
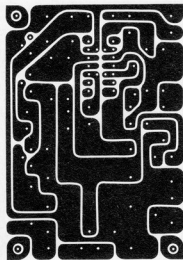

Parts list

Resistors:
 $R_1, R_2, R_4, R_6, R_{10} = 220 \text{ k}$
 $R_3 = 1 \text{ k}$
 $R_5 = 68 \text{ k}$
 $R_6 = 1 \text{ k}$
 $R_7 = 22 \text{ k}$
 $R_9 = 22 \text{ k}$, trimmer
 $R_{11} = \text{LDR } 03$
 $R_{12} = 47 \text{ k}$, trimmer
 $R_{13} = 150 \text{ k}$

Capacitors:
 $C_1 = 0.033 \mu$
 $C_2 = 0.47 \mu$
 $C_3 = 0.27 \mu$
 $C_4 = 47 \mu/15 \text{ V}$
 $C_5 = 470 \text{ p}$
 $C_6 = 22 \text{ p}$
 $C_7 = 500 \mu, 16 \text{ V}$
 $C_8 = 1 \mu, 15 \text{ V}$
 $C_9 = 10 \mu, 15 \text{ V}$

Semiconductors:
 $T_1 \text{ t/m } T_3 = \text{TUN}$
 $D_1 = \text{DUS}$
 $IC_1 = 709$

ELEKTOR
PUBLISHERS LTD.

Y E E L S

reading
your magazine has aroused
my interest.
Please send me more details
about:

- advertising in your magazine
- becoming a stockist for your magazine and books
- selling your printed circuit boards

SUBSCRIBERS

Assignment

Requirements

ELEKTOR
PUBLISHERS LTD.

Elektor Publishers Ltd., Publishers of up to date electronic magazines and books, designers and suppliers of printed circuit boards, need, at short notice,

for the English edition of their electronic magazine.

To read and study the editorial contents, during their spare time, so that they will benefit from this in their profession; and to deal with practical electronics, with or without help from friends or colleagues, using the clear instructions and the printed circuit boards available.

Interest in the practical, easily-built circuits published in Elektor.

Those who are interested in this spare time pursuit can become subscribers for 4 or 8 issues, by filling in this form. After receiving the acceptance note, intending subscribers can forward the appropriate pecuniary reward to Elektor.

Please send me an acceptance note for a subscription to

- 8 issues 1975 (January - December) price - £ 3.60
- Trial subscription to 4 issues 1975 (January - August) price - £ 2.00

Coming soon in

ELEKTOR

Electronic loudspeaker systems

MOSTAP

Modulation systems

Cybernetic beetle

DIL LED probe

TUP TUN tester

let

ELEKTOR

surprise you



Another
example of how Hewlett-Packard
technology brings down the price
of professional instruments.

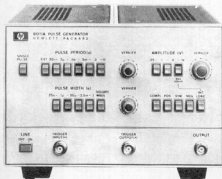

8011A PULSE GENERATOR

Output Amplitude: $\pm 16V$

Repetition rate: 0.1 Hz - 20 MHz

Output formats: norm/symm/comp

Square wave mode

High $Z/50 \Omega$ selectable source

PRICE: £ 262*

To select train of 1-9999 pulses:

8011A opt 001: internal preset pulse counter

PRICE: £ 419*

For more details please return coupon below, or
contact Hewlett-Packard Ltd.,
224 Bath Road, Slough, Bucks SL1 4DS.

To Hewlett-Packard Ltd., Dept. EL2
224 Bath Road, Slough, Bucks SL1 4DS.

Full details, please, on the 8011A Pulse Generator and
other cost effective professional instruments from
Hewlett-Packard.

Name

Position

Company/Institution

Address

*Excluding VAT. Correct at time of going to press.
Import duty included for United Kingdom

HEWLETT  PACKARD

Sales, service and support in 172 centres in 65 countries.

You name the electronic part you're looking for... Van Dam Elektronica has got it for you... ex-stock!

Like the contents of Elektor - always in the forefront of the very latest trends and developments - Van Dam Elektronica is keeping abreast of the needs of the times by constantly updating its stocks.

Be sure to follow the example of so many re-owned companies and benefit from our huge stocks, our large call orders for prominent plants and of our international relations.

Whether it's a few thousand transistors, diodes, scr's, zener diodes, integrated units, resistors or capacitors you want, your supply problem is promptly solved by our special team of experts. So be sure to contact Van Dam Elektronica in Rotterdam, Holland and state your specific problem.

You can do so by telex: 25336 damel nl or by telephone. From Great Britain dial 01031 - 10670022.

If required, write us a letter stating any electronics wishes you may have.

BV Techn. Handelmaatschappij



VAN DAM
ELEKTRONICA

Spoorsingel 49, P.O. Box 450,
Rotterdam, Holland.
Telephone: 010-670022-Giro: 295550.

Another

example of how Hewlett-Packard technology brings down the price of professional instruments.

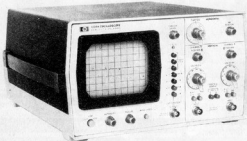

1220A OSCILLOSCOPE

Bandwidth: DC to 15 MHz
Sensitivity: 2mV/cm to 10V/cm
Vertical accuracy: 3%
Sweep: 0.1µs/cm to 0.5 s/cm
 CRT 8 x 10 cm internal graticule
 TV-trigger, beam-finder

PRICES: 1220A dual channel £ 409*
 1221A single channel £ 322*

For more details please return coupon below, or contact Hewlett-Packard Ltd., 224 Bath Road, Slough, Bucks SL1 4DS.

To Hewlett-Packard Ltd., Dept. EL1
 224 Bath Road, Slough, Bucks SL1 4DS.

Full details, please, on the 1220A Oscilloscope and other cost effective professional instruments from Hewlett-Packard.

Name _____

Position _____

Company/Institution _____

Address _____

*Excluding VAT. Correct at time of going to press.
 Import duty included for United Kingdom

HEWLETT  PACKARD

Sales, service and support in 172 centres in 65 countries.

The new Rank WOW & FLUTTER Meter Type 1742

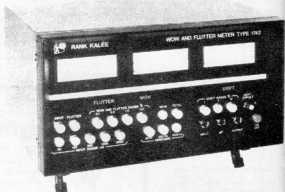

Fully transistorised
 for high reliability

Versatile
 Meets in every respect all current specifications for measurement of Wow, Flutter and Drift on Optical and Magnetic sound recording/reproduction equipment using film, tape or disc

High accuracy
 with crystal controlled oscillator

Simple to use
 accepts wide range of input signals with no manual tuning or adjustment

Two models available:
 Type 1742 'A' BS 4847: 1972 DIN 45507
 CCIR 409-2 Specifications
 Type 1742 'B' BS 1988: 1953 Rank Kalee Specifications

For further information please address your enquiry to

Mrs B. Nodwell
 Rank Film Equipment, PO Box 70
 Great West Road, Brentford
 Middlesex TW8 9HR

Tel: 01-568 9222-Telex 24408- Cables Rankaudio Brentford

 **RANK FILM EQUIPMENT**
 EK-11 FOR FURTHER DETAILS

SIEMENS

Microwave tubes. Just a small part of our capability in electronics.

Siemens high-power travelling wave tubes are specified in Aerials 1, 2 and 3 of the Post Office Earth Station for satellite communication at Goonhilly Down.

The YH 1045 travelling wave tube can provide up to 6 kW CW RF power in the frequency range 5.925 to 6.425 GHz and is used as the final amplifier in the transmitter system.

Siemens teams of professionals have been responsible for the development and installation of these and similar tubes in other earth stations around the world.

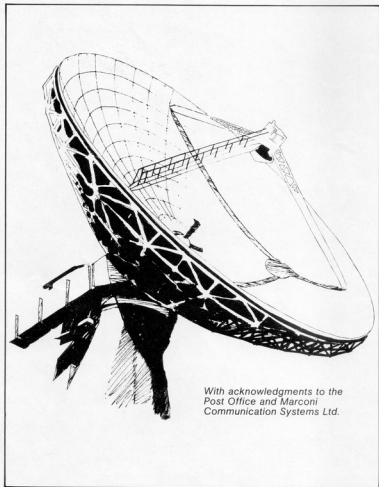

With acknowledgments to the Post Office and Marconi Communication Systems Ltd.

This expertise enables Siemens to meet the growing demand for new generation microwave tubes – but this is just one part of the total capability in the design, development and manufacture of Siemens electronic components and equipment. Siemens now provide a major source of microwave tubes for customers throughout the world, as well as complete ranges of devices for all sections of the electronics industry.

Siemens Limited, Great West House, Great West Road, Brentford TW8 9 DG, Middlesex, Telephone 01-568 8281. Telex 23176.

Profit from the Siemens experience.

The life and efficiency of any piece of electronic equipment can rest entirely on the solder used in its assembly. That is why for utmost reliability leading electronic manufacturers in the USA and in 106 other countries throughout the world insist on using Ersin Multicore Solder. It's the solder they have depended on for consistent high quality for more than 30 years.

If you are not already using Ersin Multicore Solder it must be to your advantage to investigate the wide range of Specifications which are available. Besides achieving better joints – always – your labour costs will be reduced and subsequently savings in overall costs of solder may be possible.

There are well over 1,000 Specifications, made to all International Standards to choose from, and here are just a few of the special solders that we manufacture:

Savbit Alloy – dramatically reduces erosion of copper wires and printed circuits and also reduces the wear of soldering iron bits.

96S Silver Solder – highest strength soft solder. Melting point 221°C. Bright and non-toxic. Replaces high temperature brazing alloys.

95A alloy – Melting range 236–243°C. For electrical connections subjected to peak temp. of approx. 240°C.

H.M.P. alloy – Melting range 296–301°C. Highest melting point soft solder for high service temperature applications.

T.L.C. alloy – Melting point 145°C. Lowest melting point Ersin Multicore solder for making joints on top of other solders and for heat sensitive components.

L.M.P. alloy – Melting Point 179°C. For soldering silver plated surfaces such as ceramic capacitors and soldering gold.

Alu-Sol Multicore Solder – for soldering aluminium.

Arax acid-cored solder – for non-electrical applications or pre-tinning of parts of difficult solderability (flux residue must be removed) which can then be assembled with Ersin Multicore Solder.

Write for Technical Bulletins, on your Company's letterhead, for products which interest you to:



Multicore Solders Ltd.

Maylands Avenue,
Hemel Hempstead, Hertfordshire, HP2 7EP
Tel: Hemel Hempstead 3636 | Telex: 82363

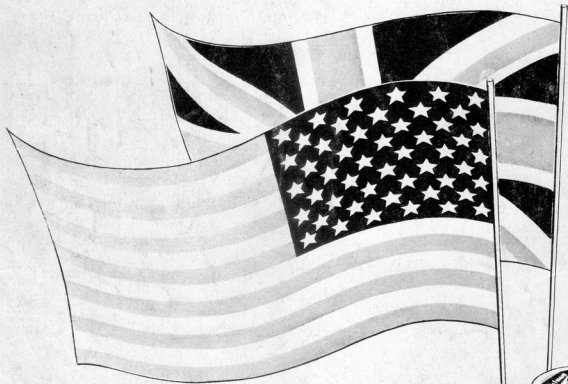

**Why have leading
USA manufacturers specified
British made Ersin Multicore
solder for over 30 years?**

